

**MILITARY
EXPLOSIVES**

This copy is a reprint which includes current pages from Changes 1 through 4.

**HEADQUARTERS, DEPARTMENT OF THE ARMY
SEPTEMBER 1984**

Change)
)
No. 4)

HEADQUARTERS
DEPARTMENT OF THE ARMY
Washington, D.C., 25 September 1990

MILITARY EXPLOSIVES

TM 9-1300-214, 20 Sep 84, is changed as follows:

1. Remove old pages and insert new pages as indicated below. New or changed material is indicated by a vertical bar in the margin of the page.

Remove pages

A
8-49 and 8-50
8-125 and 8-126

Insert pages

A
8-49 and 8-50
8-125 and 8-126

2. File this change sheet in front of the publication for reference purposes.

By Order of the Secretary of the Army:

CARL E. VUONO
General, United States Army
Chief of Staff

Official:
THOMAS F. SIKORA
Brigadier General, United States Army
The Adjutant General

Distribution:
To be distributed in accordance with DA Form 12-34-E, requirements for TM 9-1300-214.

Change)
)
No. 3)

HEADQUARTERS
DEPARTMENT OF THE ARMY
Washington, D.C., 30 September 1988

MILITARY EXPLOSIVES

TM 9-1300-214, 20 Sep 84, is changed as follows:

1. Remove old pages and insert new pages as indicated below. New or changed material is indicated by a vertical bar in the margin of the page. Revised chapters are indicated by a vertical bar adjacent to the title.

Remove pages

A page
i (ii blank)
12-1 thru 12-30
Index 1 and 2
Index 5 thru 26

Insert pages

A page
i (ii blank)
12-1 thru 12-6
Index 1 and 2
Index 5 thru 26

2. File this change sheet in front of the publication for reference purposes.

By Order of the Secretary of the Army:

CARL E. VUONO
General United States Army
Chief of Staff

Official:

R.L. DILWORTH
Brigadier General United States Army
The Adjutant General

Distribution:

To be distributed in accordance with DA Form 34B-R.

Change)
)
No. 2)

HEADQUARTERS
DEPARTMENT OF THE ARMY
Washington, D.C., 30 January 1987

MILITARY EXPLOSIVES

TM 9-1300-214, 20 Sep 84, is changed as follows:

1. Remove old pages and insert new pages as indicated below. New or changed material is indicated by a vertical bar in the margin of the page. Revised chapters are indicated by a vertical bar adjacent to the title.

Remove pages

A page
i(ii blank)
12-1 thru 12-49(12-50 blank)
15-3 and 15-4
Index 11 and Index 12
Index 21 and Index 22

Insert pages

A page
i(ii blank)
12-1 thru12-30
15-3 and 15-4
Index 11 and Index 12
Index 21 and Index 22

2. File this change sheet in front of the publication for reference purposes.

By Order of the Secretary of the Army:

JOHN A. WICKHAM, JR.
General United States Army
Chief of Staff

Official:

R.L. DILWORTH
Brigadier General United States Army
The Adjutant General

Distribution:

To be distributed in accordance with DA Form 12-40A-R, General Information Applicable to all Organizations which have a Conventional Munitions Mission.

Change)
)
No. 1)

HEADQUARTERS
DEPARTMENT OF THE ARMY
Washington, D.C., 30 November 1985

MILITARY EXPLOSIVES

TM 9-1300-214, 20 Sep 84, is changed as follows:

1. Remove old pages and insert new pages as indicated below. New or changed material is indicated by a vertical bar in the margin of the page.

Remove pages

None
6-1 and 6-2
9-3 and 9-4
9-7 and 9-8
15-3 thru 15-6

Insert pages

A page
6-1 and 6-2
9-3 and 9-4
9-7 and 9-8
15-3 thru 15-6

2. File this change sheet in front of the publication for reference purposes.

By Order of the Secretary of the Army:

JOHN A. WICKIAM, JR.
General, United States Army
Chief of Staff

Official.

MILDRED E. HEDBERG
Brigadier General, United States Army
The Adjutant General

Distribution:

To be distributed in accordance with DA Form 12-40A-R, General Information Applicable to all Organizations which have a Conventional Munitions Mission.

LIST OF EFFECTIVE PAGES

When applicable, insert latest change pages and dispose of superseded pages in accordance with applicable regulations.

**TOTAL NUMBER OF PAGES IN THIS PUBLICATION IS 361
CONSISTING OF THE FOLLOWING:**

<i>Page No.</i>	<i>*Change No.</i>	<i>Page No.</i>	<i>*Change No.</i>
Cover	0	12-6 blank	0
A	4	13-1 thru 13-11	0
i	3	13-12 blank	0
ii blank	0	14-1 thru 14-15	0
1-1	0	14-16 blank	0
1-2 blank	0	15-1 and 15-2	0
2-1 thru 2-23	0	15-3 and 15-4	2
2-24 blank	0	15-5	0
3-1 thru 3-5	0	15-6	1
3-6 blank	0	15-7 thru 15-15	0
4-1 thru 4-17	0	15-16 blank	0
4-18 blank	0	A-1 thru A-13	0
5-1 thru 5-10	0	A-14 blank	0
6-1	1	B-1 and B-2	0
6-2 thru 6-4	0	Index 1 and Index 2	3
7-1 thru 7-20	0	Index 3 and Index 4	0
8-1 thru 8-49	0	Index 5	3
8-50	4	Index 6 and Index 7	0
8-51 thru 8-124	0	Index 8 and Index 9	3
8-125	4	Index 10 and Index 11	0
8-126 thru 8-135	0	Index 12 thru Index 19	3
8-136 blank	0	Index 20	0
9-1 thru 9-3	0	Index 21	3
9-4	1	Index 22	2
9-5 thru 9-7	0	Index 23	0
9-8	1	Index 24 thru Index 26	3
9-9 thru 9-12	0	Authentication page	0
10-1 thru 10-13	0		
10-14 blank	0		
11-1 thru 11-17	0		
11-18 blank	0		
12-1 thru 12-5	3		

*Zero indicates an original page.

MILITARY EXPLOSIVES

REPORTING OF ERRORS

You can help improve this manual. If you find any mistakes or if you know of a way to improve the procedures, please let us know. Mail DA Form 2028 (Recommended Changes to Publications and Blank Forms) or DA Form 2028-2 located in the back of this manual direct to: Commander, US Army Armament, Munitions and Chemical Command, ATTN: AMSMC-MAY-T(D), Picatinny Arsenal, NJ 07806-5000. A reply will be furnished to you.

	Paragraph	Page
CHAPTER 1.	INTRODUCTION	1-1 1-1
2.	HISTORICAL DEVELOPMENT OF ENERGETIC MATERIAL	2-1 2-1
3.	GENERAL CHARACTERISTICS AND CLASSIFICATION OF ENERGETIC MATERIALS	3-1 3-1
4.	CHEMISTRY AND PHYSICS OF ENERGETIC MATERIALS	4-1 4-1
5.	PROPERTIES AND TESTS OF EXPLOSIVES	5-1 5-1
6.	PROPERTIES AND TESTS OF PROPELLANTS	6-1 6-1
7.	UNITED STATES PRIMARY EXPLOSIVES	7-1 7-1
8.	UNITED STATES BOOSTER AND SECONDARY EXPLOSIVES	8-1 8-1
9.	UNITED STATES PROPELLANTS.....	9-1 9-1
10.	UNITED STATES PYROTECHNICS	10-1 10-1
11.	FOREIGN ENERGETIC MATERIALS.....	11-1 11-1
12.	TOXICITY OF ENERGETIC MATERIALS	12-1 12-1
13.	DETECTION AND IDENTIFICATION OF ENERGETIC MATERIALS	13-1 13-1
14.	PACKING, MARKING, STORAGE, AND SHIPMENT OF ENERGETIC MATERIALS.....	14-1 14-1
15.	DISPOSAL, DESTRUCTION, DECONTAMINATION, AND DEMILITARIZATION OF ENERGETIC MATERIALS	15-1 15-1
APPENDIX A	A-1
APPENDIX B	B-1
INDEX	Index 1

*This manual supersedes TM 9-1300-214, 28 November 1967, including all changes.

CHAPTER 1 INTRODUCTION

1-1. Purpose. This manual is intended for use as a text for instruction or as a reference source in the field of energetic materials. Only the materials of interest in conventional armaments are covered; nuclear armaments are not.

1-2. Scope. Chapter 2 is a history of the field of energetic materials. Chapter 3 divides the energetic materials field into three categories: explosives, propellants, and pyrotechnics. Chapter 4 discusses the principles of chemistry and physics pertinent to the energetic materials field. Chapter 5 is a description of the tests used to evaluate explosives. Both mandatory safety tests and tests used in the selection of particular compounds among the many explosive compounds are covered. Chapter 6 contains a description of the tests used to evaluate propellants. Chapter 7 presents detailed information about the compounds that are used by the United States as initiating explosives. A discussion of priming compositions is also included. Chapter 8 presents detailed information about the

compounds that are used by the United States as booster and secondary explosives. Chapter 9 provides a discussion of those mixtures of materials that are used as propellants. Chapter 10 discusses the field of pyrotechnics. Foreign energetic materials are covered in Chapter 11. Safety and toxicity considerations are discussed in Chapter 12. Basic methods used to identify and detect energetic materials are presented in Chapter 13. Chapter 14 presents information pertinent to the packing, marking, storing, and shipping of energetic materials. Chapter 15 discusses disposal, destruction, decontamination, and demilitarization of energetic materials. Pertinent data on explosives and propellants are tabulated in Appendix A. Tables A-1 through A-8 allow rapid comparison of the important characteristics of the material. The bibliography is contained in Appendix B. An index for all material covered, referencing both paragraph and page numbers, concludes the contents of this manual.

1-1(1-2 blank)

CHAPTER 2

HISTORICAL DEVELOPMENT OF ENERGETIC MATERIAL

2-1. Introduction.

a. Purpose. This chapter describes the development of energetic material in chronological order.

b. Scope. This history is mainly concerned with military applications of energetic material, however some important nonmilitary uses are also discussed.

c. Relationship of Development to Science and Technology. Developments in the energetic material field are generally the result of a close relationship between basic research and technology. Advances in basic research provide new materials and new applications. The use of the new materials and new methods of application, as well as ideas from other fields, advance technology or even create new technology. The advancement of technology gives an impetus to further research. For example, the shaped charge effect was discovered in 1888. Little use of the principle was made until World War II, when technological advances made the tank a major battle weapon. At the present time, significant progress is being made in lessening the effect of a shaped charge on armor. This will require further development in energetic materials and their applications to defeat the newer types of armor.

d. Interrelationship Among Explosives, Ammunition, and Weapons.

(1) Explosives are the materials that detonate. They may be used independent of, or form a part of, ammunition. For military management purposes, the two are controlled as one category of weapons or armaments.

(2) Weapons are instruments of any kind used in fighting. We may consider weapons as the tools used in warfare. The development of these tools is the art or science of weaponry. Weaponry includes use of clubs, stones, slings, axes, spears, darts, javelins, bows and arrows, shields, body armor, etc. for hunting and fighting. Later, siege weapons such as catapults and ballista (the forerunners of cannon) were developed to hurl large stones and other missiles at fortifications. Better weapons created the need for a special group of artisans called metalworkers and metallurgists. The metalworkers began shaping the weapons from metals. The metallurgists practiced the art or science of extracting metals from their ores, refining them, and preparing them for use.

e. Discoveries, Inventions, Developments. Historians often disagree as to who was the first to discover, invent, develop, or use a new theory, characteristic, device, or material. Authenticating this information is a difficult task, for the records and terminology used to record these facts may be misleading. What has been published and used as an official source in subsequent documents may have been taken from an unreliable source. The history of energetic materials is particularly full of such examples. For example, who invented black powder or gunpowder? And, when was gunpowder first used? Sometimes the answer is that several or many people or nations were all involved at the same time.

2-2. Early Use of Flame, Incendiaries, and Smoke.

a. Flame and Incendiaries. Flame and incendiaries are the oldest chemical weapons dating back to the caveman's use of flames and burning coals to drive off animals and enemies. In Biblical times, armies attacking and defending fortified cities threw upon each other burning oils and flaming fireballs consisting of resin and straw. In 424 BC, the Spartans successfully employed a prototype of the flamethrower against a Greek fort in Delium. Attaching a pot filled with burning pitch, coals, and sulfur to a hollow log, they used bellows to blow a hot jet of flame which set fire to the city walls and routed the defenders. Incendiary compositions of pitch, sulfur, hemp or flax, and resinous wood were used in the Trojan Wars about 360 BC. Centuries later, the Romans used similar materials in fire bombs or fire pots, which they catapulted over the walls of besieged towns. To set fire to wooden forts they used hollow, perforated arrows filled with incendiary materials, which were ignited just before being shot. The most famous of the incendiary mixes was "Greek Fire," which was prepared by Kallinikos of Heliopolis in Syria to enable the Byzantine fleet to defeat the Caliphate Navy in 668 AD. The exact formula for Greek Fire is unknown. However, the formula is believed to be a mixture of sulfur, naphtha, pitch, resin, and quicklime, which ignited and burned fiercely upon contact with water. The Greek Fire was apparently forced by water, under high pressure, through tubes or siphons. The violent reactions and high pressure ejected the burning incendiary mixture toward the enemy ships. For the next six centuries, the Byzantines used Greek Fire to thwart the Moslem and subsequent Russian sieges of Constantinople. Chinese

manuscripts as early as 969 AD mention fire arrows, fire lances, and incendiary "rockets." But with the exception of Greek Fire, such weapons had little impact on warfare until World War I.

b. Smoke. While history tells us that screening smoke was employed in early conflicts, the results of these isolated incidents were always too uncertain to justify the adoption of smoke as a recognized agent of warfare. In fact, prior to World War I dense clouds of smoke generated by the black powder used in battle had become a definite nuisance. These clouds obscured the field of vision, interfered with aiming and firing, and hampered the movement of troops. More recently, these very same characteristics have been exploited tactically by the planned employment of screening smoke munitions.

2-3. Invention of Fireworks and Black Powder.

a. Fireworks. Fireworks are devices that produce displays of lights, noise, or smoke by the combustion of explosive compositions. Fireworks are managed under that group of ammunition designated as "pyrotechnics." Those who ply this art are called "artificers." Some historians credit the Chinese with being the first true artificers. In the reign of Haiao Tsung of Nan Sung (1169-1189 AD), true fireworks made their debut. They were similar to those used today. The first fireworks were made of incendiary materials with various powdered minerals added to color, or to increase the light or smoke effect. Not until the invention of black powder were the artificers able to generate the displays with which we have become familiar today, such as Roman candles, rockets, fire crackers, serpentines, whistles, and stars. The French, in particular, became very adept at civil pyrotechnics by the 17th and 18th centuries. Civil pyrotechnics are generally limited to fireworks used for public display, signaling, or rescuing.

b. Black Powder. Authorities differ upon the origin of black powder accrediting in turn the Chinese, Hindus, and Arabs. In 1249 AD Roger Bacon, an English monk, recorded a formula for black powder saltpeter (7 parts), charcoal (4 parts), and sulfur (4 parts). Although Bacon was not the inventor, his were probably the first truly scientific experiments with this explosive. Sulfur and charcoal had been used in incendiary compositions for many centuries. Saltpeter (potassium nitrate) appears in nature but requires refining to supply the proper amount of oxygen to ignite the black powder mixture. Bacon's knowledge of purified saltpeter probably came from the Arabs who obtained this information from the

Chinese about 1225 AD. Bacon mentioned in his writings that the ingredients of black powder were used in firecrackers made in various countries of the world.

2-4. Introduction of Gunpowder In Europe.

a. Invention of Guns and Gunpowder. The age of gunpowder began early in the 14th century with the invention of the gun, which consisted of a metal tube from which a projectile was discharged by the explosive force of black powder. Guns and gunpowder provided a new means of propelling stone, iron, or lead balls with greater force than catapults or slings. The discovery of the usefulness of black powder for accomplishing mechanical work may be considered the real beginning of the history of explosives. When ignited by a torch, a loose charge of black powder above the borehole of a gun served as a priming composition. A train of black powder in the borehole advanced the ignition to set off the propellant charge of black powder in the gun tube. The Chinese and Europeans evidently became aware of this application of black powder about the same time. Because Chinese developments did not keep pace with those in Europe, the Europeans have been credited with inventing and developing guns and gunpowder. The earliest mention of black powder on military supply lists was in 1326 AD. Also at that time, a Latin manuscript called "On the Duties of Kings," written by Walter de Milemete, King Edward III's chaplain, included the first known illustration of a cannon.

b. Manufacture of Gunpowder. Roger Bacon's black powder recipe was not for gunpowder. Different proportions of saltpeter, charcoal, and sulfur were required to propel missiles from the early cannon and firearms. In the mid 12th century, John Arderne, an Englishman, gave the proportions of saltpeter, charcoal, and sulfur as 6:2:1, the same as recommended by Marcus Graecus around 1275 and by Albertus Magnus in 1300. The Germans, who some scholars claim invented gunpowder and guns around 1313 (i.e., the legendary Berchtold Schwarz), were using a mixture of 4:1:1 in 1350. The ingredients were ground, mixed, and used in a fine powder or meal. At first, the materials were mixed in a mortar using a pestle operated by hand and were later mixed by horse power. Later, improvements in machinery mixed gunpowder with rollers on a marble slab and with wooden stamps. Mixing black powder was considered a highly technical art and a dangerous one too. Sometimes the final mixing was done at the gun site to reduce the hazard of stores exploding. Nevertheless,

the records of towns and armies during the early days of gunpowder contain many references to accidental explosions. Other mostly useless ingredients, such as amber, alcohol, camphor, wine, urine, arsenic, and sal armoniac, were added to the recipe to improve stability, reduce absorption of moisture, and to prevent crumbling. Depending on the weapon or the use, some countries varied the proportions of saltpeter, charcoal, and sulfur. For example, the French at one time made six different mixes one strong and one weak each for pistols, muskets, and cannons. Different mixes have been used for blasting, mining, and sporting weapons. In 1895, most countries, including the USA, adopted the English standard 75: 15: 10 (saltpeter: charcoal: sulfur), which had been in effect since 1781. This standard is generally used for all arms, the only difference being in the size of the grains.

2-5. Developments Between the 15th and 18th Century.

The development of energetic materials from 1400 to 1800 were restricted mainly to improvements in the manufacture of black powder and related applications. By 1400, iron cannons, bound by iron hoops to keep them from bursting, and iron cannon balls were coming into use. At the end of the 14th century, a hand gun was invented that weighed 4.5 kilograms (10 lbs) and fired lead shot. One man carried the gun, which was mounted on a stand and aimed at the enemy. This weapon evolved into the arquebus or harquebus, a hand gun with a bent stock and a forked staff to support the barrel while firing. A lit match or fuse of serpentine black powder was used to ignite the propellant powder charge through a touch hole in the breech (closed end) of the gun barrel. Other important events or developments during this period are as follows:

a. 1425. Coming, a new process for making black powder into grains instead of the finer serpentine gunpowder, was invented. Coming consisted of wetting black powder to form a paste, which was then pounded into a cake. The cake was broken into small lumps by hand and sifted. The resulting pieces, which were called corned powder, absorbed less moisture and were more suitable for use in cannons than the serpentine powder. Flame from the priming powder was distributed more efficiently by the larger grains. This resulted in a more complete explosion and reduced fouling.

b. 1540. Standard gunpowder grain sizes for pistols, muskets, and cannons were adopted by the French. They discovered that less powder was needed to propel a projectile if the grain size was controlled. By using uniform, slow-burning grains they were able to control the pressure of the explosion in the gun, and thereby reduce the hazard of blowing up the gun. This discovery also led to improvements in gun design.

c. 1560. Linen or paper bags containing gunpowder were used for charging cannons.

d. 1578. An instrument for testing gunpowder was devised by Bourne of England. Until then, the only test was to burn a small quantity to see how much residue would be left. The testing device consisted of a small metal cylinder with a heavy metal lid on a hinge. The lid was prevented from falling by a ratchet, and the angle to which the lid rose when powder was fired inside the cylinder measured the strength.

e. 1588. Explosive shells were used at the siege of Bergen op-Zoom and Wachtendonck, Holland by the Dutch. The shells were made from hollow iron balls filled with gunpowder. The gunpowder was ignited by a fuze consisting of a hollow tube filled with slow burning serpentine powder, and timed to burn 14 to 20 seconds, corresponding to ranges of 914 to 1830 meters (1000 to 2000 yards) for mortar fire. The knowledge for making this fuze was brought to the Dutch by an Italian deserter from Parma.

f. 1590. Cartridges with ball and powder combined were introduced for small arms.

g. 1602-1604. Fulminating gold, later used as a priming explosive, was invented by Johann Tholden, a Dutch chemist in the employ of the British Navy.

h. 1611-1632. An improved paper cartridge was developed during the rule of Swedish King Gustavus Adolphus, thus increasing the rate of fire for firearms used in the Thirty Years' War.

i. 1613. Blasting powder is reported to have been used in German mines to blast rocks. Less saltpeter and more charcoal and sulfur were used in blasting powder than in gunpowder.

j. 1627. An improved instrument for testing black powder was devised by Curtenbach. This consisted of a heavy conical shot, which rested on the mouth of a small mortar and could travel vertically upwards along a stretched wire provided with a series of catches to stop the shot from falling.

k. 1627. Black powder was used to blast ore in the royal mines at Schemnitz, Hungary following experiments by a Hungarian engineer, Kaspar Weindl. Using black powder for this purpose was slow to be accepted because saltpeter was expensive, boring instruments were not available, and safety hazards from mine gases and cave-ins were increased.

l. 1628. Gold fulminate priming explosives for torpedoes were invented by J. Thollen for the British Navy.

m. 1647. Testing the strength of gunpowder, by firing a ball from a mortar and measuring the distance the ball travelled, was proposed by Master-Gunner Nye in his "Art of Gunnery." This mortar test was adopted by France and other countries soon afterward.

n. 1654. Ammonium nitrate was first prepared by J. R. Glauber, a German chemist.

o. 1679. Blasting powder was used on a large scale in the construction of the Mal pas Tunnel, Canal de Midi, France.

p. 1684. Glazing process for gunpowder was introduced. Rough gunpowder corns were glazed by tumbling them in large wooden drums until the grain surfaces were smooth. Graphite was added to coat the grains. Glazed gunpowder was less hygroscopic and flowed more easily than the unglazed gunpowder.

q. 1735. Antimony sulfide and arsenic sulfide were used by Ruggieri of Italy in pyrotechnic mixtures for brilliant fireworks displays at Versailles.

r. 1738. The closed bomb for measuring the pressure generated by gunpowder fired in a closed vessel was designed by d'Antony of Italy.

s. 1742. The ballistic pendulum, which determined the velocity of a projectile's impact by measuring the recoil of a struck pendulum, was invented by Benjamin Robins, an English mathematician. Robins showed that air resistance on a moving projectile at high velocities is greater than the resistance at low velocities. Robins also developed the first practical chronograph, an instrument for measuring and recording short durations of time, and improved on a closed bomb for testing the power of an explosion.

t. 1771. Picric acid was first prepared by Pierre Woulfe, a French chemist, by treating silk with nitric acid. Picric acid is an aromatic nitro compound which was used as a yellow dye until its explosive properties were discovered in 1871.

u. 1784-1788. Potassium chlorate was prepared in its pure state by Claude L. Berthollet, a French chemist who discovered its detonating properties. His idea of using potassium chlorate instead of potassium nitrate in black powder was abandoned after a disastrous explosion during manufacture in 1788.

Berthollet also prepared fulminating silver in 1788.

v. 1784-1789. Compact black powder grains were obtained by pressing the cakes with screw presses before corning at Faversham, England.

2-6. Nineteenth Century Development. Modern energetic materials technology began with the nineteenth century. New energetic materials began to displace the black powder formulas that had been the choice for use in weapons, ammunition, and blasting for

over 350 years. The discovery of new materials or the practical application of previously known materials (for example, picric acid) greatly influenced the design and performance of weapons and ammunition. In turn, the rapid development of weapons and ammunition, and the increased demands of new and expanding industries further accelerated the search for more effective, less expensive materials. During the nineteenth century, more powerful propellants (such as smokeless powder), better primers, various boosters or detonators, and new high explosives were introduced. There were significant advancements in the science and technology of weapons and ammunition, too. Among these were improved explosive (Congreve) rockets (later adapted for signaling and illumination), rifled arms, revolvers, magazine-loading rifles, machine guns, revolving turrets, armored naval vessels, percussion caps (encapsulated primers), metallic cartridges, time fuzes and impact fuzes for artillery shells, rifled breech-loading field artillery, obturation devices, and spring and hydropneumatic recoil mechanisms for artillery. Modern mass production began when Samuel Colt, an American gunsmith, first manufactured standard rifle and revolver parts. Mass production of small arms ammunition began when G. Moore Peters used the first cartridge-loading machinery at his factory in Ohio. Nineteenth century developments of energetic materials follow.

a. 1800. Mercury fulminate was discovered by Edward Howard, an English chemist, who described its detonating properties in a paper before the Royal Society.

b. 1801. Fireworks formulas containing metal salts and ammonium chloride were published by C. F. Ruggieri, an Italian artificer. These salts produced brighter flames because volatile metal chlorides were formed during the combustion reaction.

c. 1807. The principle of using mercury fulminate as a primer was patented by Rev. Alexander J. Forsyth of Aberdeenshire, Scotland.

d. 1823. Chlorates, discovered by C. F. Berthollet in 1786, were first used in fireworks by John Cutbush, an English artificer.

e. 1825. Benzene, creosote, and naphthalene were isolated from coal tar (obtained from bituminous coal) by Rev. Dr. Clayton in England. Most of his products were later nitrated to produce explosives, such as trinitrobenzene and nitronaphthalenes.

f. 1826. Aniline was first prepared by Unverdorben. Later, nitration of aniline resulted in the very powerful explosive called tetranitroaniline.

g. 1831. Safety fuse for blasting was invented by William Bickford of Cornwall, England. The Bickford fuse consisted of a core of black powder tightly wrapped in textiles (mainly jute yarn). The timing, or burning time, for a given length of fuse was very accurate and consistent. This fuse soon replaced the less reliable fuses which were made of straws or quills filled with black powder, thus greatly reducing the hazard of accidental explosions in mining or construction. Later, the Bickford safety fuse was waterproofed by applying a coat of asphalt covered with either a textile or plastic.

h. 1832. Ammonium perchlorate was first prepared by E. Mitscherlich, a German chemist, who also nitrated benzene and toluene in 1833 or 1834.

i. 1833. Nitrostarch was discovered by Henri Braconnot, a French chemist, while dissolving starch in concentrated nitric acid to form a flammable nitric acid ester of starch. This is considered to be the beginning of modern high explosive technology.

j. 1837-1838. Nitrated paper, soluble in ethyl alcohol, and nitrated cotton fibers, insoluble in ethyl alcohol, were prepared by Prof. Theophile Jules Pelouze, a French chemist. These products were highly combustible.

k. 1841. Ammonium picrate was first prepared by Marchand, and was used in 1869 by Brugere as a propellant.

l. 1843. Picric acid, discovered but not identified by Peter Woulfe in 1771, was rediscovered by A. Laurent who found that some of the salts were explosive.

m. 1845. Guncotton was prepared by Christian F. Schoenbein, a German chemist, while at the University of Basel, Switzerland. Upon nitrating cotton with mixed nitric acid and sulfuric acid, he demonstrated that the resulting nitrocellulose was up to four times as powerful as black powder for blasting. The guncotton burned without leaving an ash. Schoenbein also prepared the first nitrosugar, which deflagrated suddenly and violently when heated to a certain point. Schoenbein and R. Boetter of Frankfurt, Germany, who had discovered guncotton independently, obtained patents in 1846 and 1847 under the title: "Improvement in Preparation of Cottonwool and Other Substances as Substitutes for Gunpowder." Serious accidental explosions during early attempts to manufacture guncotton in 1847 delayed its acceptance as an explosive; however, guncotton eventually became accepted universally for use in blasting and for smokeless powder when mixed with nitroglycerin.

n. 1846-1847. Nitroglycerin, an ester of glycerin and nitric acid, was invented by Asconio Sobrero, an Italian chemist. Because nitroglycerin is very sensitive to slight shocks, commercial use was delayed until the invention of dynamite and blasting gelatin. Nitroglycerin was also used later to make smokeless powder.

o. 1847. Mannitol hexanitrate or hexanitromannitol was first prepared by A. Sobrero, but the explosive properties were not examined until 1878 when N. K. Sokoloff of Russia investigated these characteristics.

p. 1847. Cyanuric triazide was first prepared by Auguste A. T. Cahours, a French chemist.

q. 1850. A testing device for measuring explosive pressure in cannons was developed by Col. George Bomford of the US Ordnance Department. Bomford inserted pistol barrels in holes drilled along the gun tube and measured velocities of bullet blowout. Based on these data, the weight of guns could be reduced.

r. 1850. An improved testing device for measuring explosive pressures in cannons was designed by LTC Thomas J. Rodman of US Ordnance Department. Pistons with punch-type ends were installed at intervals on the cannon and were forced by the explosion of the propellant into copper blocks. Measuring the depth of the indentations indicated the relative pressures along the length of the gun tube. Rodman also developed a process of casting guns hollow and cooling them from within. The Rodman process put the metal surrounding the bore of the gun under a permanent compressive strain that greatly increased the gun's resistance to interior pressures.

s. 1853. Nitroglycerin absorbed in magnesia was developed by V. F. Petrushevskii, a Russian officer, for use in mining gold in Siberia. This was a precursor of dynamite.

t. 1857-1858. Sodium nitrate deposits found in Chile were originally converted to saltpeter (potassium nitrate) by reaction with potassium chloride, which was also in plentiful supply. Lammont du Pont, an American industrialist, introduced a new formula for black powder using sodium nitrate in lieu of potassium nitrate. Black powder containing potassium nitrate was called blasting powder A, and black powder containing sodium nitrate was called blasting powder B. Blasting powder B was less expensive and more hygroscopic, which made it more suitable for blasting. Powder formulas were considered more suitable for firearms, safety fuses, and fireworks.

u. 1858. Diazo compounds were discovered by Peter Griess, who also prepared dinol or diazodinitrophenol.

v. 1859. Ethylene oxide, ethylene glycol, and ethylene glycol ether were prepared by Charles A. Wurtz. A century later, ethylene oxide was used in fuelair explosives (FAX) developed by the US Armed Forces. Diethylene glycol was also developed simultaneously in 1859 by Wurtz and A. V. Laurenco.

w. 1860. A caseless propellant, consisting of cakes of compressed black powder cakes or grains with perforations, was developed by T. J. Rodman while working at Frankford Arsenal, Philadelphia. This led to the use of grains shaped into hexagonal prisms about 2.54 cm (1 inch) long and 2.54 cm (1 inch) across. Perforations and grooves in the grains channel the flame from the explosion. As the grains burn inward from the prism surfaces and outward from the perforations, the burning gases flow continuously, thereby permitting the explosive energy to build up gradually until the maximum power is exerted as the projectile leaves the muzzle of the gun. This acceleration imparts a more efficient thrust to the projectile and extends the range of the gun.

x. 1861. Guanidine was formed by the oxidation of guanine by Strecker. Guanine is a derivative of guano, which was formed from manure, especially that of birds and bats.

y. 1863. Trinitrotoluene (TNT) was prepared by J. Willibrand, German scientist. Although TNT was used for many years in the dye industry, TNT was not used as an explosive until 1904. Thereafter, TNT became one of the most used high explosives.

z. 1862-1866. Nitroglycerin production plants were designed for commercial applications by Alfred Bernard Nobel, a Swedish chemist, based on studies conducted with his father, Emmanuel, in 1859-61. In 1862, they built their first plant at Heleneborg, Sweden. Despite the tragic loss of his brother Emil in an explosion at that plant in 1864, Alfred erected two more plants in 1865 and another in 1866.

aa. 1865. Magnesium was first used for pyrotechnics.

bb. 1865. Nitrocellulose was purified by Sir Frederick A. Abel, an English chemist, who also successfully manufactured granulated nitrocotton. Abel pulped, washed, and compressed the nitrocellulose into blocks, sheets, discs, and cylinders, which were particularly useful for blasting.

cc. 1865. Smokeless powder, used as a sporting propellant, was invented by Schultze, a Prussian officer,

2-6 through nitrating wood, washing the wood with a dilute solution of sodium carbonate, and drying.

dd. 1866-1867. Dynamite was invented by A. Nobel by absorbing nitroglycerin (75) in kieselguhr (diatomaceous earth) (25). Kieselguhr, an inactive ingredient, stabilized the nitroglycerin, and made dynamite a much safer explosive to handle and use.

ee. 1867. The fulminate blasting cap, a device consisting of mercury fulminate in a copper tube used to detonate explosives, was invented by A. Nobel. This cap was crimped to one end of a safety fuse (e.g. Bickford fuse), and then inserted into the dynamite cartridge.

ff. 1867. Ammonium nitrate, pulverized and mixed with sawdust or charcoal, was proposed as an absorbant for nitroglycerin by J. H. Norribin and C. J. Ohlsson, Swedish inventors.

gg. 1868. Dry compressed guncotton was detonated with a mercury fulminate detonator by E. A. Brown, an English chemist, who also discovered that wet guncotton could be exploded by the initiation of a small quantity of dry guncotton. This important discovery, on the principle of a booster explosive, led to the use of large blocks of wet guncotton in naval mines with comparative safety.

hh. 1869. Dynamites with an active base were patented by A. Nobel. To create an active base dynamite, Nobel mixed nitroglycerin with combustibles (sawdust, charcoal, rosin, and starch), and oxidizers (sodium nitrate or potassium nitrate). This led to a more efficient explosive than guhr dynamite.

ii. 1870. Ohlsson and Norribin's patent for ammonium nitrate dynamite was purchased by A. Nobel, who subsequently began production of ammonium nitrate dynamite.

jj. 1871. Sprengel explosives, which consisted of mixing various combinations of oxidizing agents (chlorates, nitrates, and nitric acid) with combustibles (nitronaphthalene, benzene, and nitrobenzene), were patented by Hermann Sprengel, a German chemist. Oxidizing agents and liquid fuel were mixed on site before using.

kk. 1875. The "Explosives Act" was passed by the British Government after a disastrous explosion at Birmingham killed 53 persons. The Explosives Act established Inspectors of Explosives, who were given the power to inspect all magazines and factories to ensure that operations were carried out in a reasonably safe manner. As a result, the number of deaths in explosives factories was greatly reduced. The provisions of this act have been adopted by many other countries.

ll. 1875. Gelatinous dynamites and blasting gelatins were patented by A. Nobel.

mm. 1877. Nitroguanidine was first prepared by Jouselin, but was not used in propellants until 1900.

nn. 1879. Tetryl, a booster explosive, was first prepared by Michler and Meyer of Germany.

oo. 1879. Ammonium nitrate gelatins, known as ammonogelatins, were patented by A. Nobel.

pp. 1882. Brownorcocoagunpowderwasmade by the Germans using partially burned charcoal from rye straw. The grains were made in single, perforated hexagonal or octagonal prisms. Brown powder was of higher quality, but was more sensitive to friction than black powder. The United States used brown powder during the Spanish-American War.

qq. 1883. Tetryl was synthesized from picryl chloride and potassium methylnitramine by van Romburgh, a German chemist.

rr. 1883-1884. Colloided rifle powder was prepared by Max von Duttonhofer by nitrating brown charcoal before mixing the ingredients. This brown powder was adopted by the German Army in 1884.

ss. 1884. Smokeless powder, for military rifles, was invented by Paul Vieille of France. This powder was a completely colloided single-base nitrocellulose propellant. The French Army adopted Vieille's Poudre B. in 1866.

tt. 1884-1885. High-speed photographic cameras were used for ballistic studies by Eugene Mach and P. Salcher of Austria.

uu. 1885. Two flashless powders, ammonpulver and amidpulver, were patented and made by Gaens of Hamburg from ammonium nitrate, potassium nitrate, and charcoal.

vv. 1885. The Hell Gate blast in New York Harbor used 34,000 kg (75,000 lbs) of dynamite, and 11,000 kg (24,000 lbs) of potassium chlorate soaked in nitrobenzene (rack-a-rock) to remove Flood Rock, a menace to navigation. This was the largest amount of explosives used in a single blast until then.

ww. 1885-1888. Eugene Turpin, a French scientist, patented the process of melt-pouring picric acid into artillery shells as a high explosive filler. Sprengel had discovered that picric acid could be initiated by a powerful detonator, but had not exploited this knowledge. The French Government adopted a high explosive shell designed by Turpin using a picric acid filler. They designated the picric acid filler as melinite. In 1888, the British adopted picric acid, which they called lyddite as an high explosive filler.

xx. 1888. The shaped charge effect was accidentally discovered by Charles E. Munroe, an American scientist, at the Naval Academy. Munroe

discovered that a concave-shaped explosive charge pierces a steel plate.

yy. 1888. Cyclotrimethylene trinitrosamine was discovered by Griess & Harrow and by Mayer, yet was not used until the Germans, who called it R-salz, used the composition in World War II.

zz. 1888. Ballistite, the first double-base smokeless propellant, was prepared by Alfred Nobel by replacing camphor with nitroglycerin. In 1889, Nobel prepared ballistite from collodion cotton and nitroglycerin using a solventless method.

aaa. 1888-1889. Cordite, the second successful double-base smokeless propellant, was prepared by Dr. W. Kellner in F. Abel's English laboratory. Sir James Dewar, British chemist and physicist, and Abel patented cordite for the British Government, which adopted cordite as a military propellant named Cordite Mark I or CSP (cordite smokeless powder).

bbb. 1890. Tetranitrocarbazole, used in igniter and pyrotechnic compositions, was first prepared by Karl Graebe, a German chemist. The current method of preparation was developed in 1912 by the Leopold Cassella Company in Frankfurt, Germany, a division of the Interessen Gemeinschaft (I. G.) Farben corporation.

ccc. 1889-1890. The development of explosive devices was greatly enhanced by the work of Theodor Curtius, German Nobel prize laureate, who discovered hydrazine in 1889 and hydrogen azide in 1890. He subsequently suggested to the German military the use of metal azides for primer application.

ddd. 1892. Tetranitrooxanilide was prepared by A. G. Perkin, an English scientist, and used as a component in black powder type explosives and pyrotechnic compositions.

eee. 1894. Butanetriol trinitrate, used a half century later as an explosive plasticizer for nitrocellulose, was first prepared by Wagner and Ginsberg.

fff. 1895. Liquid oxygen explosive (LOX), carbon black packed in porous bags and dipped in liquid oxygen, was introduced by Karl P. G. von Linde of Germany. LOX was widely used by Germany during World War I, and in the United States Midwest for strip-mining in the 1950's.

ggg. 1896. A layered smokeless propellant, which was prepared by glueing and compressing together several layers of different components, was patented by A. B. Bofors, Nobelkrut of Sweden. The outer layers were slow-burning, while the burning speed increased progressively towards the inner layers.

hhh. 1897-1898. Cheddite, an explosive for blasting consisting of potassium chlorate or perchlorate mixed with a nitro compound and castor oil, was invented in England by E. Street. Cheddite derives its name from Chedde, France, where it was made.

iii. 1899. Potassium dinitrobenzofuroxan, used in priming compositions, was first prepared by P. Von Drost.

jjj. 1899. Cyclonite (RDX) was first prepared by Henning of Germany. Henning used RDX, which he called Hexogen, for medical purposes. The first to recognize the value of RDX as an explosive was E. Von Herz of Germany. The first to prepare RDX in quantity was G. C. Hale of Picatinny Arsenal, NJ, in 1925. However, it was not until World War II that the most important work in manufacturing processes and applications of RDX was done.

kkk. 1899. Aluminized explosives, containing aluminum to increase the performance of explosives, were first proposed by R. Escales of Germany and were patented by G. Roth. Ammonal, their first, contained ammonium nitrate, charcoal, and aluminum.

2-7. Twentieth Century Development through World War I (WWI).

This period saw the use of cordite smokeless powder and repeating rifles by the British during the Boer War (1899-1902) in South Africa; large scale naval battles and full-scale use of machine guns in the Russo-Japanese War (1904-1905); and the introduction of submarine warfare, armored tanks, aerial bombing of civilians by dirigibles, and strafing and bombing by aircraft during World War I (1914-1918). World War I saw concentrated machine gun fire, artillery barrages, firing long ranges from railroad guns and from large guns on battleships, firing torpedoes, laying mines, using depth charges in anti-submarine warfare, and signaling and illuminating with flares. Soldiers were issued steel helmets and gas masks for individual protection.

a. 1900. Cordite smokeless powder, used by the British in the Boer War, caused excessive corrosion in gun barrels. As a result, the formula for cordite was changed to reduce the amount of nitroglycerin from 58% to 300/0 and to increase the amount of nitrocellulose to 65% with the amount of mineral jelly remaining at 5%.

b. 1900. Picric acid (British lyddite) shells were used in the Boer War but did not detonate completely. This was attributed to faulty construction of the detonators.

c. 1900. The Contact Process for manufacturing concentrated sulfuric acid and oleum was discovered by

Badische Anilin-und Sodafabrik of Germany. This process was less expensive than the chamber method previously used. As such acid was required for mixed nitric-sulfuric acid to nitrate aromatic hydrocarbons to polysubstitution, trinitrobenzene and trinitrotoluene (TNT) could be inexpensively manufactured.

d. 1900. Chromatography, a physical method of separation in which the components are partitioned between two phases, was invented simultaneously and independently by American geologist D. T. Day and Russian botanist M. S. Tsvet. The qualitative method of separation of ingredients by adsorption was known for centuries.

e. 1900. Regular-delay electric blasting caps for rotational shooting (0.5 to 12 seconds) developed.

f. 1901-1904. A trinitrotoluene (TNT) manufacturing process consisting of three phases was developed by C. Haussermann of Germany. This method, which proved to be more economical than direct nitration of toluene to TNT, was used in the United States until World War II. The German industry adopted this process in 1902, when they adopted TNT as the filler for high explosive shells. They also used TNT for demolition purposes, replacing picric acid.

g. 1902. Detonating cord, developed in France, was improved, leading to adoption in the United States by the Ensign-Bickford Company in 1912.

h. 1902. Antifreeze for dynamite was researched extensively in many countries following a disastrous explosion during defrosting dynamite in Greisnau, Germany. The problem of producing a satisfactory antifreeze remained unsolved until S. Nauckhoff of Sweden published his work in 1905, listing requirements for a satisfactory antifreeze, and compounds which met these requirements.

i. 1903. A muzzle-flash suppressor using vaseline with 1-2% sodium bicarbonate was proposed by Rottweil Fabrik of Germany. This was replaced in 1905 by soap or rosin.

j. 1904. The Obermueller Stability Test, which consisted of heating 1-2 grams of nitrocellulose in a small tube under vacuum at 135-140° and measuring the pressure of evolved gas by vacuum manometer, was introduced.

k. 1904-1905. Methyl picrate (2,4,6-trinitroanisole) was patented for use in smokeless propellants. The powder consisted of an equal amount of methylpicrate and pyrocellulose.

i. 1905. Nitrostarch was produced in a stable form. Nitrostarch is similar to nitrocellulose but is lower in strength. Nitrostarch does not cause headaches from skin contact as do TNT, nitroglycerin, dynamite, and many other explosives.

m. 1906. Various substituted ureas, called centralites and akardites, were developed at the Central Laboratory for Scientific and Technical Research at Neubabelsberg, Germany, for chemical stabilizer application in smokeless powders.

n. 1906. Lead azide was proposed by Col.

A. A. Solonina of Russia for use in compound detonators (initiating explosives) in lieu of mercuric fulminate.

o. 1906. Hexanitroazobenzene was prepared by E. Grandmougin and H. Lehmann of France, and recommended by Tenny L. Davis for use in boosters.

p. 1907. Diphenylamine, designated as poudre B, was approved as a stabilizer for French naval cannon propellants and other large caliber guns. This stabilizer replaced amyl alcohol after the disastrous explosion in 1907 of the battleship *lena*.

q. 1907. Mixed glycol esters, such as dinitroacetin with dinitroformin, were patented as dynamite antifreeze by Vezio Vender of Italy.

r. 1908. A detonating cord (cordeau detonant) containing TNT instead of blackpowder was patented in France. This detonating cord had a detonation velocity of 4,880 meters (16,000 feet) per second.

s. 1909. Ammonium picrate (Dunnite or Explosive D) was standardized in the United States as a bursting charge for armor-piercing (AP) shells. These AP projectiles could be fired through 12 inches of armor plate, and could be detonated on the far side by an insensitive primer.

t. 1909. Low-nitrated aromatic hydrocarbons, because of their stability and insensitivity to shock and to ignition, began to be used in coal mining explosives compositions.

u. 1909. Solventless powder (or propellant) was discovered by Brunswig and Thieme of Germany, although many others contributed to the development of such propellants.

v. 1910. Preparation of 2,3,4,6-tetranitroaniline, a powerful explosive, was patented by Flurschein. This explosive was used during World War II by the Germans and Japanese.

w. 1910. Tetracene was first prepared by K. A. Hofmann in Germany. More extensive studies of the compound were conducted in 1931 by Rinckenbach and Burton.

x. 1910-1913. Laminated solventless propellants were prepared by Dr. C. Claessen, a German scientist.

Making propellants into large solventless grains was less time consuming than making solvent propellants.

y. 1912. TNT was adopted as the standard bursting charge in high explosive shells for the field artillery of the US Army.

z. 1912. Nitroisobutylglycerol trinitrate or trimethylol nitromethane trinitrate, used as an explosive gelatinizer for nitrocellulose, was first prepared by Hofwimmer.

aa. 1912-1913. Tetranitroaniline (TNA) was patented by Dr. B. J. Flurschein, an English scientist.

bb. 1914. Lead styphnate (trinitroresorcinol), an initiating explosive, was first prepared by E. von Herz of Germany. Col. A. A. Solonina of Russia was the first to propose using lead styphnate in compound detonators.

cc. World War I. The high-explosive technology of the contending powers greatly influenced the conduct of World War I. At the outbreak of war in the summer of 1914, the German General Staff had planned to fight a high-explosives war of great intensity. Their plan was to mount a sudden and overwhelming attack using vast stores of artillery ammunition accumulated over the preceding forty years. After the battle of the Marne in 1914, the Germans realized that explosives production must be expanded; and they turned to their dye industry for this expansion. When the war began, Germany's chemical industry was producing 85% of the world's dyes. The Germans were able to rapidly convert their plants to production of synthetic ammonia, nitric acid, and sulfuric acid, which were required for the manufacture of explosives and chemical warfare agents. When Germany's access to Chilean saltpeter was cut off by the Allied blockade, the key to the German war production of explosives was the Haber process for producing ammonia from atmospheric nitrogen. By expanding their nitrogen plants at Oppau and Merseburg, Germany was able to become independent of foreign countries for the supply of ammonia and nitric acid. Because these chemicals were so essential for the manufacture of explosives and fertilizer for food products, it is doubtful if Germany could have continued the war beyond 1916 without the amazing speed with which the I. G. Farben concern was able to convert their dye plants to explosives plants. For example, at Leverkusen, a TNT plant producing 250 tons per month was put into operation in six weeks. The major powers began accelerating the search for substitutes or supplements to TNT. The most important were mixtures of high explosives, such as TNT, TNX, and TNN, with ammonium nitrate and aluminum. By 1914, the French had already begun

replacing picric acid (melanite) with TNT. In 1915, the British developed amatol (TNT plus ammonium nitrate) to extend the supply of TNT. In 1917, Austrian ammonal T (TNT, aluminum, and ammonium nitrate) was developed by R. Forg to be used in underwater explosives, such as torpedoes and depth charges. Lead azide was introduced as an initiator, and tetryl was used as a booster explosive for artillery shell charges. About 2,500,000 tons of high explosives were used by the contending powers during the war, resulting in an estimated 10 million casualties.

dd. *World War I.* High-explosive aerial bombs were first dropped from German Zeppelins during the 31 May 1915 raid on London. The Germans continued to use these dirigibles, practically unopposed, in their air raids on London and Paris until late in 1916. Then the British and French began to counter these attacks with anti-aircraft gunfire and fighter aircraft. Soon the Germans began using their large Gotha bombers, which they employed throughout 1917 and 1918. In retaliation, the Allies began producing fleets of larger bombers and various high-explosive bombs.

ee. *World War I.* Incendiary bombs were also first used during the German Zeppelin raid over London on 31 May 1915, when one dirigible dropped 90 incendiary bombs. The early incendiaries used by the Germans in their air raids over London and Paris were made from a mixture containing manganese dioxide and magnesium. Later, the French used sulfur-bound thermite, a mixture of iron oxide and powdered aluminum, in an incendiary drop bomb. The British were the first to develop incendiary bomb clusters, which could release either 144 or 272 bomblets. A De Havilland bomber could dispense up to 860 of these 6.5 oz incendiary bomblets, and a Handley-Page V bomber could dispense up to 16,000. By flying in formation, these bombers could cover a large area with a blanket of burning incendiary materials.

ff. *World War I.* Flamethrowers were first introduced by the Germans on the French front on 25 June 1915. Their weapon was a cylindrical steel vessel about 61 centimeters (2 feet) high and 38 centimeters (15 inches) in diameter, fitted with carrying straps. Internally, the cylinder was divided into a compression chamber and an air reservoir. A short hose carried the fuel to the nozzle where it was ignited. The propellant was nitrogen. The fiery spurt of burning oil, the roar of the flame, and the billowing clouds of black smoke had a terrifying effect on troops in trenches. Using this prototype of the modern portable flamethrower, the Germans drove back a British rifle brigade from trenches near Ypres, Belgium, in 1915. The Americans used a heavy viscous tar and a more fluid, flammable liquid such as crude benzene for their flame fuel

mixture. A hydrogen pilot lamp at the flamethrower nozzle was used to ignite the flame fuel. The World War I flamethrowers had a range of about 30 meters. Although effective for assaulting fortifications, the flamethrower was also very hazardous for the operator because of its short range.

gg. *World War I.* Smoke munitions were used both on land and sea by the belligerent powers in World War I. In July 1915, the British were the first to use smoke pots, which were filled with pitch, tallow, black powder, and potassium nitrate. The first large-scale smoke operation occurred on 20 September 1915, when the Canadians fired several thousand smoke shells from trench mortars during the attack against Messines Ridge. Although very successful against the Germans, the British and French tanks of World War I were capable of travelling only four miles per hour, which made them very vulnerable to artillery fire. The British Tank attack at Cambrai on 20 November 1917 was supported by intense artillery smoke shelling, which enabled 350 tanks to break through the German lines. On 15 June 1918, the Austrians used smoke to screen their crossing of the Piave River, from Vidor into San Giovanni, from Italian machine gun concentrations. The Allies generally used white phosphorus (WP) to fill their smoke shells; whereas the Germans, because of a shortage of phosphorus, used a mixture of sulfur trioxide in a chlorosulfonic acid solution. The Germans used this type of smoke (FS) to successfully screen their warships during the battle of Jutland in 1916. Later, the United States adopted FS smoke for use in spotting rounds, for liquid chemical agent shots, and in airplane smoke tanks. FS was reclassified obsolete in November 1975 because WP was considered better for marking targets and FS droplets from aerial spray destroyed the nylon fabric in parachutes. Titanium tetrachloride (FM) was also used as a filler for spotting rounds during both world wars, but was removed from the US inventory because of its high cost. In 1918, tanks carried containers filled with chemicals, which when injected into the vehicle exhaust system formed a cloud of screening smoke. Sulfuric acid, chlorosulfonic acid, oleum, and crude oil were used as the smoke screening agent in these early smoke generators. WP hand and rifle grenades were used by the infantry for screening movements. The main disadvantage was the danger of the user being exposed to falling particles of burning white phosphorus, which is also an incendiary. WP grenades were reclassified obsolete in November 1975 by the US Army.

hh. *World War I.* Incendiary artillery shells and rifle bullets were introduced in 1915 to set fire to buildings, supply dumps, and enemy observation balloons. The Germans used sodium in their 17.5 centimeter artillery shells. They also used thermite or an aluminum-thermite mixture in their other artillery rounds. The Allies used thermite most frequently. Thermite incendiary grenades were issued to raiding parties for hasty destruction of captured enemy weapons that could not be retrieved.

ii. *World War I.* Pyrotechnics for battlefield illumination were used extensively during World War I. The British alone used 10 million position light flares per month. The art of making illuminants had been neglected after the reign of Louis XIV until the twentieth century. In 1913, the German Krupp Works developed an illuminating projectile, which they called a searchlight shell and which later became known as the star shell. The first star shell contained six small tubes, called stars, loaded with an illuminating composition. The mixture used was similar to that in the white Bengal lights for fireworks displays; but ribbons of magnesium were substituted for antimony powder. A folded parachute was placed in the bottom of each tube. The projectile was fired from a cannon or mortar. When the projectile reached a height of 300 meters, a mechanical time fuze set off a small black powder charge releasing the tubes from the shell and igniting the pyrotechnic mixture. Springs were used to open the parachute instantly, and the tube with its burning star floated slowly to earth. The illuminating material burned very brightly for 45 seconds to several minutes depending upon the model. The French constructed a similar projectile containing eight cylinders, which was fired from their 155 millimeter howitzer. However, they preferred using burning-type fuses to set off the powder charge in their star shells. Later, the Germans replaced the star tubes with a six-sided prism, which was more compact and could be adapted for use with rifles, special pistols, and large caliber carbines. By using plates to retard the fall of the star, more space was made available in the star for storing the illuminating mixture; and a light of greater intensity or longer duration was obtained. The Italians used a hand-held, heavy pasteboard tube to discharge a sheet-iron star shell tube, which expelled its illuminating parachute flare. This flare burned about 40 seconds. Many different illuminating devices were developed and used by both sides, but perhaps the simplest and most useful for trench warfare was the illuminating grenade. Thus every soldier on night patrol had his own device for lighting his sector, and exposing the advancing enemy to aimed gunfire.

jj. *World War I.* During World War I, pyrotechnics for signaling included colored smoke cartridges, canTM 91300-214 dies, flares, streamers or trails, star signals,

and night signals. Four general designs of firework devices were in constant use by the French and the British armies. These devices were Very-type signal pistols, rifle lights, rockets, and ground or position signals (e.g. candles). (The same type of devices were used for illumination.) The signal-pistol cartridges used by the French were fitted with delay fuzes, which effected the ignition when the projectile reached its maximum height. Some realization of the development in pyrotechnic construction due to the war may be had by considering the latest production of the French 35-millimeter signal cartridge, which included 14 varieties or combinations of signals. Upon entering the war, the United States adopted many of the French signals for Army use. This was mainly because the American forces were to operate in the French sector, which necessitated an identical system of signals. Generally, the fireworks and devices employed by the Germans were similar to those of the French, but there was an important difference in the method of construction for the signal-pistol cartridge. The German cartridge was ignited just after emerging from the barrel of the pistol. Rockets mounted on sticks for stabilization during flight were employed by the Allies. The Germans followed Congreve's construction in the use of metal, but modified the design to eliminate the use of a stick. In the German rocket, the openings for escaping gas were in the base. Before the outbreak of the war, the art of pyrotechny had reached such a point that little difficulty was encountered in securing adequate mixtures for the various colors required in signaling. Different colored flares had been used for many years commercially. The railroad companies regularly employed pyrotechnic devices, such as red railroad fusee, while blue light pyrotechnics were used for signaling at sea. The colors used by the Allies included red, green, yellow, blue, black, various numbers of white stars, and changing colors. The Italians used a tri-color parachute flare, which emitted red, white, and green colors. The Italians also developed a hissing flare, which, when suspended from a parachute, burned with a hissing noise audible over an area of 3,000 meters (3,284 yards) in diameter. This was found particularly effective as a gas alarm. Some of the ingredients used in the WW I pyrotechnics were aluminum, potassium nitrate, sulfur, antimony sulfide, antimony metal, dextrine, meal powder, barium chlorate, potassium chlorate, fine charcoal, barium nitrate, red gum, paris green, shellac, sodium oxalate, magnesium carbonate, strontium carbonate, calomel, copper oxychloride, calcium carbonate, sawdust and grease mixture, sugar, lamp black, ultramarine blue, paranitraniline red, lactose, auramine, chrysoidin, synthetic indigo, phosphorus, paraffin, and arsenic.

2-8. Developments after World War I through World War II. The most complicated task confronting the US Army Ordnance Department at the end of World War I lay in the field of ammunition. Combat experience had shown the inadequacies of the ammunition used in 1917-1918, which were inaccuracies, failures, lack of safety features, and a host of needless complexities. But whereas the combat arms could specify exactly what the gun and vehicle requirements should be, their recommendations for the development of explosives, propellants, projectiles, and fuzes had to be couched in general terms. Here were basic research problems that ammunition experts had to define. Often they sought interim solutions, and waited until greater knowledge could supply better answers. Hence the ammunition designers had free reign within budgetary limits. Over the 20 years between the two world wars, the Army dedicated more money to the ammunition program than to any other development work. During these two decades, RDX, PETN, EDNA, DEGN, lead styphnate, and dextrinated lead azide were developed as military explosives. The development in the United States of processes for producing toluene from petroleum removed limitations on the availability of TNT, and permitted development of the powerful and castable explosives like composition B and pentolite. Flashless propellants were developed in the United States, and lowerosion DEGN propellants were developed in Germany and Italy. Diazodinitrophenol was developed as an initiator in the United States, and tetracene was developed in Germany as a new explosive ingredient of priming compositions. World War II (1939-1945) saw the development of rocket propellants based on nitrocellulose-nitroglycerin or nitrocellulose-DEGN mixtures, and the use of nitroguanidine in artillery propellants. New special-purpose binary explosives, such as tetrytol and picratol, were developed for use in demolitions, chemical bombs, and semi-armor-piercing bombs. A number of plastic explosives used for demolition work were developed in Great Britain and the United States, the most important being the C-3 composition based on RDX. The discovery and great value of the blast effect of explosives led to the development of tritonal, torpex, and minol, which contain powdered aluminum and have powerful blast effects. In the spring of 1943, EDNA or haleite was adopted for testing purposes after the DuPont Company, while under contract, overcame the problem of manufacturing ethylene urea, one of haleite's intermediates. But it was not until the end of the war that production of haleite could get started. Incendiaries were found to be even more effective than high-blast explosives in the destruction of cities. By using

improved fire bombs filled with thickened or gelatinized incendiary oil or gasoline mixtures, and large clusters of incendiary bomblets filled with thermate (an improvement of the WW I thermite), the US air forces were able to literally set fire to cities like Dresden and Tokyo. Flamethrowers and smoke munitions were used extensively by both sides. Finally, the extensive use of armor during the war led to the development of anti-tank weapons, armor-piercing shells, and shaped-charge munitions. The application of the shaped-charge principle resulted in the use of special explosives of the pentolite type.

a. *1918-1939.* Ammunition research in the first postwar years was inspired not only by new requirements, but also by the problems encountered in preserving ammunition, especially propellants, stored after the Armistice. Research proceeded in three areas: determining the stability of smokeless powder, studying the effects of long term storage on stability, and creating more efficient methods of drying. A good deal of valuable information on these substances was assembled at Picatinny Arsenal, NJ, before 1926, notably that on feasibility of the vapor method of drying, which reduced drying time from months or weeks to days. But a more permanent solution of some phases of the powder storage problem would be to develop new non-hygroscopic powders, which because of their chemical composition would not absorb enough moisture to affect their ballistics or chemical stability even when stored in a damp atmosphere. If, at the same time, flashless and smokeless qualities could be incorporated, the advantages would be even greater. Thus the search for flashless non-hygroscopic (FNH) powders was vigorously pushed. The DuPont Company, under a special agreement with the Ordnance Department, followed one route of investigation, while Picatinny Arsenal followed another. Each achieved considerable success. The peacetime development of complete single-base and double-base non-hygroscopic powders, flashless in many weapons, was one of the most useful accomplishments of the Ordnance Department before 1940. Traditionally, British propellants have been of the double-base type developed prior to World War II and designated as cordites. The cordites were made up of varying percentages of nitrocellulose, nitroglycerin, and mineral jelly. The mineral jelly (petroleum jelly or petrolatum) acted as a stabilizer. A sample of British MD cordite has been found to be of apparently unchanged stability after 30 years of temperature-climate storage.

The search for a compound that was both smokeless and flashless had its beginning in the requirement established by the US Army Ordnance's Westervelt Board in 1919. In the early 1920's, ordnance scientists offered the using arms samples of nitroguanidine, which to a degree unobtainable in any other known propellant, had both properties. But nitroguanidine gave off such noxious ammoniacal fumes in combustion that the Field Artillery vetoed its use. The Ordnance Department, with no customers in prospect, then abandoned all thought of building plants to make nitroguanidine. But ammunition specialists found no satisfactory substitutes. Adding potassium sulfate to propellants for anti-aircraft fire, where flashlessness was all important, helped to solve that problem. However, it was no answer to the demand for a completely smokeless and flashless propellant for field artillery where smoke would obscure a gunner's vision and muzzle flash would reveal the tank or battery position.

b. 1918-1939. Between the two world wars very little was done in the United States to develop the art of rocketry and rocket propellants. A golden opportunity to assume leadership in this field was missed when just before the Armistice in 1918, Dr. Robert H. Goddard, Professor of Physics at Clark University, demonstrated a shoulder-fired "recoilless gun" or "rocket gun" at Aberdeen Proving Ground, MD. The results of Dr. Goddard's demonstration were summarized by Ordnance Department witnesses as proving the validity of his concept of modern rocketry. However, the lack of suitable powder and the need for further work on the electrical firing mechanism along with the Armistice led the Ordnance Department to shelve the project. Goddard died without receiving any acclaim for this pioneering work, although comparison of his rocket gun with the bazooka adopted 24 years later shows how closely the 1918 model resembles the later weapon. During the 1920's, metriol trinitrate or trimethylolethane trinitrate, used as an ingredient in rocket propellants in World War II, was prepared in Italy and Germany. In 1931, the US Army created a one-man rocket unit by assigning Captain Leslie A. Skinner to study the possible use of rockets. Skinner was handicapped by limited funds for research, and by the indifference of superiors. During the mid-thirties, the British began more intensive research on anti-aircraft rockets in anticipation of massive bomber air raids upon their cities. In the meantime, the Germans made great strides in the development of rockets and missiles and

the attendant propellants. This was especially due to the work of Wernher von Braun in the late 1930's.

c. 1920. Cardox, a device for breaking coal in gaseous mines by the pressure produced on heating liquefied carbon dioxide, was developed. Similar devices were developed in the United States in 1930, and were improved upon in 1955 (Hydrox) and 1959 (Chemecol).

d. 1927. Diethyleneglycol dinitrate was thoroughly examined by W. H. Rinkenbach, and the current method of preparation was patented in 1928 by A. Hough.

e. 1930-1931. Dextrinated lead azide was adopted for use by the US Army, and began replacing mercuric fulminate in priming compositions.

f. 1931. 2,4-dinitrotoluene (2,4-DNT), obtained earlier as an impurity in crude TNT, was used in some explosive mixtures.

g. 1935. From the 1920's onward, scientists at Picatinny Arsenal had been trying to find a compound that would have the high brisance of RDX without the sensitivity to friction and impact. Research on this problem, principally by Dr. George C. Hale, chief chemist, led to the discovery of ethylenedinitramine (EDNA or haleite) the first entirely American high explosive. More powerful than TNT, EDNA was slightly less powerful than RDX but was also less sensitive. EDNA's stability gave it an important advantage in considerations of manufacturing, loading, storage, transportation, and field use. Designated haleite, in honor of Dr. Hale, this new explosive could be press-loaded into small shells without a desensitizing agent, and its derivative, ednatol, a mixture containing 42 percent TNT, could be melt-loaded into large shells as easily as amatol. These advantages were offset in prewar days by the high manufacturing cost of one of its intermediates, ethylene urea. Delay in solving manufacturing problems prevented haleite from getting into combat in World War II.

h. 1936. Primacord, based on a French patent, was developed by the Ensign-Bickford Company, CT. Primacord consisted of PETN covered with textiles, waterproofing material, and plastics. This detonating cord had a velocity of 6,405 meters (21,000 feet) per second, and has been used extensively by the armed forces for demolition work.

i. 1937. Baratol, a mixture of barium nitrate and TNT, was developed by the British and used extensively in WW II.

j. World War II. High Explosive Bombs. When World War II began in September 1939, the standard United States filler for high explosive bombs was trinitrotoluene (TNT). On 5 June 1940, the United States released 8,000 metric tons (9,000 short tons) of TNT to the British under Lend Lease. This came out of a manufacturing surplus of only about 9,000 metric tons (10,000 short tons). Most of the war was fought by the United States with bombs standardized in 1941. The earliest departure from TNT for the fillings was RDX, an explosive known for its great power and brisance but generally considered too sensitive. The British had developed a method of using beeswax to desensitize the RDX, and used this filler with terrible effect in the 2-ton "blockbuster" bombs dropped on Berlin in April 1941. During the following summer, Air Marshall Arthur Harris had pressed for large-scale production of RDX in America. The United States Navy was also interested in the explosive because of its effectiveness under water, especially in a mixture with TNT and aluminum called torpex. But the United States Ordnance Department, while willing to start production for the British and the Navy, held back until May 1943 on the use of RDX in its AAF (Army Air Force) bombs, and then adopted only a less sensitive mixture with TNT known as RDX Composition B. This first significant change in bomb-loading came about as a result of AAF insistence that the large fragmentation bombs developed in 1943 would need the greater power of RDX Composition B to burst their thick walls with the greatest effect. Henceforth, Composition B was used in only about 40 percent of the general purpose bombs. The reasons were twofold. First, the short supply caused by competition between RDX, and high octane gasoline, and synthetic rubber for production facilities and, second, the tendency of Composition B to detonate high-order without fuze action under the shock of impact. RDX was more prone than TNT to prematurely deflagrate (decompose rapidly without detonating) when employed in delayed-action bombs dropped from high altitudes. In the war-long argument over the relative merits of blast and fragmentation, the pendulum now began to swing back toward blast partly because by 1944 the AAF would have aircraft capable of delivering larger and heavier loads. After 1943, the new aluminized fillings were of far greater interest than either RDX Composition B or ednatol. Until WW II, the use of aluminum in explosives had not been extensive. Tests in 1941 in England had failed to indicate any significant difference between aluminized explosives and amatol or Composition B. In

1943, the discovery that German bombs containing aluminum were extremely effective spurred research. This led to the development of minol, a mixture of aluminum with amatol, and tritonal, a mixture of aluminum with TNT. For their 2-ton blockbuster bomb, the British favored Minol 2, a mixture of 200/o aluminum, 400/o TNT, and 400/o ammonium nitrate; and they requested that Minol 2 be used in their blockbuster bombs being loaded in the US. The British, by using new methods of blast measurement and interpretation, had learned that Minol 2 produced an area of demolition approximately 30 percent greater than the area obtained with a TNT filler. US Army Ordnance technicians had independently arrived at a similarly high opinion of the blast effect contributed by aluminum. They arrived at this conclusion by comparing the performance of one and two-ton blockbuster bombs loaded with minol, TNT, ednatol, and the RDX mixtures. In comparing minol and tritonal, they preferred tritonal, because it contained no ammonium nitrate. When even the slightest degree of moisture was present in the air, aluminum acted on ammonium nitrate and produced "spewing" (the evolution of hydrogen gas) and explosions. Tritonal was much safer, and the British were won over to it. The AAF adopted tritonal for large, light-case bombs for jungle warfare, and for all general purpose bombs. Other bombs were filled with explosives suitable to their particular purposes. For fragmentation bombs, RDX Composition B continued to be the preferred filling because it had more brisance than tritonal. The US one-ton semi-armor-piercing bombs developed in early 1944 were loaded with picratol, a mixture of TNT and ammonium picrate, or with Explosive D. Explosive D was the least sensitive to shock and friction, which made it the best explosive to mix with TNT in a bomb that had to withstand severe shock and stress before detonating.

k. World War II. Reverse Nitration of TNT. During 1941 and 1942 the inadequate supply of TNT for high explosive bombs and shells was a major problem for Ordnance. Because the shortage had been foreseen, plans were made to use a substitute explosive called amatol (a mixture of TNT and ammonium nitrate) for shell or bomb loading until new TNT plants came into full production. Even so, a critical shortage of TNT developed despite these plans. But the shortage suddenly disappeared when a new process appeared on the scene almost by accident. During an inspection of a small Canadian TNT plant at Beloeil near Montreal in 1941, LTC John P. Harris of Ordnance discovered that

the plant was "doing things backward" by putting toluene into the acid instead of putting acid into the toluene. Despite some resistance by US TNT producers, the new process was tried at the partly built Keystone Plant at Meadville, PA. The result was a tripling of TNT output. Lines designed to turn out 16 tons a day produced more than 50 tons a day. The need for TNT substitutes vanished, and the cost per unit was cut in half.

l. *World War II. Toluene from Petroleum.* Development of a new means of producing toluene, the basic material from which TNT is made, was another highly significant technological advance of World War II. The importance of this chemical stems from the fact that nearly half of every unit of TNT (trinitrotoluene) must come from toluene. In World War I, toluene was derived from coal as a by-product of coke ovens, and some was extracted from natural gas. Yet the supply in 1917-18 was so limited that the Assistant Secretary of War, Benedict Crowell, later called this shortage "the greatest and most pressing of all the problems in regard to existing raw materials." In contrast, during World War II high-explosives production was never seriously hampered by lack of toluene. As early as 1927, Standard Oil of New Jersey had obtained patent rights from a German firm to use a process for producing toluene from petroleum. In 1939, a contract with Standard Oil was placed by Picatinny Arsenal to prepare toluene by this process at Baytown Ordnance Works, which was erected next to the Humble (a Standard Oil subsidiary) refinery in Baytown, TX. By October 1942 this plant was producing toluene at the rate of 246 million liters (65 million gallons) per year, which when compared with a total toluene production of less than 34 million liters (9 million gallons) in the US during 1918 shows us the value of this process.

m. *World War II. Artillery Propellants.* The problem of obtaining artillery propellants that were both flashless and smokeless continued to plague the U.S. Army. Early in the war, the Navy seized upon nitroguanidine as the one feasible answer to novel conditions of combat. For the first time, American ships in the Pacific were preparing to fight in small harbors where maneuvering was all but impossible. Flash at night betrayed the vessel's position, and smoke by day made second rounds inaccurate. Negotiations with Canada in 1943 for the purchase of nitroguanidine, from the one plant upon which British and Canadian forces were also depending, succeeded in meeting Navy needs but left no surplus for the US Army. The Army Ground Forces were not convinced of the value of this propellant until TM 9-1300-214 shortly before D-Day.

By then, urgent demand could not allocate facilities to produce nitroguanidine in large quantities, and the Ordnance Department could only procure small lots for testing and experimental firing. Whatever the advantages of nitroguanidine, neither it nor any other composition was ideal for all purposes. Even in conventional artillery and small arms ammunition, where ballisticians understood propellant behavior better than in rockets and recoilless rifle ammunition, compromises were inescapable. The primary requisite for one weapon or one particular use tended to be different from every other weapon or use. In addition to these problems, World War II introduced the problem of climate extremes at which firing had to take place when Allied troops were fighting in arid deserts, damp jungle heat, or in the subzero winter weather of northern Europe and of the Aleutian Islands. Therefore, a series of propellants were needed to cover widely varying contingencies. Since basic research as well as prolonged applied research was necessary, many problems remained unsolved at the end of the war. But the field was explored more thoroughly than ever before in the United States, and lines of investigation were clarified for postwar development. In processing propellants, industry and the Ordnance Department made considerable advances during the course of the war. One new method developed by the Hercules Powder Company for washing nitrocellulose in a continuous filter instead of in large tubs by the old "settle and decant" system, washed the nitrocellulose more thoroughly and thus improved the stability of nitrocellulose. The DuPont Company found that using preheated alcohol during the winter to dehydrate nitrocellulose reduced the hydration time cycle, improved the yield, and made for a more uniform product. This in turn produced a much better powder. The Radford Ordnance Works carried on extensive experiments to improve manufacturing and testing techniques as well as for finding better chemical compositions. Yet in the spring of 1945, reports from the Combined Intelligence Objectives Subcommittee, established to locate data in Europe on Axis research and manufacturing procedures, indicated that Germany had developed several processes more effective than those of the United States. The most novel German method was one of casting propellant grains by adding a paste of moist nitrocellulose and diethyleneglycol dinitrate (DEGN) to molten TNT and pouring the mixture into steel molds to cool. Grains as large as 1,000 millimeters were cast this way. After the war, complete sets of the German equipment deemed most useful and novel went to Picatinny Arsenal for study.

n. *World War II. Wood Pulp and Cotton Linters.* Before the war, the standard practice for making smokeless powder called for the treatment of bleached cotton linters with a mixture of nitric and sulfuric acid. In the summer of 1941, it became apparent that even with a good cotton linters crop and capacity operation of bleacheries, the supply of linters for powder would fall short of requirements. Ordnance chemists, therefore, turned to the use of a special wood pulp that was available in quantity, was suitable for most kinds of powder, and was cheaper than cotton linters. The Hercules Powder Company had made smokeless powder from wood pulp for a number of years, and Ordnance found the product completely acceptable. Use of wood pulp as a supplement of, but not a replacement for, cotton linters was approved promptly except for rifle powder and certain other uses. Soon most plants had one or two lines for nitrating cotton, an equal number of lines for nitrating wood pulp, and several "swing lines", which were adaptable for use of either materials. From January 1942 to the end of the war, Ordnance plants used roughly equal quantities of cotton linters and wood pulp. There was never a concurrent shortage of both materials, although there were times when the supply of one ran low or was expected to run low. At such times, Ordnance drew upon its inventories while converting the swing lines to meet the situation. The use of wood pulp doubled the existing supply of cellulose for powder, and eliminated a serious potential bottleneck in ammunition production.

o. *World War II. Rocket Propellants.* Difficult though the US program was for improving propellants for conventional weapons, the question of developing suitable rocket propulsion was still harder to answer. From the very beginning everyone concerned with rocket research agreed that single-base powders would lack the necessary energy and that double-base powders, that is nitrocellulose and nitroglycerin combined, must be used. Double-base powders, made by the solvent process, had been manufactured in the United States for a number of years for use in intermediate and large caliber artillery. The method used a solvent of acetone and alcohol to make a colloid, from which grains or flakes could then be formed. About 1939, the Hercules Powder Company found a way of producing a solventless double-base propellant, which was plasticized by heat and pressure and then rolled out into sheets for mortar increments. But neither was adaptable for rockets where a solid stick or grain, not sheet propellant, was needed, and where the essential quality of uniform burning precluded using a grain without so much as a hair crack or fissure. Even a

tiny crack in a burning grain of powder would create pressure peaks at particular spots of the encasing rocket mortar tube and thus either burst the tube or cause erratic propulsion. Consequently, to get a safe usable rocket propellant made by the solvent process meant using grains of small cross-section (in technical phraseology, thinwebbed powder) in which malformations occurring in drying would be few and inspection could be exacting. A method of manufacturing solventless double-base propellant by a dry extrusion process had been developed in the late 1930's by the British. This produced much thicker-webbed, and therefore longerburning, grains, but required enormously heavy presses to extrude or compact, and force out the propellant into the desired shape.

p. *World War II High Explosive Artillery Projectiles.* Considerable power combined with sensitivity, which made for easy loading, stability, and safety in handling and transport, made TNT and amatol the preferred highexplosive fillings for most high-explosive artillery shells at the outset of World War II. This was largely due to their availability in large quantities. As the war progressed and ammunition became more complex in design and more specialized in function, demand arose for improved explosives. This demand could not be met to any extent because the explosives developed between wars did not get into large-scale production in time. Nevertheless, throughout the war the US Army Ordnance Department sought ways of using more powerful new explosives, and ways to adapt old ones to special purposes. There were at hand several explosives of higher shattering effect, or brisance, than TNT. The most important were, first, cyclotrimethylene trinitramine, which the Americans called cyclonite and the British called RDX ("Research Department Explosive"); second, pentaerythritol tetranitrate or PETN; and third, EDNA (later called haleite). RDX and PETN were too sensitive to be used in the pure state in a shell. Therefore, to form usable compositions it was necessary to combine them with oils or waxes or with other explosives. The British had managed to desensitize RDX by adding nine percent beeswax to form Composition A for press-loading into shells; with 39.5 percent TNT and one percent beeswax to form Composition B, chiefly for bomb loading; and with 11.7 percent of a plasticizing oil to form Composition C, for demolition work. These formulas were provided by the British to the US in 1940, and development work was undertaken by the DuPont Company under contract of the Ordnance Department.

The most sensitive of all high explosives was PETN, which was even more readily detonated than RDX. PETN was desensitized by mixing with TNT to form a composition named pentolite, which has been extensively used in detonators, bazooka rockets, rifle grenades, boosting devices, and in the shaped charges of antitank shells. Because of production difficulties, haleite, the most promising of the new high explosives, never saw much use in World War II except in the form of ednatol in mixtures with other explosives.

q. World War II Armor-Piercing and Antitank Projectiles. Much of the work of improving high-explosive compositions was directed toward finding the most efficient filling for anti-tank shells. For armor-piercing projectiles, relatively insensitive ammonium picrate, "Explosive D," had long been preferred. As it was not likely to detonate on impact, the shell could penetrate the armor plate before exploding. But experience with heavy German tanks in North Africa showed that something more was needed in the way of power and fragment action coupled with greater incendiary effect within the tank. Chemists at Picatinny Arsenal accordingly tried several expedients. In armor-piercing shell, addition of a small amount of powdered aluminum to cyclotol (a mixture of RDX and TNT), to ednatol, or to TNT produced more brisance than Explosive D and increased sensitivity to impact. In high-explosive antitank shell fillings, conversely, the difficulty was the exact opposite. The high sensitivity of pentolite made it liable to detonation on target impact so that the problem was to desensitize it to the proper degree. Several possibilities considered were the addition of wax to the pentolite, the reduction of the PETN content, and the substitution of ednatol or Composition B. None was entirely satisfactory. The search for an explosive composition of the greatest possible power and brisance took a new turn after analysis of foreign explosives at Picatinny Arsenal during 1943. Hitherto, research had been concentrated on binary explosive compositions such as pentolite, Composition B, or ednatol. The examination of a Soviet 76mm high-explosive armorpiercing round suggested the possibility of employing ternary mixtures. Tests revealed that castable ternary explosive mixtures, such as RDX-Tetryl-TNT and Haleite-PETN-RDX, offered promise not only for armor-piercing projectiles but as fragmentation ammunition for weapons designed to produce blast, and for demolition charges. Further study showed that haleite ternaries were unstable. The best combination seemed to be a mixture of PETN-RDX-TNT designated PTX-2 (Picatinny Ternary Explosive). More brisant than any of TM 9-1300-214

the binary compositions, PTX-2 was more stable than 50/50 pentolite and less sensitive to impact. Preliminary firings at Picatinny indicated that PTX-2 would be particularly adaptable to shaped-charged ammunition; but PTX-2 was still in the testing stage at V-J Day.

r. World War II. Shaped Charges. If no new explosive for artillery shell came into use during the war, a new way of employing explosives nevertheless did. The effect of a hollow-charge or shaped-charge projectile against armored targets was first successfully demonstrated by the bazooka and the rifle grenade. The intense forward jet of the charge, serving to focus part of the energy of the explosion in a limited area, gave to the light-weight, low-velocity rocket the armor-piercing advantages hitherto possessed only by high-velocity artillery. The antitank rifle grenade, containing only 113 grams (4 oz) of pentolite, would penetrate up to 102mm (4 inches) of homogeneous armor plate at a normal angle of impact. The first rifle grenade to use this principle was designed by a Swiss inventor, Henri Mohaupt, whose claims of inventing a "new explosive" had interested the British in 1939. However, the price Mohaupt quoted for his discovery was considered too high and the British showed no further interest in his invention. Mohaupt then offered to show the United States particulars of the construction of his device for a fee of \$25,000 paid in advance. Caution on the American part further delayed acquiring the rights until a demonstration by Mohaupt at Aberdeen Proving Ground, MD, was permitted in 1940, doubtlessly because Mohaupt provided 200 grenades for the demonstration. Army and Navy representatives who witnessed the test firings were convinced that this was indeed an important "new form of weapon." A similar proposal by Nevil M. Hopkins, an American inventor, for a shaped-charge bomb had been rejected earlier by the United States Ordnance Department as not being a new concept. By citing a 1911 British patent by Egon Neuman of the "Munroe-Neuman" principle, the Ordnance Patent Section thereupon showed Mohaupt's "secret" to be no secret. Thus the Ordnance was able to conclude a more reasonable contract with Mohaupt's company than the Swiss had originally demanded. An adaption of Mohaupt's design later formed the basis for the M9A1 antitank rifle grenade, and the 2.6-inch antitank "bazooka" rocket. Application of the shaped-charge principle to artillery naturally proceeded. The choice of howitzers was logical because their low velocity made conventional types of armor-piercing projectiles ineffective, whereas for a shaped-charge explosive low velocity was an advantage. Before Pearl Harbor, in an

atmosphere of great secrecy, work began on a shaped-charge shell, specifically the "HEAT" (high explosive antitank) round, for the 76mm howitzer. The designers, paying careful attention to the length of the ogive, the filler of 50/50 pentolite, and the striking velocity, came up with a round of the same length as the corresponding high-explosive round. The HEAT round, at a muzzle velocity of approximately 305 meters per second, would penetrate 76 millimeters (3 inches) of homogenous armor plate. A similar shell for the 105 millimeter howitzer appeared simultaneously. Standardized in late 1941, HEAT shells were produced in time to take part in the North African tank battles early in 1943. The Ordnance Department had high hopes that the HEAT rounds would succeed in penetrating the heavy German armor plate that had defeated solid armor-piercing ammunition. Although sometimes successful, the performance of shaped charges was not dependable enough. In an effort to find out why, the Ordnance Department, with the help of the National Defense Research Committee (NDRC) and the Navy, intensified its research. In some cases, observers in the field had blamed faulty manufacture, but investigators proceeded on the assumption that design of the round and the principle of operation needed improvement. Because of the difference in behavior of the nonrotating rocket and the rotated shell, the effect of the spin was carefully studied as well as the method of fuzing. One of the most important discoveries was that an increase in plate penetration was directly proportional to an increase, up to approximately three calibers, in "standoff" distance, that is, the distance from the base of the cone to the target at the moment of detonation. Yet this finding was only a beginning, and the solution to the puzzling behavior of hollow charge projectiles was not found during World War II.

s. *World War II Smoke Screening Munitions.* In the spring of 1940, the Germans demonstrated the value of smoke to screen their advance when they blitzed the Low Countries. Basic developments in smoke employment during World War II were its use to screen river crossings, beach landings, paratrooper assaults, and rear area targets from artillery fire and aircraft observation and attacks. Prewar versions of the HC smoke pots were enlarged, and floating smoke pots were developed for amphibious operations. Aircraft smoke tanks were developed for spraying liquid smoke mixtures. Smoke generators were developed for screening large areas by vaporizing fog oil. White phosphorous (WP) was the choice filler for most

projectiles, but also had the undesirable disadvantage of sometimes becoming an incendiary. Another disadvantage was that WP tended to melt in hot climates, which affected the stability of the round in flight. Storage in hot climates also resulted in expansion of the WP and subsequent leakage. Despite these shortcomings, WP was very effective for building up smoke screens as particularly demonstrated by the 4.2-inch mortar battalions in Europe and the Pacific. Smoke bombs filled with WP and PWP were used extensively for spotting targets and for screening parachute drops. Plasticized WP or PWP was developed to reduce the pillaring effect of the exploding munition found with pure WP. PWP is obtained by mixing WP with a very viscous solution of synthetic rubber to form a homogenous mass. For loading into munitions where a longer lasting smoke screen is desired, HC (hexachloroethane mixture) was preferred, e.g., smoke pots and base ejection shells. WP was used in rifle grenades. HC was used in hand grenades. US tanks in North Africa were outfitted with smoke grenade launchers to screen the tanks from antitank fire.

t. *World War II. Pyrotechnics for Illumination.* In 1944, the Army Air Forces (AAF) made an important change in doctrine that affected munition development requirements when they initiated 24-hour bombing operations. Night bombing, always favored by the Royal Air Force but hitherto opposed by the United States, gave new importance to pyrotechnics. Aircraft flares came close to the usual bomb design. The AN-M26 aircraft parachute flare, designed to provide illumination for night bombardment, contained its illuminant mixture in a round-nosed, finned-tail cylinder and developed 800,000 candlepower for about three minutes. The most important development concerned high-altitude night photography, and markers to identify targets at night. The prewar M46 photoflash bomb gave only 500 million candlepower. Picatinny Arsenal experimented with different combinations of case, filler, and initiating system. The result was a photoflash bomb that produced approximately three times as much light as the M46. Target identification bombs grew out of a technique evolved by the British to improve the accuracy of their night bombing. Their "Pathfinder Force" equipped with special navigational aids flew over a target in advance of the attacking force and dropped various kinds of candies and flares, some to illuminate the general area and others to mark the special target with color. One munition designed specifically for

this work was a stabilized bomb that ejected sixty-one pyrotechnic candles at a predetermined altitude. In the United States, the earliest research on target identification markers produced five bombs of this type. All were modifications of the 250-lb general purpose bomb and differed one from the other in the type of candle they contained. The candles were small flares that burned with either red, green, or yellow light for about three minutes. Each target identification bomb released its load of these signal candles, which together made a pattern of colored light approximately 100 meters in diameter around or on the target. These signal candles were designed to be visible from altitudes as high as 35,000 feet. To keep the candles from being disturbed while they were on the ground, one type of candle had an explosive charge that would detonate at the end of the burning time of the candle, the time being from one to two minutes. As the AAF extended its night operations, especially low-level bombing and strafing of illuminated targets by fighters and light attack bombers, need arose for ground burning flares that would produce a minimum amount of smoke and thus leave the targets as clear as possible. For this purpose, the Ordnance Department developed flare bombs loaded with smokeless units. At the end of the war Army and Navy experts agreed that future developments must be aimed at greatly increasing the candlepower, burning time, and visibility of all pyrotechnics, especially the photoflash bomb.

u. *World War II. Pyrotechnics for Signaling.* With the use of massive bombing air raids and close ground support by the Army Air Forces came the need for better signaling devices. Especially important were hand signals for downed fliers. Survival kits were developed which included colored smoke and flare distress signals for the aviators to carry. A substantial improvement in the ground signals used by the Armed Forces was made when the US Army Chemical Warfare Service (CWS), now the Chemical Corps, made a change in the method of consolidating the colored smoke mixtures in the grenades used for this purpose. The prewar M1 colored smoke grenades used a slow-burning mixture that burned about two minutes. In 1942, the Army Ground Forces established a requirement for a colored smoke grenade that would form a smoke visible at a slant range of 3,050 meters (10,000 feet) and last about one minute. By devising a method of consolidating the pyrotechnic smoke mixture with heavy presses, CWS engineers were able to provide a grenade meeting the Army TM 9-1300-214 Ground Forces' requirements.

After limited testing, the new grenade was type classified as the M18 smoke grenade and was issued in four colors: green, red, violet, and yellow. The M18 grenade remains the most widely used signaling device for ground troops today, which is a remarkable achievement considering that the M18 was adopted for Army use within six weeks of the statement of the requirement. This same loading technique was later applied to artillery base ejection canisters for marking boundaries.

v. *World War II. Flame and Incendiary Munitions.* In the intervening years from World War I to World War II, the development of flame weapons was studied by most nations except the United States. During the Ethiopian War in 1935 and 1936, the Italians employed the first armored vehicle-mounted flamethrowers. The Germans employed a flame tank during the Spanish Civil War and in 1939 used portable flamethrowers in Poland. These instances proved to the United States that the development of flame weapons could no longer be denied. In 1940, the US Army took steps toward developing a flamethrower and a flamethrower tank. These flamethrowers served an important role in the war in the Pacific, particularly in dislodging the determined Japanese soldiers from caves and fortifications. On Okinawa alone, flamethrowers are credited with the capture or death of 20,000 Japanese soldiers who were holed up in the caves while less than 100 American flamethrower operators were killed in the operations. The development of napalm ("nap" for the naphthenic acids and "palm" for the coconut fatty acids which made up the first type of this thickener) by the United States in 1941 made possible the greater use of gasoline for use in flame weapons. This gelled mixture made it possible for aircraft to deliver fire bombs over hard-to-get pinpointed areas and for flamethrowers to project a flame rod over a greater distance than was previously obtainable. By August 1944 the United States AAF Board had come to the conclusion that "where there is vulnerability to fire, the damage by fire is greater than by demolition," a conclusion, to be sure, that observers had reached during the London blitz of 1940 but which had not been acted upon. The decision of the Board in 1944 was to increase the incendiary bomb program to the highest priority. The United States Army CWS provided the Army Air Force with about 48 million incendiary bombs, which were effectively used, especially on the large cities of Japan. Most of these bombs were clustered bomblets containing thermate (TH3 and TH4), a new

incendiary mixture, which replaced the original thermite mixture. When ignited, thermate burns intensely at 2,200°C. Molten iron from burning thermate will melt metal, burn through steel plate, and ignite flammable materials. Oil and metal incendiary mixtures, such as PT1 and PTV, were also used as fillings in large thin-cased bombs. PT1 is a complex mixture based on "goop," a paste comprised of magnesium dust, magnesium oxide, and carbon, with a sufficient amount of petroleum distillate and asphalt to form the paste. PTV is an improved oil and metal incendiary mixture of polybutadiene, gasoline, magnesium, sodium nitrate, and p-aminophenol. However, napalm proved to be one of the most effective aerial incendiary agents in the war. On the evening of 9 March 1945, more than 300 Superforts (B29 bombers) swarmed over Tokyo dropping about 2,000 tons of incendiaries, mostly clusters of M69 six-pound bomblets. The M69 bomblet was a tube which contained a black powder propellant charge that ignited and projected the napalm filling from the tube. Aerial photos indicated 16 square miles had been burned out. Tokyo police records, examined after the war, showed that more than 250,000 buildings were destroyed about one fourth of Tokyo in this one raid. More than 100,000 tons of incendiaries were dropped on the cities of Japan during World War II. Most of these were M69 bomb clusters. For destroying materiel to prevent enemy use, the CWS developed a thermate grenade, which was standardized as the AN-M14 TH3 incendiary grenade for use by the Army and Navy. Harvard University also developed a napalm fire starter (MI), for use by troops to ignite fires in wet climates. The armament of the American heavy bombers was usually the .50 caliber machine gun. During World War II, enemy fighter aircraft did not have armor plating capable of deflecting a .50 caliber bullet, although, bullet penetration of the plane's armor did not necessarily knock out aircraft. The enemy's use of self-sealing fuel tanks necessitated the development of effective incendiary ammunition. Most urgently needed was an effective .50 caliber incendiary round. The first acceptable design was the work of the Remington Arms Company whose staff already had considerable experience in working on Swiss patents for incendiary ammunition. The Remington development was based upon the British .303 B Mark VI Z, and was adopted in September 1941. The bullet was a flatbase type with lead base closure and steel body, and was charged with 35 grains of a incendiary mixture consisting of 50 magnesium alloy and 50 percent barium nitrate. An improved design was developed shortly thereafter by

Frankford Arsenal and was standardized for United States use.

2-9. Post-World War II Developments. The nuclear bombs that ended World War II did not end requirements for conventional explosives and ammunition. As was shown by the Korean War (1950-1953) and the Vietnam War (1964-1973), the need for the United States to develop even more effective munitions and more powerful explosives or energetic materials became more apparent than ever. In spite of intensive effort, chemists at the Army's laboratories and arsenals failed during World War II to develop a new explosive composition for shell loading that was both satisfactory and readily available in quantity. The obstacles were often disheartening. The characteristics of an explosive might be considerably affected by impurities that existed in the raw material or which were admitted during manufacture. For example, the instability of PETN was probably due to impurities in the raw material, pentaerythritol. Other variables that had to be taken into account were the different methods of testing compositions and the differences in interpreting results. Assuming a composition had been found that promised to combine greater brisance with less sensitivity, there was still the question of whether it could be economically manufactured, safely handled, and made unchanging in character in temperatures ranging from arctic cold to tropical heat. In the search for explosives with special properties, much work had been done in the field of aluminized explosives, but, although aluminized TNT (triton) was used in bombs, much remained to be done. At the end of the war the Ordnance Department felt that deeper study of the fundamental properties of all high explosives was essential to effective developments in the future. Some of the problems of finding suitable high explosives and propellants have been resolved in the decades following World War II. Other problems have cropped up as the expanding techniques of modern warfare lead to more and more specialized requirements for explosives and propellants. Future developments may be expected to take the direction chiefly of mixtures of currently known explosives and other materials. But in some cases, the requirements can be satisfied only by new and more powerful explosives which are presently being sought. As seen by the experience of the two world wars, scientists engaged in the field of energetic materials must keep abreast of foreign technology and be prepared to exploit technical intelligence. The everchanging and rapid advance of

technology makes it necessary to shorten the lead time from research and development to deployment of new ammunition and explosives. But research and development is only the tip of the iceberg; the biggest expenditures for materiel in the Army go to the procurement and management of ammunition. An Army cannot fight for long without the right kinds of ammunition being available in the necessary mix and quantities needed to perform its mission. A responsive, flexible, viable production base and balanced inventories must be maintained to assure a strong readiness posture. With continuing budget restraints, all those in the armaments research and development community must consider these restrictions and exercise close control of the limited resources allocated to them for this purpose. Therefore, scientists and technicians working in this field must direct their priorities for research and development to those projects with the best prospects of being beneficial to armed forces materiel readiness, and avoid projects that may have only marginal applications to wars of the future.

a. *1945.* PLX (Picatinny Liquid Explosive), consisting of 95 percent nitromethane and five percent ethylenedinitramine, was developed at Picatinny Arsenal by L. H. Eriksen and J. W. Rowan for use in mine clearing. The Germans had used similar liquid explosives during World War II under the name Myrol.

b. *1945.* Tripentaerythritol octanitrate was patented by J. A. Wyler of Trojan Powder Company, PA, for use as a high explosive and possible gelatinizer for nitrocellulose.

c. *1946-1949.* Composition C-4, known as Harrisite, was developed by K. G. Ottoson at Picatinny Arsenal as a replacement for Composition C1, C-2, and C-3. Composition C-1, C-2, and C-3 were the United States standard plastic RDX demolition explosives, and were originally derived from Britain's Composition C, which was developed during World War II.

d. *1946-1949.* Benite, a black powder substitute, was developed at Picatinny Arsenal for use in igniter compositions of artillery primers, or in base igniter bags for separate-loading ammunition. Benite is in the form of extruded strands consisting of ingredients of black powder in a matrix of nitrocellulose.

e. *1946-1949.* Composition D-2, which is not an explosive but serves as an emulsifier and

desensitizer of explosives like HBX-1, was developed. Composition D-2 consists of 84 percent wax, two percent lecithin, and 14 percent nitrocellulose.

f. *1950-1953.* When World War II ended, the United States had a tremendous inventory of ammunition on hand, but unfortunately it was not a balanced stock. There were enormous quantities of some types of ammunition, and only small amounts of others. The hasty mobilization of manpower for the Korean conflict stripped the Ordnance Department of the military and civilian personnel that might have properly assessed and cared for the huge inventories of ammunition in its custody. During the years preceding the Korean War, powder packed in cotton bags and fuzes made of substitute metals deteriorated. The Army drew too freely upon the large ammunition stockpile for training purposes, yet made no real effort to replace consumption or balance the items in stock. The lack of postwar orders sent the ammunition industry into an eclipse. When the United States entered the Korean struggle so suddenly in 1950, ammunition facilities and plants were at a low ebb, and businessmen were reluctant to reconvert their factories to wartime effort. Another element that restrained a shift to the immediate production of ammunition was the prevalent belief that the Korean War would be short, and did not warrant a sizeable dislocation of the United States industrial effort. Even after this fallacy was shattered by the entry of the Chinese into the war in late 1950, the policy of butter and guns continued, and no large scale mobilization of industry took place. Compounding the situation of unbalanced stocks, the lack of industrial mobilization that normally follows the outbreak of war led to further setbacks in the battle for ammunition production. By the time funds budgeted in 1951 were translated to production in 1953, the war was practically over. In the meantime, the answer to the shortages in Korea was for the Army to reduce the authorized ammunition required supply rates in the belief that the combat units were wasting their ammunition. The net result was a war in which American firepower could not be used to its best advantage. The lesson learned from this is that a need for better industrial mobilization planning, and for closer contact with industry in the development and maintenance of a viable production base exists.

g. 1950-1973. During the Korean conflict, both portable and mechanized flamethrowers were used and found to be very effective. Flame mines, using incendiary bursters to set off 55-gallon drums of napalm, were used in a defensive role. The large batches of napalm required for these operations were mixed in truckmounted service units. M1 fuel thickening compound was used to gel the gasoline for flamethrowers and landmines. An undesirable feature of M1 thickener is that it absorbed moisture rapidly from the air, which degraded the gelling properties so that the gel became unstable. Army chemists at Edgewood Arsenal, MD, began work on a nonhygroscopic thickener, which was standardized later as M4 flame fuel thickening compound. The M4 flame fuel thickening compound is a di-acid aluminum soap of isooctanoic acids derived from isooctyl alcohol or isooctyl aldehyde, which are obtained from the oxidization of petroleum. Because of the large World War II surplus inventory of M1 thickener, M4 thickener was not produced in quantity until the Vietnam War. The Air Force used tremendous quantities of fire bombs. These bombs were essentially large fuel tanks filled with napalm, which were ignited by pyrophoric igniters (WP or sodium) upon impact. Continuous process mechanical mixers were developed for use at Air Force bases to mix and fill the fire bombs on the spot. M1 thickener could be mixed only in batches, so a new thickener, M2, was developed and fielded. M2 flame fuel thickening compound is an intimate mixture of 95 percent M1 thickener and five percent devolatilized silica aerogel or other approved antiagglomerant. M2 thickener was an improvement of the M1 thickener for use in fire bombs. This is because of the free-flowing and fast-setting characteristics, which allow its use in continuous mechanical mixers. M2 thickener was not suitable for use in flamethrowers, which require an aged gel obtained in the batch process. Napalm B, a special fire bomb fuel formulation, was developed by the Air Force to replace M2 thickener. Napalm B currently consists of 46 percent polystyrene, 21 percent benzene, and 33 percent gasoline by weight. Napalm B withstands high velocity impact dissemination more effectively than M2 thickened gasoline gels, resulting in less fuel burned enroute and more fuel delivered on target.

h. 1950. MOX (metal oxidizer explosives) were developed by National Northern Technical Division of the National Fireworks Ordnance Corporation, West Hanover, Mass, for use mostly in small caliber anti-aircraft shells.

i. 1952. Military medium velocity dynamite was developed by W. R. Baldwin, Jr. at Hercules Powder Company Laboratory.

j. 1952. PB-RDX (plastic-bonded RDX) was developed by the Los Alamos Scientific Laboratory of the University of California for use as a mechanical strength explosive. PB-RDX consisted of 90 percent RDX, 8.5 percent polystyrene, and 1.5 percent dioctylphthalate.

k. 1957. Military low velocity dynamite was developed at Picatinny Arsenal by H. W. Voigt.

l. 1958. HTA-3 (high temperature explosive) consisting of 49 percent RDX, 29 percent TNT, and 22 percent aluminum was prepared at Picatinny Arsenal.

m. 1958. Octols 70/30 and 75/25, mixtures of HMX and TNT, were developed at Northern Corporation as fillers for bombs and shells. Octols are standard high explosive fillers, which have been adopted for Army use.

n. 1958. Slurry explosives were developed by M. A. Cook and H. E. Farnham by adding water to ammonium nitrate to form slurries of the oxidizer salt, ammonium nitrate and sodium nitrate, and a solid fuel sensitizer. Slurry explosives provide three to six times the detonation force of ammonium nitrate-fuel oil (ANFO) explosives.

o. 1960. Detaclad process or explosive cladding, which is also called explosive bonding, was developed by the DuPont Company.

p. 1960. Detacord, detaflex flexible cord explosive, and detasheet flexible sheet explosives were developed by the DuPont Company.

q. 1964-1973. The war in Southeast Asia (SEA) (Vietnam) was characterized by an imbalance of ammunition supplies to meet the peculiar requirements of a longer, different type of war than had been anticipated. In the beginning, much of the war had to be fought with the ammunition surpluses from World War II and Korea. Critical shortages developed on those ammunition items which were best suited for the type of war being fought. Ammunition supply rates had to be adjusted constantly because production problems at home delayed filling vital requirements. The expanded use of the helicopter in this war and the fielding of rapid firing armament, such as the "Gatling" 40mm automatic cannon raised the supply rates far beyond the planners' expectations. The demand for signaling devices, such as the M18 colored smoke grenades, doubled, tripled,

and continued to rise until the ammunition supply rates for the grenades were as much as 100 times the World War II and Korea rates. Due to ammunition shortages, terrain, climate, and guerrilla warfare, the United States troops were often forced to rely upon field expedients during their missions. A new development program called ENSURE (Expedited Non-Standard Urgent Requirement), whose function was to meet troop demands for special items needed to support SEA operations, was established by the Defense Department. Many of the ENSURE items fielded under this program were ammunition related and are now standard items for Army use. For example, although flamethrowers were used extensively in SEA, a stand-off capability to project flame was needed to reduce the vulnerability of the operator to enemy fire. From this ENSURE requirement, a 66mm multishot flame rocket launcher (M202 and M202A1) was developed. The resulting M74 incendiary TPA incendiary 66mm rocket was fielded and is now a standard item. The rocket is filled with TPA (thickened pyrophoric agent), which consists of triethyl aluminum (TEA) thickened with polyisobutylene (PIB). Other significant ENSURE developments were a broad range of various 40mm cartridges and signaling devices, improved mines, and pyrotechnics for battlefield illumination.

r. 1973. The problem of managing a rapidly increasing number of conventional ammunition items in the Army inventory was addressed at the conclusion of the war in Vietnam. Although many items developed as a result of the ENSURE program had justified their existence in combat, others were, by their very nature "field expedients" or were advance prototypes from ongoing development programs. In addition, many of the items in the inventory were obsolescent left over from Korea, World War II, and even pre-World War II assets. Accordingly, the Deputy Chief of Staff for Logistics (DCSLOG), Department of the Army, established an

Ammunition Proliferation Study Committee staffed with representatives from the developing arsenals (Picatinny, Frankford, and Edgewood), the National Inventory Control Point, and the United States Army Training and Doctrine Command (TRADOC). This committee, chaired by DCSLOG, was assigned to review every conventional ammunition item with a stock number or every ammunition item in development, and recommend deletion of all items considered not essential to the mission of the Army. Hundreds of obsolescent and non-essential items of ammunition and explosives were eliminated. Among these were FS smoke and M1 thickener. Ammunition supply rates were considered. For example, because of a low usage factor, the AN-M14 TH3 incendiary grenade was considered for elimination until it was established that the incendiary grenade was used only when necessary to destroy equipment to prevent enemy use; therefore, ammunition supply rates are not applicable to this item. Retention of the M18 violet smoke grenade was justified because violet was the second most used color for signaling in Vietnam; and more colors, not less, were needed to prevent the enemy from guessing the purpose of the signal.

s. 1973-1976. To protect tanks, the United States Army devoted considerable attention to the problem of rapidly screening tanks from enemy antitank rounds and missiles. A DARCOM Project Manager for Smokes and Obscurants was appointed to manage a program of developing and fielding countermeasures. One of the first items adopted for Army use was a British smoke grenade launcher, which fires salvos of red phosphorous (RP) UK L8A1 smoke screening grenades from armored vehicles. After launch, these grenades detonate in the air to form an immediate, dense white smoke cloud that obscures the tank from enemy view. Smoke grenade launchers have been developed for use in many of the armored vehicles in use or development today, including the M1 tank.

CHAPTER 3 GENERAL CHARACTERISTICS AND CLASSIFICATION OF ENERGETIC MATERIALS

3-1. Types of Energetic Materials. Energetic materials are chemical compounds, or mixtures of chemical compounds, that are divided into three classes according to use: explosives, propellants, and pyrotechnics. Explosives and propellants that have been properly initiated evolve large volumes of hot gas in a short time. The difference between explosives and propellants is the rate at which the reaction proceeds. In explosives, a fast reaction produces a very high pressure shock in the surrounding medium. This shock is capable of shattering objects. In propellants, a slower reaction produces lower pressure over a longer period of time. This lower, sustained pressure is used to propel objects. Pyrotechnics evolve large amounts of heat but much less gas than propellants or explosives.

3-2. Characteristics of Burning and Detonation.

Burning and detonation of energetic materials are exothermic redox reactions. The reaction is self-sustaining after an initial activating energy has been applied. On the basis of mass, the amount of energy released by propellants and explosives is comparable. However, this energy is considerably less than is produced by common fuels such as carbon burning in air. Propellant burning, or deflagration, is the very rapid burning that results from having a fuel and an oxidant in very close contact. In some propellants such as nitrocellulose, the fuel (which consists mainly of hydrogen and carbon) and oxygen are parts of the same chemical compound. In other propellants, finely divided discreet fuels and oxidants are mixed. The fuel may be a hydrocarbon or other readily oxidizable material such as aluminum. The oxidizer is usually an inorganic compound such as ammonium perchlorate or ammonium nitrate which contain oxygen in excess of the amount required for their own oxidation. Deflagration of propellants proceeds the same as normal burning. Combustion takes place on the surface and proceeds into the grain. The rate determining factors in the reaction are the rate of heat transfer into the propellant grain from the burning surface and the rate of decomposition of the propellant formulation. The rate of heat transfer depends on the pressure of the combustion products. The burning rate is defined as the rate at which the burning surface consumes a propellant grain in a direction normal to the grain surface. Detonation of explosives is a completely different process than deflagration. A shock wave moving at

supersonic speed proceeds through the explosive causing decomposition of the explosive material. The reaction rate is determined by the velocity of the shock wave, not by the rate of heat transfer. The velocity of the shock wave depends on the physical characteristics of the individual explosive material. The range of velocities is from about 2,000 meters per second to about 9,000 meters per second. The factors that affect the velocity include density, degree of confinement, and geometric configuration of the charge.

3-3. General Behavior of Pyrotechnic Compositions. Pyrotechnics is the technology of utilizing exothermic chemical reactions that, generally speaking, are non-explosive, relatively slow, self-sustaining, and self-contained. Pyrotechnic compositions are generally finely divided fuels such as metals, alloys, and hydrocarbons mixed with oxidizers.

3-4. Classification of Energetic Materials. There is considerable variation among the properties of the compounds that constitute each of the three major classifications of energetic materials.

a. The variation in the properties of explosives is put to practical use in armaments by an arrangement called an explosive train (figure 3-1). An explosive train consists of elements arranged according to decreasing sensitivity and increasing potency. The first element, the initiator, consists of a small quantity of highly sensitive material. The highly sensitive material consists of a primary explosive and other ingredients. Primary explosives are easily detonated by heat, spark, impact, or friction. In large quantities these materials are extremely hazardous because of their great sensitivity. The other ingredients in the priming composition increase the sensitivity of the mixture to the desired property, such as percussion or heat. The second element, the booster, contains a larger quantity of less sensitive but more powerful material called a secondary or high explosive.

The booster is used either as an intermediate stage to detonate material that is too insensitive to be detonated by the relatively weak initiator or to ensure complete detonation of the main charge. The main or bursting

charge, also a secondary explosive, is the least sensitive material but comprises the bulk of the explosive charge. Secondary explosives differ from primary explosives in three major ways. Small, unconfined charges (one to two grams) of secondary explosives, even though ignited, do not transfer easily from a burning or deflagration reaction to a detonation. Except in the case of dust clouds, ignition by electrostatic spark is difficult. The shock required for ignition is much greater for a secondary explosive than for a primary explosive. In some cases, two other elements, a delay and a relay, may be added to the explosive train between the initiator and booster. The delay is calibrated to prevent detonation of the booster for a specified length of time. A delay is considered a pyrotechnic device. A relay may be required to strengthen the relatively weak output of the delay to detonate the booster.

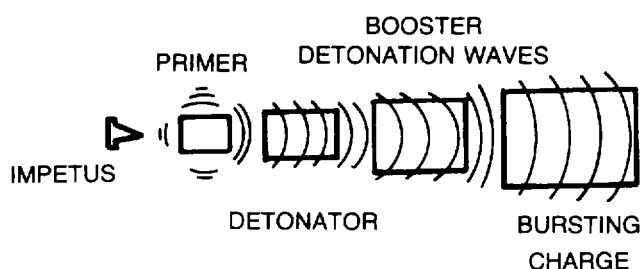

Figure 3-1. Explosive train.

b. An ignition train, which is used to ignite propellant charges, is shown in figure 3-2. The primer contains a priming composition which consists of a mixture of fuels and oxidants that are sensitive to stimuli such as impact, heat, or spark. Application of the appropriate stimulus causes ignition. The primer ignites the igniter which in turn ignites the propellant charge. The igniter is considered a pyrotechnic device.

c. Propellants are divided into four classes: single-base, double-base, triple-base, and composite. Division of the propellants into these classes is on the basis of composition, not use. Single-base compositions are used in cannons, small arms, and grenades; double-base compositions are used in cannons, small arms, mortars, rockets, and jet propulsion units; and triple-base compositions are used in cannon units. Composite compositions are used primarily in rocket assemblies and jet propulsion units. The choice of a propellant for a specific use is determined by ballistic and physical requirements rather than on the basis of composition. A given propellant

composition may be suitable for use in several applications.

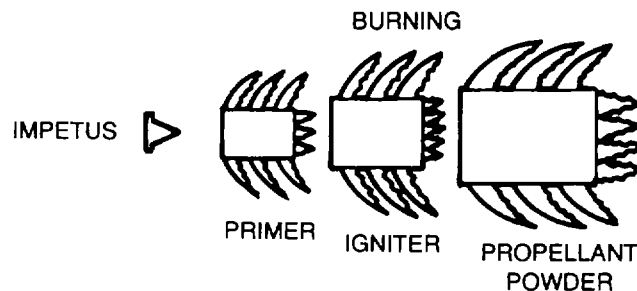

Figure 3-2. Ignition train.

(1) Single-base. These compositions contain nitrocellulose as their chief ingredient. In addition to a stabilizer, they may contain inorganic nitrates, nitrocompounds, and nonexplosive materials, such as metallic salts, metals, carbohydrates, and dyes.

(2) Double-base. This term has been applied generally to compositions containing both nitrocellulose and nitroglycerin. However, since other gelatinizers such as DEGN are used by other countries, a better definition of a double-base composition is one containing nitrocellulose and a liquid organic nitrate which will gelatinize nitrocellulose. Like single-base propellants, double-base propellants frequently contain additives in addition to a stabilizer.

(3) Triple-base. This term is applied to propellants containing three explosive ingredients with nitroguanidine as the major ingredient. The other two explosive ingredients are usually nitroglycerine and nitro-cellulose. As in the double-base propellant, other gelatinizers may be substituted for the nitroglycerine. The nitroguanidine in the formulation produces a lower flame temperature and a greater amount of gaseous combustion products. The lower flame temperature considerably reduces erosion of gun barrels and the greater amounts of gas produce a greater force on the projectile. Triple-base propellants also contain additives in addition to a stabilizer.

(4) Mixed nitrate esters. Two propellant compositions were developed in the United States to replace the triple-base formulation due to the shortage of nitro-guanidine. The XM35 composition contains nitrocellulose, TMETN, TEGDN and DEGDN. The higher force XM34 formulation contains nitrocellulose, BTTN, TMETN and TEGDN. The combination of mixed nitrate esters give higher gas volumes and lower flame temperatures than nitroglycerin alone.

(5) Composite. Most composite propellants contain neither nitrocellulose nor an organic nitrate. They generally consist of a physical mixture of a fuel such as metallic aluminum, a binder which is normally an organic polymer (generally a synthetic rubber which is also a fuel), and an inorganic oxidizing agent such as ammonium perchlorate. These are heterogeneous physical structures.

d. Pyrotechnic compositions are divided into the following categories according to use.

(1) Flares and signals. Flares burn to produce intense light that is used for illumination. Signals produce colored flames that are used as semaphores.

(2) Colored and white smoke. Colored smoke is used for signaling while white smoke is used for screening.

(3) Tracers and fumers. Tracers and fumers are small, smoke producing charges that are placed in projectiles. During the flight of the projectile, the charge burns. In a tracer, the smoke is used to track the flight of the projectile. A fumer produces smoke at the proper rate to fill the partial vacuum that movement through the air creates behind the projectile. This cuts drag and increases range.

(4) Incendiaries. Incendiaries produce large amounts of heat that cause fires.

(5) Delays and fuses. A delay is an element that consists of an initiator, a delay column, and an output charge or relay in a specially designed inert housing. The delay column burns for a predetermined amount of time. Delays are used to provide an interval between initiation and functioning of a device. A fuse is a cord of combustible material commonly used in demolition.

(6) Photoflash composition. Photoflash powders are loose mixtures of oxidizers with metallic fuels. When ignited, these mixtures burn with explosive violence in a very short time. The mixtures are used to provide light for military aerial photography, and in simulator devices.

(7) Igniters and initiators. These devices are used to ignite propellant charges and initiate detonation in explosive charges.

3-5. Chemical Nature of Energetic Materials.

Chemical properties of individual energetic materials are discussed in the appropriate chapters of this manual. The properties discussed for these materials include the following:

a. Heat of Fusion. The heat of fusion is the amount of heat necessary to transform (melt or fuse) a unit of solid into a liquid at the same temperature and standard pressure. This quantity is usually expressed in terms of calories per gram.

b. Heat of Vaporization. The heat of vaporization is the amount of heat necessary to convert a unit of liquid to vapor at the same temperature. This quantity is usually expressed in terms of calories per gram.

c. Heat of Sublimation. The heat of sublimation is the amount of heat necessary to convert a weight of solid directly into vapor in a constant temperature process. This quantity is usually expressed in calories per gram.

d. Heat of Detonation. Two quantities are usually given for the heat of detonation, one with liquid water in the reaction products and one with gaseous water in the reaction products. The test used to determine these quantities uses a standard calorimeter. When the water is allowed to condense to liquid, the total heat produced by the detonation reaction is measured. The heat of detonation with gaseous water more accurately reflects the process of detonation in a non-laboratory setting. However, the results are less reproducible.

e. Heat of Combustion. The heat of combustion is the amount of heat produced when a material is burned. This differs from the heat of detonation because the products formed are different. Generally, the products formed in combustion are at a lower energy level than the products formed during detonation. For example, carbon monoxide and carbon dioxide may be products of both detonation and combustion for a particular explosive. However, the detonation process might produce more carbon monoxide, while combustion might produce more carbon dioxide.

f. Sensitivity. Various external stimuli can cause release of the energy contained in energetic materials. Knowing the response of individual energetic materials to specific stimuli is important from the point of view of safety and in determining the suitability of a material for a specific application.

(1) The response to a blow is called impact sensitivity. Traditionally, explosives have been subjected to falling weights to measure impact sensitivity. The results are then reported as the distance a given weight must fall to produce detonation 50 percent of the time. The physical significance of this type of test has recently been questioned. The results are more qualitative than quantitative. For example, there is no question that lead azide is much more impact sensitive than TNT and that TNT is much safer to handle than lead azide. But the quantitative meaning of "much more impact sensitive" is ill-defined. The results of this test should be considered for general comparisons among explosive compounds. These same remarks are also valid for sensitivity to friction. Tests which are more applicable to specific hazards and applications such as the SUSAN test and 40-foot drop test are discussed in Chapter 5.

(2) Sensitivity of an explosive to shock is a very reproducible quantity. Shocks generated by a donor explosive can cause detonation in another explosive material. The strength of the shock wave required is a relative measure of the sensitivity of the material under test. In practice, a strong shock is produced and attenuated in an inert medium. The width of the medium that will allow detonation in 50 percent of the trials is reported as the test result. These tests are called gap tests. Gap test results are much more reliable data than impact test results, although there is some dependence on the geometry of the test apparatus. Gap test procedures are covered in detail in Chapter 5.

(3) Electrostatic sensitivity is an important quantity because of safety. Some explosives can be detonated from the shock of a person charged with static electricity. The test procedure used to determine electrostatic sensitivity is covered in Chapter 5.

(4) Thermal sensitivity is an important quantity which needs to be determined in considering explosives for applications. In some cases, such as in the warhead of a high speed intercepting missile, the heat generated during flight can cause detonation of explosive charges that are not highly resistant to heat.

g. *Brisance*. Brisance is the shattering capability of an explosive. Several tests are commonly used to determine brisance. In the sand test 0.400 grams of the explosive are placed in 200 grams of sand and detonated. The amount of sand crushed by the explosive is a measure of brisance. The plate dent test, in which a sample of the explosive is detonated in close

proximity to a metal plate, is also used to measure brisance. The size of the dent is proportional to the brisance. Another method of measurement involves detonating a sample of explosive on top of a cylinder made of copper and measuring the contraction in length of the cylinder. The number, size distribution, and velocity of fragments produced by an explosive in a projectile is also related to the brisance of the explosive.

h. *Detonation Velocity*. The detonation velocity is simply the rate at which the detonation reaction proceeds through an explosive. This quantity is closely related to the brisance. With a limited number of exceptions, increased detonation velocity increases brisance.

i. *Power*. The power of an explosive is the total energy available to do work. This is a different quantity than brisance, even though on the surface they appear rather similar. Consider two explosives, ammonium nitrate and RDX. If a charge of each is placed beneath a boulder, the ammonium nitrate might hurl the boulder many meters but the RDX might pulverize the boulder into many fragments. The former quality is power whereas the latter quality is brisance. Power is measured by the Trauzl lead block test in which a sample of the explosive is detonated in a cavity in a lead block. The expansion of the cavity is a measure of the power of the explosive. The ballistic pendulum and ballistic mortar tests are also used to measure power. A heavy weight is accelerated by the detonation of an explosive. The swing of the pendulum or movement of the mortar's weight is a measure of the power of the explosive. The oxygen balance of the explosive is closely related to the power. The oxygen balance is the ratio of oxygen contained in the explosive material to the amount of oxygen required for complete oxidation of the explosive material. Explosive compositions with better oxygen balances are more powerful.

j. *Stability*. Stability is the ability of energetic materials to retain, unaltered, such properties as detonation velocity and sensitivity after long periods of storage under adverse conditions. All energetic materials are unstable to some extent. The degree of instability varies greatly. TNT can be stored for 20 years with no change in stability while other explosives, which are not used by the military or commercially, decompose and/or detonate in a matter of days or minutes. Several tests are used to measure stability of explosives. In the heat tests, a sample of the explosive is subjected to a specified temperature for a given amount of time. The

sample is then weighed and any loss of weight above the evaporation of moisture indicates volatility or decomposition. The heat tests are usually carried out at 75°C or 100°C. In the 75±C test a ten gram sample is heated for 48 hours then cooled and weighed. In the 100°C heat test two samples of the explosive weighing 0.60 grams each are heated to 100°C. One of the samples is withdrawn after 48 hours, cooled, weighed, and replaced in the oven. This sample is then withdrawn after an additional 48 hours of heating, cooled and weighed again. The second sample is left in the oven for 100 hours and any detonation or ignition is reported. The 100°C heat test is a more accurate predictor of stability than the 75° test. The currently preferred test of this type, however, is Thermal Gravimetric Analysis (TGA). A TGA can be run in two ways. The temperature can be held constant and the weight is monitored continuously. The data is then plotted as weight or percentage of weight change versus time. The other method commonly employed is to vary the temperature at a specified rate and plot the weight or percentage of weight change versus temperature. The results reported in this manual use a sample size of approximately 10 milligrams and a heating rate of 10°C per minute. The vacuum stability test is used extensively to measure stability. In this test a sample of an explosive is subjected to both elevated temperatures and vacuum. The amount of gas evolved after a specified time is recorded as the test result. The test may be run at any temperature but between 100°C and 150°C is the most common temperature range. In Chapter 5 the test procedure is given in detail. A test that is sometimes performed is the KI (potassium iodide) test. In this test a strip of potassium iodide starch test paper is suspended in a test tube with the material under test. The top of the strip is saturated with a 50 percent water 50 percent glycerin solution. The sample is heated. As the heating continues, moisture condenses on the test tube up to a certain point. The position of the test paper is moved up so the line of demarcation between the dry and glycerin-water soaked portions is kept level with the ring of condensation. The appearance of discoloration of the upper half of the test paper indicates the test is finished. The results are

reported as the amount of time from the start of heating to the end of the test. A blank is run at the same time to ensure the test results are greater than the time required for the blank to indicate. This test is of limited applicability. The discoloration is caused by acidity, so the major application is testing nitrocellulose at 65.5°C and nitroglycerin at 82.2°C for purity. A test that is performed on explosives to determine stability is the LLNL reactivity test. In this test a sample of explosive is heated at 120°C for 22 hours. A two stage chromatography unit is used to measure the individual volumes of N₂, NO, CO, NO₂, and CO₂. The result is the sum of the volumes of these gasses per 0.25 gram of sample. A test that yields a great deal of useful information is the Differential Thermal Analysis (DTA). Detailed testing procedures for explosives are given in Chapter 5. In the usual DTA analysis, identical containers are set up. The sample under test is placed in one of the containers and a reference substance is placed in the other. The containers are placed in identical thermal geometries with temperature sensors arranged to give both the temperature of each container and the difference in temperatures between containers. The data are displayed as DTA thermograms; the temperature difference is plotted against the temperature of the sample. The standard reference material chosen is one with thermal behavior that does not change rapidly. Such a plot is nearly a straight line if the sample under test also has no rapidly changing thermal behavior. A straight line is also produced if the test sample has thermal characteristics similar to the reference substance. Excursions above and below a background line result from endothermic or exothermic changes. The DTA analyses permit interpretation for phase changes, decomposition and kinetic information, melting points, and thermal stability. Another very useful test is pyrolysis. A sample is placed in a pyrolysis chamber that is then flushed with helium. When the air has been swept out, the temperature of the chamber is raised at a constant rate. Gas evolution is measured as a function of temperature by a bridge formed by two thermal conductivity cells. The pyrolysis test results are plotted with the DTA results for each explosive.

3-5(3-6 blank)

CHAPTER 4

CHEMISTRY AND PHYSICS OF ENERGETIC MATERIALS

4-1. Introduction. This chapter contains a discussion of the physical processes involved in the detonation and deflagration of energetic materials. The initiation phenomenon, blast effects in surrounding media, and shaped charge principles are also discussed.

4-2. The Ignition-Initiation Process. Direct ignition or initiation of explosives by an external stimulus is caused by the thermal decomposition of the explosive involved. Impact, friction, electrostatic discharge, gap, and other sensitivity tests produce hot spots in the material under test. A hot spot is a localized region of higher than average temperature. Existence of the hot spots is confirmed by the lag time between the application of the stimulus and the detonation or ignition. For example, if a two kilogram weight falls 30 centimeters on a 20 milligram sample of RDX, ignition occurs within several hundred microseconds. Assuming that the impact energy heated the sample uniformly and that no heat loss occurred, the temperature of the RDX would be about 250°C. At that temperature, the ignition lag for RDX is about one second. In solid explosives, energy is transferred out of the hot spot in the form of shock and rarefaction waves. The shock wave heats the surrounding explosive. Some hot spots fail to detonate the surrounding material. Whether or not an explosion occurs depends upon the initial strength of the shock wave and how rapidly the shock decreases at the hot spot interface. Several modes of hot spot generation which have been proposed include:

- a. Adiabatic heating due to compression of gas spaces can operate in impact and friction initiation of pressed solid and liquid explosives.
- b. Frictional heating on a confining surface or on a grit particle can cause a hot spot. This mode of initiation can operate in impact and friction initiation of pressed solid and liquid explosives.
- c. Hot spots can be caused by the intercrystalline friction of the energetic material. This mode of initiation can operate in impact and friction initiation of pressed solid explosives.
- d. Viscous heating at high rates of shear can create hot spots. This mode of initiation is operative only at strong shock inputs. This is the main mode of

initiation and propagation in homogeneous liquid explosives or defect-free single crystals.

e. Heating by plastic deformation at a sharp point can cause hot spots. This mode is operative in the shock initiation of solid explosive compacts and explosive liquids containing inhomogeneities.

f. Hot spots can be formed by the mutual reinforcement of relatively weak shock waves at inhomogeneities in the shocked medium. This mode is operative in the shock initiation of solid explosive compacts and explosive liquids containing inhomogeneities.

g. Particles which are spalled off crystallite by an incoming shock wave can form hot spots by impact on the opposite wall of a void. This mode is operative in the shock initiation of solid explosive components or liquid explosives containing inhomogeneities.

h. Micro shaped charged jets which are formed by shock waves acting on concave walls of bubbles, cavities, or voids can cause hot spots. This mode is operative in the shock initiation of solid explosive compacts or liquid explosives containing inhomogeneities.

4-3. The Deflagration Process. Deflagration of a propellant proceeds in a direction normal to the surface of the propellant grain. Material is consumed in parallel layers, so the geometry of the grain does not change as the burning takes place. Propellant is volatilized by heat transfer from the flame zone which is in the gas phase above the propellant surface. An increase in the ambient pressure causes the flame zone to move closer to the propellant surface. This increases the rate of heat transfer. The more rapid heat transfer causes an increase in the rate of volatilization of the propellant which correspondingly increases the rate of deflagration. If the flow pattern of the hot combustion gases is perturbed and penetrates the flame zone, an increase in the rate of heat transfer may occur. An increase in the flame temperature also causes an increase in the rate of heat transfer. The flame temperature is a function of the propellant composition. Propellants tend to burn more smoothly at high pressure than at low pressure.

4-4. Deflagration to Detonation Transfer (DDT). In some energetic materials deflagration can build to detonation. In a DDT, local ignition forms a convective flame front. A convective flame front is an ignition wave which is propagated by the passage of hot combustion gases through the pores of the charge. The hot gases are forced into the pores of the charge by the pressure built up as a result of charge confinement. The hot gases heat the pore walls and are consequently cooled. A continuous flow of gases is required to raise the temperature of the pore walls to the point of ignition. Ignition of the pores causes the convective flame front to advance and as the convective flame front advances, the pressure increases linearly with time. The pressure increase causes compaction of most porous charges. Formation of a post convective or compressive wave marks the beginning of accelerated pressure buildup. Subsequent coalescence of the compressive waves into a shock wave completes the DDT. The degree of compaction of the explosive determines how much material is consumed before the DDT occurs. The runup distance is defined as the length of material which will deflagrate before detonation occurs. The following subparagraphs describe the physical phenomenon involved in the variation of runup distance with density of the explosive material.

a. At crystal density and in cast charges there is no porosity and the explosive is impermeable. A convective flame front cannot form. A DDT can occur only if the explosive is relatively sensitive and there is a rapid pressure rise in the ignition region that produces a sufficiently strong shock wave. Some high explosives when unconfined at this density will burn without detonation. Under sufficient confinement, however, these explosives will detonate. Other more sensitive explosives will explode even without confinement.

b. The introduction of porosity into a charge does not mean that the charge will be permeable since the pores may or may not be interconnected. If the pores are not connected, permeability is very low and essentially negligible. The criteria for DDT in this case will be the same as for cast charges. The runup distance will be smaller, however, because the porosity will increase the exposed surface area of the explosive.

This will cause 4-2 the rate of change of the pressure with respect to time to be slightly higher than for the cast material. If an explosive does not undergo DDT at crystal density, then there would probably not be a DDT at this density.

c. As the porosity increases, the fraction of pores which are interconnected increases rapidly. However, the permeability of the charge should remain small. Under these conditions a convective flame front can be established. Establishment of the front will depend on the permeability of the charge, the adiabatic flame temperature of the explosive, ignition characteristics of the explosive, and the ability of the confinement to allow a critical driving pressure to be established. The onset of convective burning indicates that nonnegligible amounts of energy can be transported by gas flow beyond the ignition region. However, only very small quantities of gas can flow out of the ignition area over a time period as long as 100 microseconds. The runup distance for DDT in this case would be less than for charges with either lesser or greater porosity.

d. As more porosity is introduced into the charge, the gas flow can no longer be described as choked. Enough pores are connected to permit flow which may be described as steady state. The increased permeability for this case leads to smaller rates of pressure increase near the ignition point. Burning for a longer period of time is required before the rate of pressure increase begins to accelerate. DDT occurs only after the acceleration occurs. A sharp rate of pressure increase is required to produce compressive waves which can coalesce into shock waves. The runup distance is correspondingly increased.

e. For very permeable charges, the runup distance increases with increasing porosity. Energy losses from the burning region can be great enough to prevent a rapid enough rate of pressure rise to cause DDT. In this case, the pressure builds relatively slowly (in one to two hundred microseconds) to a high level. The high pressure crushes the porous material immediately around the ignition region. The greater density crushed material, upon combustion, may then produce a rapid enough pressure rise to cause DDT. The runup distance for this case is the longest of any of the cases discussed.

4-5. The Detonation Process.

a. Detonation is caused by a self-sustaining shock wave which passes through an explosive material. The velocity of the shock wave is also called the velocity of detonation. A shock wave is a very rapid, almost discontinuous change in pressure. Beyond the range of the pressures involved in transmission of sound through a medium, the propagation velocity of a pressure wave increases as the pressure increases. Shock waves are formed by a pressure pulse of sufficient amplitude. The high pressure region of the pressure pulse moves faster than the low pressure region and so catches up as shown in figure 4-1. The shock wave will continue to have the sharp pressure rise shown in figure 4-1c until the wave is damped out. The dimension of the x-axis can be either distance or time. Five variables relate the state of the region in front of the shock wave and the region behind the shock wave. The variables are illustrated in figure 4-2. The shock velocity is the velocity at which the shock wave moves through the material. The shock velocity is greater than the sound velocity of the material at a given density. The particle velocity is the velocity attained by the material as a result of the acceleration of the shock wave. Particle velocity is in the same direction as shock velocity. Pressure, density, internal energy, and temperature increase as a result of the passage of the shock wave.

b. To derive relationships between the variables that specify shocked and unshocked material, refer to figure 4-3. We assume the shock front is stationary and the material is moving at the shock velocity through the shock front. Application of the laws of conservation of mass, momentum, and energy yields the following relationships among the variables.

(1) In a given amount of time, t , mass moves from one side of the shock front to the other side. By definition, mass, m , is given as a function of density, ρ , and volume, V , by the equation:

$$m = \rho V \tag{4-1}$$

The volume, V , can be expressed in terms of area, A , and length, L , by the equation:

$$V = AL \tag{4-2}$$

The length, L , is the distance a particle travels in our assumed time interval, t , times the velocity, v :

$$L = tv \tag{4-3}$$

By figure 4-3 the velocity can be seen to equal:

$$v_0 = (v - u_0) \tag{4-4}$$

and

$$v_1 = (v - u_1) \tag{4-5}$$

By equations 4-1 through 4-5 the mass entering the shock front is:

$$\begin{aligned} m_0 &= \rho_0 v_0 \\ m_0 &= \rho_0 AL \\ m_0 &= \rho_0 At(v - u_0) \end{aligned}$$

Similarly, the mass leaving the shock front is:

$$\begin{aligned} m_1 &= \rho_1 v_1 \\ m_1 &= \rho_1 AL_1 \\ m_1 &= \rho_1 At(v - u_1) \end{aligned}$$

Invoking the principle of conservation of mass:

$$\begin{aligned} m_0 &= m_1 \\ \rho_0 At(v - u_0) &= \rho_1 At(v - u_1) \\ \rho_0(v - u_0) &= \rho_1(v - u_1) \end{aligned} \tag{4-6}$$

(2) In our system the force produced is the pressure difference across the shock acting on the cross-sectional area:

$$F = (P_1 - P_0)A$$

The rate of increase in momentum of the system is the final momentum less the initial momentum per unit time or:

$$\text{momentum change}/t = (mu_1 - mu_0)/t$$

By equations 4-1 through 4-5:

$$\text{momentum change}/t = [p_1 A t u_1 (v - u_1) - p_0 A t u_0 (v - u_0)]/t$$

Setting the force equal to the rate of momentum increase per unit time:

$$(P_1 - P_0)A = [p_1 A t u_1 (v - u_1) - p_0 A t u_0 (v - u_0)]/t$$

Cancelling and rearranging yields:

$$P_1 - p_1 u_1 (v - u_1) = P_0 - p_0 u_0 (v - u_0) \tag{4-7}$$

(3) The rate of work being done on the system, w , per unit time, t , is given by the equation:

$$w/t = p_1 A u_1 - p_1 A u_0$$

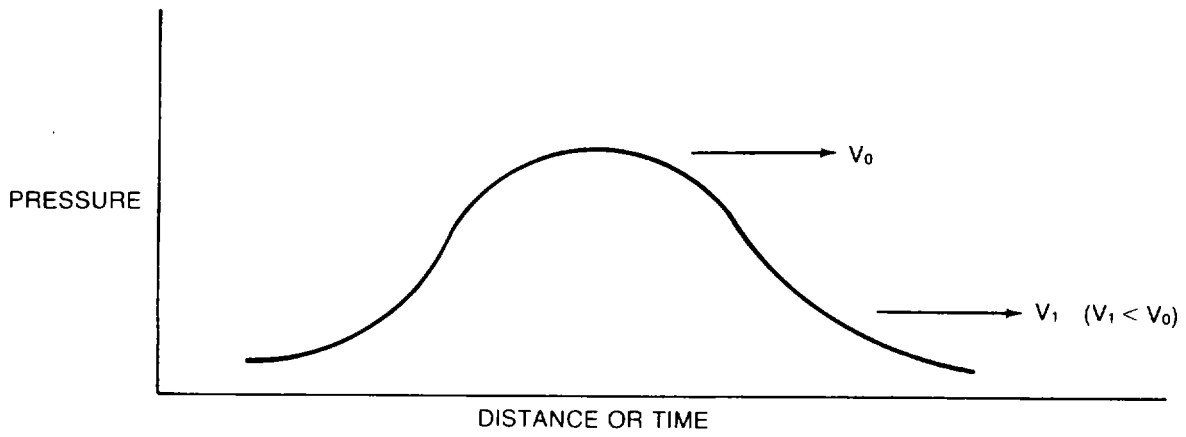

A. A PRESSURE PULSE

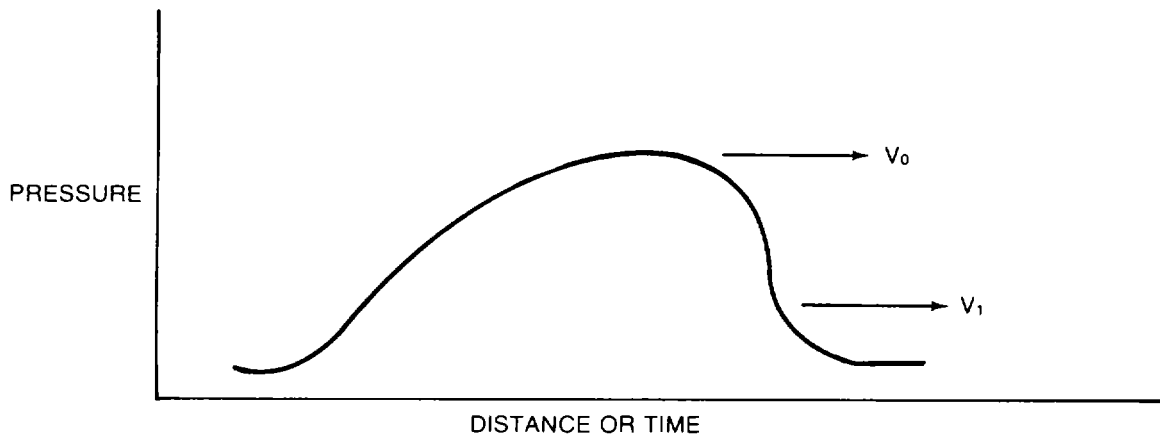

B. DIFFERENTIAL VELOCITY CAUSES THE LEADING EDGE TO BECOME SHARPER

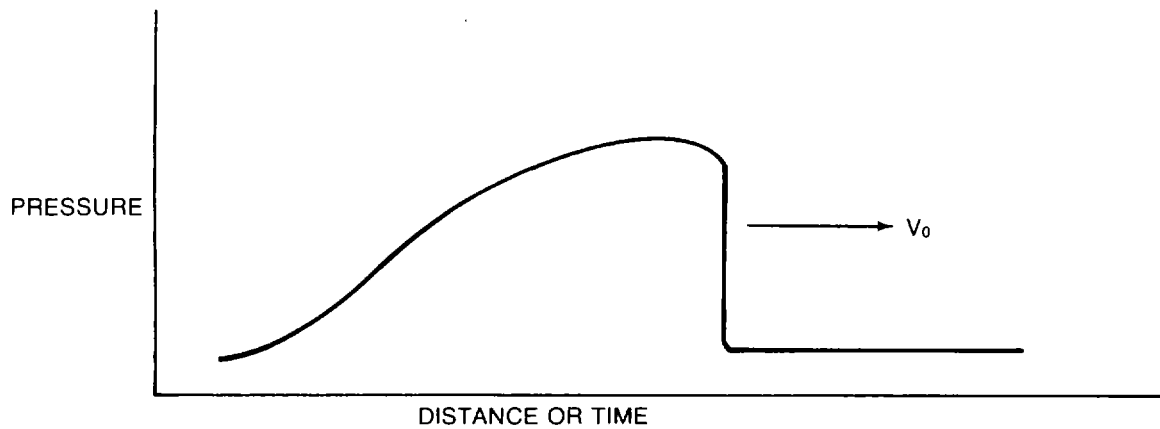

C. A SHOCK WAVE

Figure 4-1. Shock wave formation.

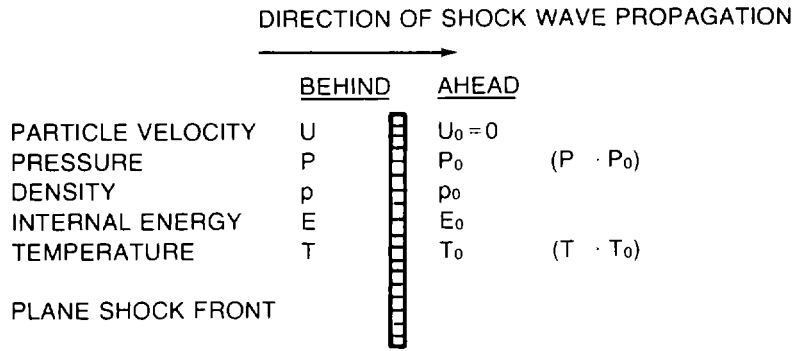

Figure 4-2. Steady plane shock front.

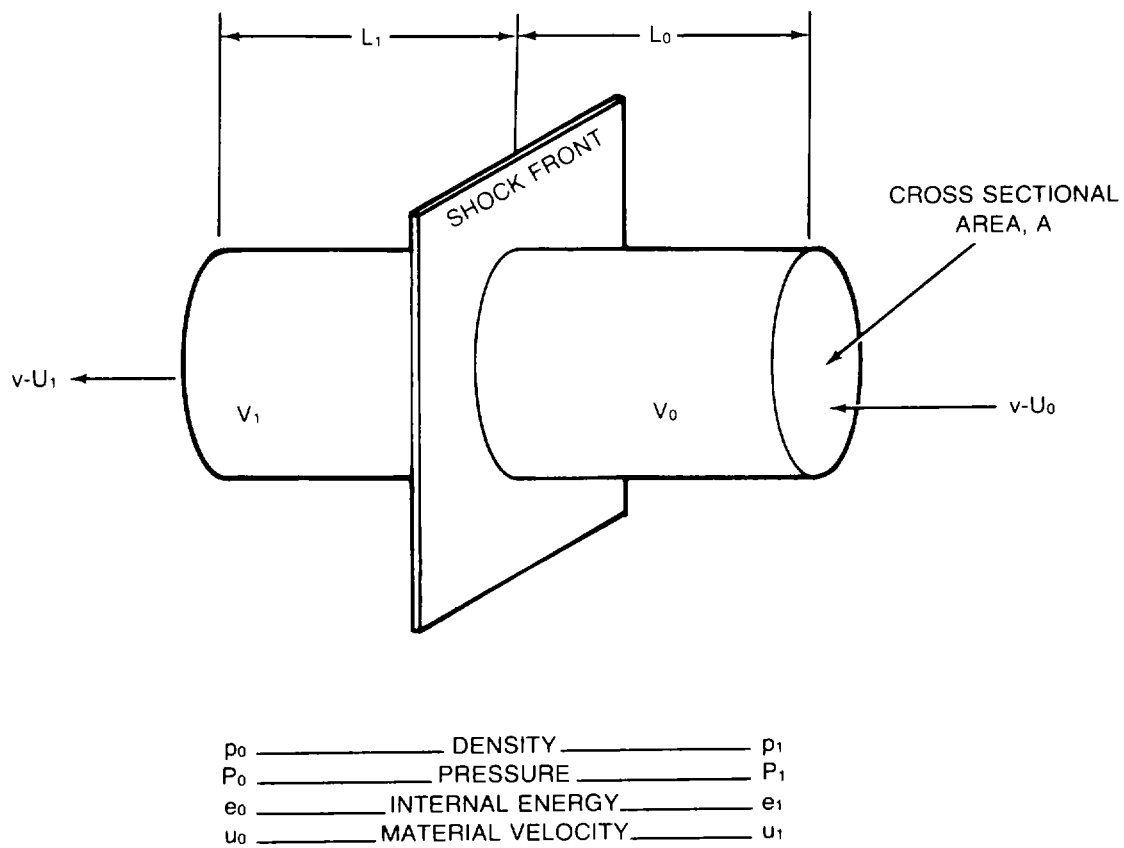

Figure 4-3. Control volume or mass passing through a shock front.

The rate of increase of energy per unit time is the difference between the rate of change of the sum of the internal and kinetic energies in the initial and final state:

$$\text{increase energy } /t = [(\rho_1 A L_1 e_1 + 0.5 \rho_1 A L_1 u_1^2) - (\rho_0 A L_0 e_0 + 0.5 \rho_0 A L_0 u_0^2)] /t$$

Using equations 4-1 through 4-5 the increased energy can be expressed as:

$$[(A t p_1 (e_1 + 0.5 u_1^2) (v - u_1) - A t p_0 (e_0 + 0.5 u_0^2) (v - u_0^2)) /t$$

Equating the work done on the system with the rate of energy increase and canceling the t's:

$$\rho_1 u_1 A - \rho_0 u_0 A = A p_1 (v - u_1) (e_1 + 0.5 u_1^2) - A p_0 (v - u_0) (e_0 + 0.5 u_0^2)$$

Canceling the A's yields:

$$\rho_1 u_1 - \rho_0 u_0 = p_1 (v - u_1) (e_1 + 0.5 u_1^2) - p_0 (v - u_0) (e_0 + 0.5 u_0^2)$$

Rearranging terms yields:

$$\rho_1 u_1 - p_1 (v - u_1) (e_1 + 0.5 u_1^2) = \rho_0 u_0 - p_0 (v - u_0) (e_0 + 0.5 u_0^2) \tag{4-8}$$

(4) Equations -6, 4-7, and 4-8 are called jump equations because the state variables jump from one value to another very rapidly across the shock. To these, another relationship tying together any of two state variables (P, v, u, e, t, p) which is specific for a given material is needed. An equation of state, which completely describes the material is more than is needed. A simpler relationship called the Hugoniot equation suffices. The Hugoniot is determined experimentally. The relationship can be obtained by measuring shock pressure and velocities at various shock states, or shock velocity and particle velocity, or any two of the state variables simultaneously. The Hugoniot which describes the relationship between the shock velocity, v , and particle velocity, u , has been found to be:

$$v = c_0 + s u \tag{4-9}$$

where c_0 is the sound velocity in the medium and s is a constant that is related to the specific heat and thermal expansivity of the material. This relationship is not a path along which the variables change, but is actually a locus of solutions or discrete shock states. Table 4-1 lists the values of c_0 and s for several explosives in the unreacted state.

Table 4-1. Unreacted Hugoniot Data

Explosive	Density in grams per cubic centimeter	Temperature °C	cc in millimeters per microsecond	s	Range of u (by experiment) in millimeters per microsecond
Ammonium nitrate	0.86	25	0.84	1.42	0.81 - 2.32
Composition B	1.70	25	3.0 ± 0.04	1.73	0.0 - 1.5
Composition B	1.68	25	2.71 ± 0.05	1.86 ± 0.07	0.0 - 0.9
DATB	1.78	25	2.45 ± 0.04	1.89 ± 0.06	0.0 - 1.2
H-6	1.76	25	2.83 ± 0.07	1.70 ± 0.08	0.0 - 1.1
H-6	1.76	25	2.65	1.98	0.0 - 2.0
HBX-1	1.75	25	2.93 ± 0.08	1.65 ± 0.10	0.0 - 1.0
HBX-3	1.85	25	3.13 ± 0.02	1.61 ± 0.02	0.0 - 1.0
HNS	1.38	25	0.61 ± 0.21	2.77 ± 1.09	0.0 - 0.5
HNS	1.57	25	1.00 ± 0.05	3.21 ± 0.10	0.0 - 0.7
75/25 Octol	1.80	25	3.01 ± 0.4	1.72	0.0 - 1.2

Table 4-1. Unreacted Hugoniot Data - Continued

Explosive	Density in grams per cubic centimeter	Temperature °C	cc in millimeters per microsecond	s	Range of u (by experiment) in millimeters per microsecond
50/50 Pentolite	1.67	25	2.83 ± 0.4	1.91	0.0 - 1.2
PETN	0.82	25	0.47	1.73	0.76 - 3.50
PETN	1.0	25	0.76	0.66	0.28 - 0.42
PETN	1.59	25	1.33 ± 0.08	2.18 ± 0.27	0.03 - 0.37
PETN	1.60	25	1.32	2.58	0.2 - 0.4
PETN	1.72	25	1.83	3.45	0.2 - 0.6
PETN	1.55	110	-0.6 ± 0.5	8.7 ± 1.7	0.24 - 0.29
RDX	1.0	25	0.40	2.00	0.44 - 2.60
RDX	1.54	25	0.7	3.2	0.25 - 0.6
RDX	1.58	180	0.71 ± 0.24	4.22 ± 0.42	0.25 - 0.32
RDX	1.64	25	0.70 ± 0.18	4.11 ± 0.37	0.35 - 0.47
RDX	1.80	25	2.87	1.61	0.75- 1.6
RDX	1.64	25	1.93 ± 0.05	0.666 +0.168	0.11 - 0.35
TATB	1.85	25	2.34 ± 0.07	2.32 ± 0.08	0.3 - 1.4
TNT	1.62	25	2.93	1.61	0.75- 1.6
TNT	1.63	25	2.57	1.88	0.0- 1.25
TNT	1.62	25	2.27 ± 0.30	2.65	0.0 - 0.6
TNT	1.62	25	2.99	1.36	1.0- 1.5
TNT	1.61	25	2.39 ± 0.03	2.05 ± 0.03	0.0 - 1.4
TNT	1.64	25	2.08 ± 0.13	2.3	0.2 - 1.4
TNT	1.64	25	2.4	2.1	0.1 - 0.5
TNT (liq)	1.47	92	2.14	1.57	0.8 - 1.7

By substituting terms from equations 4-6, 4-7, and 4-8 into equation 4-9 and solving, we can obtain more forms of the Hugoniot, for example:

$$P = \rho_0(c_0u + su^2) \quad (4-10)$$

(5) Three planes or two dimensional plots are used to describe the shock properties and shock histories of materials. They are the distance-time (x-t) plane, the pressure-particle velocity plane (P-u) described by equation 4-10, and the pressure-specific volume (P-vs) curve.

(a) The x-t plane is used to display the positions of shocks, material surfaces, and rarefactions (the opposite of a shock) in time and distance.

Figure 4-4 shows a simple collision of two materials. (1) is the surface of the target and (2) is the front surface of a flyer plate which is a small mass that impacts the target at a very high velocity. The slope of (2) is the plate velocity, (3) is the impact point when the two materials meet, (4) is the forward going shock in the target, (5) is the interface of the plate and target moving slowly to the right, (6) is the left going shock driven back into the flyer, and (7) is the back surface of the flyer. All slopes on this plot are velocities. As the shocks reflect and rarefactions fan out and the surfaces move, the x-t plot is used to keep track of the variables.

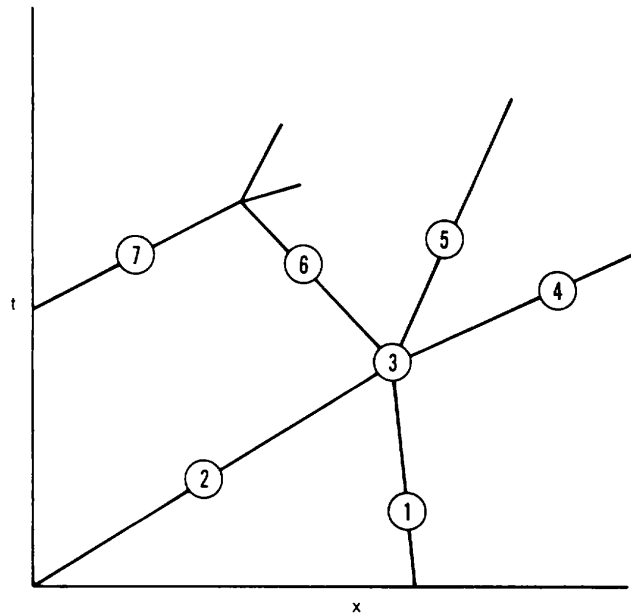

Figure 4-4. Shock properties in the x-t plane.

(b) The P-u plane is where the Hugoniot are normally plotted. An example is shown in figure 4-5. This plot is used to perform graphical solutions to impact problems (uniaxial). Intersections of Hugoniot equations represent simultaneous solutions of two Hugoniot equations. Chords drawn from initial to final states on this plot have slopes proportional to the shock velocities of the final state in that particular material. Figure 4-5 shows the solution of an impact problem where a flyer, material N at a velocity of u_0 impacts a stationary target, material M. The final pressure and particle velocity after the impact are the same in both flyer and target and are P_1 and u_1 respectively. (1) is the chord drawn from the initial state to the final state of the flyer. The slope is equal to $P_0 v_f$, the initial density times the shock velocity in the flyer. (2) is the chord drawn from the initial state to the final state of the target, the slope of the chord is $P_0 v_r$, the initial density of the target times the shock velocity in the target. The negative slope of $P_0 v_f$ indicates the shock in the flyer is traveling toward the left. The lines N and M are the P-u Hugoniot of two individual materials. The P-u Hugoniot is not fixed on the plane. The position of the plot relative to the P and u axis is not unique. The physical explanation for that is, a material specimen can exist at any pressure state regardless of bulk or particle velocity. The shape of the Hugoniot and the relation of slope to the axis is unique.

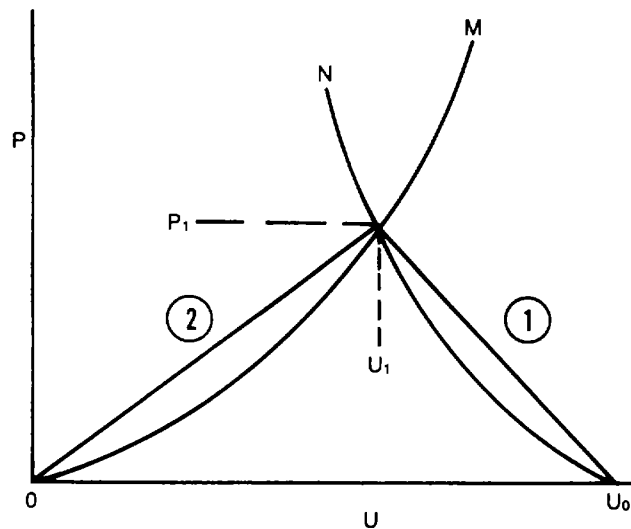

Figure 4-5. Shock properties in the P-u plane.

(c) The specific volume V_s is defined as the reciprocal of the density. Plots in the P-Vs plane, as shown in figure 4-6, are useful in describing the thermodynamics of the shock because areas on this plane represent work or energy per unit mass:

$$PV_s = \frac{\text{Force}}{\text{Area}} \cdot \frac{\text{Volume}}{\text{Mass}} = \frac{\text{Force} \times \text{distance}}{\text{mass}}$$

The Hugoniot position on this plane is unique.

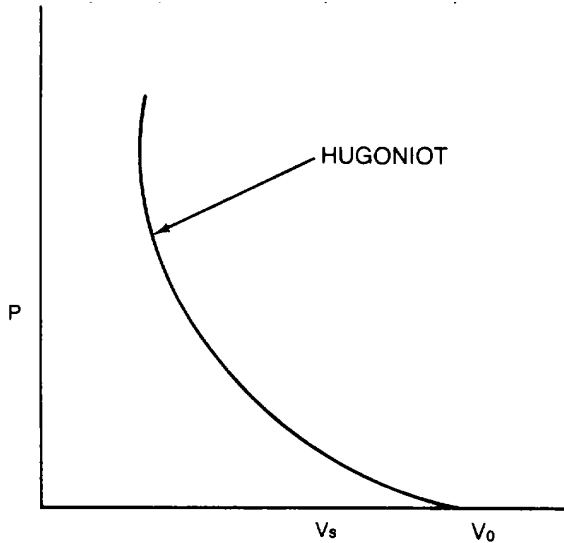

Figure 4-6. Shock properties in the P-Vs plane.

c. A detonation shock wave is self-sustaining because the energy added by the chemical reaction taking place behind the wave balances the losses due to normal attenuation. Figure 4-7 shows the pressure distribution of a detonation wave that is moving through explosive material. Chapman and Jouquet (CJ) developed the theory of shock wave propagation through explosive materials. The CJ conditions for each explosive are unique for that explosive at some unique or specified density. If we change the initial density, we will change the CJ conditions. The theory is based on these assumptions: that pressure is constant from the shock wave to the CJ point, that the pressure decays in a Taylor wave beyond the CJ point, that the reaction is complete and the products are in equilibrium at the CJ point, and that the energy in the Von Neuman spike is negligible in comparison to the energy in the reaction zone and so can be ignored. Figure 4-8 shows a representative plot of the Hugoniots of unreacted explosive and decomposition products under detonation conditions. The Rayleigh line connects the initial unshocked state, V_{s0} , with the final shocked state, V_F . Table 4-2 lists the reaction zone length (i.e., the length of the zone between the shock wave and the CJ point) for various explosives. Table 4-3 lists the detonation pressure in the reacting zone for various explosives. The pressure of the Von Neuman spike can be explained by referring to figure 4-8. The point that the Rayleigh line crosses the unreacted explosive Hugoniot, V_F , corresponds to the high pressure in the Von Neuman spike. This is obviously at a higher pressure than the CJ point.

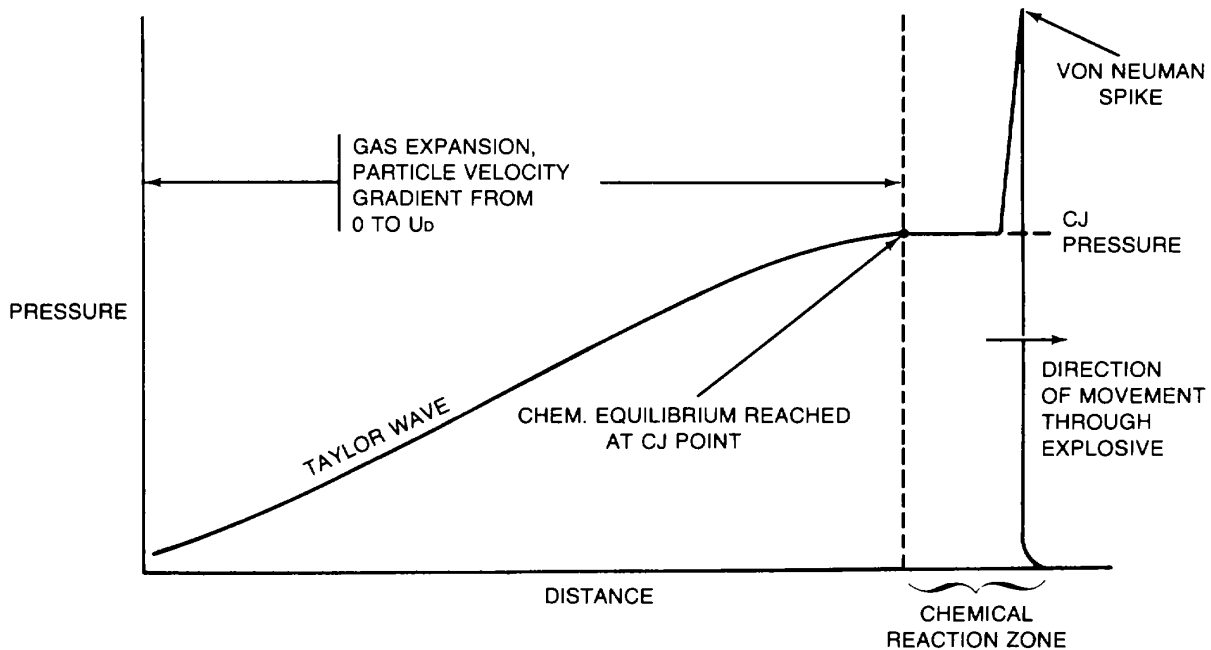

Figure 4-7. Detonation wave.

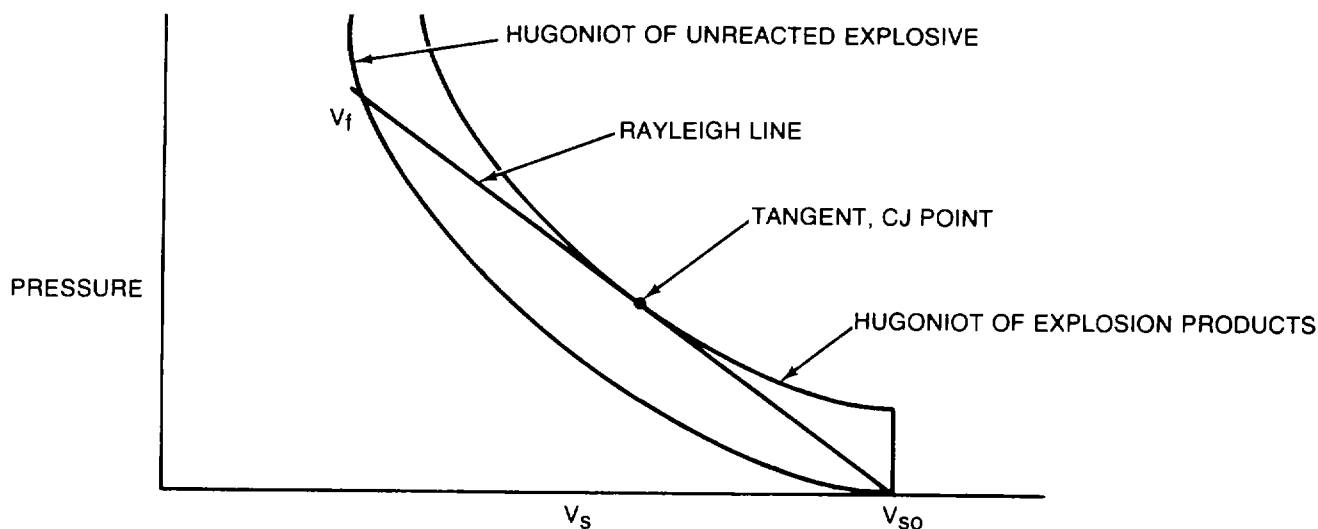

Figure 4-8. P-Vs plot during detonation.

Table 4-2. Reaction Zone Length

Explosive	Density, in grams per cubic centimeter	Approximate length, in millimeters
Amatol 80/20 Composition B	1.67	4
	1.67	0.13
HBX-1	1.60	0.19
Nitroglycerin	--	0.21
RDX (microporous) (single crystal)	1.30	0.826
	1.80	1.82
	1.80	2.90
TNT (pressed) (cast)	1.00	0.36
	1.55	0.32
	--	0.18
	--	0.13
	--	0.21
	1.59	0.70
	1.63	0.3
	1.615	0.42 at 291°K
(liquid)	1.70	0.55 at 77.4°K
	1.71	0.62 at 20.4°K
	--	0.9 at 100°C
	--	1.1 at 100°C
TNT/RDX 50/50	1.67	0.12

d. Several computer programs are available that predict the detonation characteristics of a compound from basic chemical and physical properties. One such program is based on the Becker-Kistiakowsky-Wilson (BKW) equation of state. The BKW program requires information about the initial state of the explosive and about the state of the detonation products. The information required for the initial explosive is elemental composition, heat of formation, density, and formula weight. The information required for the detonation products is elemental composition, heats of formation, co-volumes (the effective size of the molecules), and fits of each products ideal gas entropy as a function of temperature. If any solid detonation products are present, the density, molecular weight, and an equation of state are required. From this information the BKW program computes the equilibrium composition of the detonation products at specified temperatures and pressures, the Hugoniot curve, the CJ pressure, the CJ temperature, the CJ density, the detonation velocity, and the isentrope of the detonation products through the CJ point. The values of pressures and temperatures obtained from the program agree to within 20 percent of the values observed experimentally and the detonation velocity agrees to within 10 percent. This margin of error is caused by the assumption of the BKW equation that detonation is steady state. To perform time-dependent flow calculations of the detonation process, other programs are used. These include SIN, EIC, 2DL, and 2DE. These programs require an equation of state of the detonation products (such as BKW), an equation of state for the unreacted explosive, an equation of state for mixtures of unreacted and totally decomposed explosive, and an equation of state that describes the rate at which the explosive decomposes into detonation products.

Table 4-3. Detonation Pressures

Explosive	Density in grams per cubic centimeter	Pressure in kilobars	
		Measured	Calculated
Composition B, grade A	1.717	295	--
Composition B-3	1.715	287	--
Composition C-4	1.59	--	257
Cyclotol 77/23	1.752	316	--
DATB	1.78	259	250
HBX-1	1.712	220.4	--
HMX	1.89	390	394
HNAB	1.60	205	--
HNS	1.60	--	200
LX-14	1.833	370	--
Nitrocellulose (12.0 % N)	1.58	--	200
Nitrocellulose (13.35 % N)	1.58	--	210
Nitroglycerin	1.59	253	251
Octol 77.6/22.4	1.821	342	--
Pentolite 50/50	1.70	--	255
PETN	1.77	335	332
PETN	1.67	300	280
PETN	0.99	87	100
RDX	1.767	338	348
TATB	1.88	--	291
Tetryl	1.71	--	260
TNT	1.63	210	223

4-6. Blast Effects. When a high explosive is detonated, the solid charge is rapidly converted to gaseous products. This process, which occurs in about 0.001 second, develops very high temperatures and pressures. Of the total energy available, as much as half may be used to expand the bomb casing and the remainder is used to compress the surrounding environment.

a. *Blast Effects in Air.*

(1) When an explosive charge is detonated in air, the gaseous products expand rapidly and compress the surrounding air. The air moves outward with high velocity, thus initiating a shock wave. This layer of compressed air is bounded by an extremely sharp front called the shock front in which the pressure rises abruptly. The shock front moves outward with an initial velocity much greater than that of sound but, after a short distance, the velocity decreases rapidly.

The gaseous products of detonation move as a strong wind behind the shock front and are prevented by their own inertia from decreasing in velocity as rapidly as the pressure at the point of detonation decreases. As a result, a rarefaction effect is produced at this point and the pressure decreases. This condition of reduced pressure also moves outward, trailing the shock front. When the pressure becomes less than atmospheric, the wind reverses in direction and blows backward toward the point of detonation. Any light object, such as a leaf, when struck by the shock front, is rapidly carried away from the point of detonation and then is blown back almost to the original position when the wind reverses. The shock front, the high pressure area behind it, and the following rarefaction form a complete wave to which the terms blast and shock wave, generally, are applied (figure 4-9).

(2) While the duration of the positive pressure portion of the blast wave is about one-fourth that of the portion at less than atmospheric pressure, the amplitude of the pressure at the shock front is much greater than the amplitude of the decrease in pressure below atmospheric. The duration of the positive phase varies with the explosive charge and distance from the point of origin. In one case, the duration of the positive phase is of the order of 0.006 second at a distance of 15.5 meters from the bomb. A wall struck by such a blast wave is first pushed forward by the short, sharp, hammer-like blow of the positive pressure phase and then pulled backward by the much longer negative phase. Whether the wall falls forward or backward depends upon circumstances.

(3) Blast effect is measured by two criteria, peak pressure and impulse. Peak pressure is the pressure increase at the shock front or the highest pressure in the shock wave minus atmospheric pressure. Impulse is mathematically equal to the area under the time pressure curve for the duration of the positive phase (figure 4-9). This is approximately half the peak pressure multiplied by the duration of the positive phase. Peak pressure represents a measure of the maximum force exerted against a surface by a blast wave, since force is equal to the product of pressure and area. Impulse represents a measure of the force multiplied by the duration.

(4) As the shock front moves outward, the peak pressure decreases and the duration of the positive pressure phase increases. The rates of these changes vary with the magnitude of the peak pressure, but the net effect is decrease in impulse. With increase in distance from the bomb, impulse decreases approximately as the reciprocal of the radius.

(5) In general, two criteria must be satisfied in order to demolish any structure. Both peak pressure and impulse must exceed certain minimum values which depend upon the type of structure. Window glass requires a moderately high peak pressure but only a low impulse value since the positive pressure need not last long to cause fracture. On the other hand, a brick wall withstands only a small peak pressure, but the pressure must be of relatively long duration and therefore the impulse value must be high. The blast from almost any charge that develops sufficient peak pressure will have sufficient impulse to break glass. Most bomb charges that develop sufficient impulse to demolish a brick wall also develop sufficient peak pressure to do so. A general rule is that structures that are strong and light in weight, with respect to the area presented to the shock front, require high peak pressure but no great impulse for demolition. Heavy but relatively weak structures require considerable impulse but not such a high peak pressure.

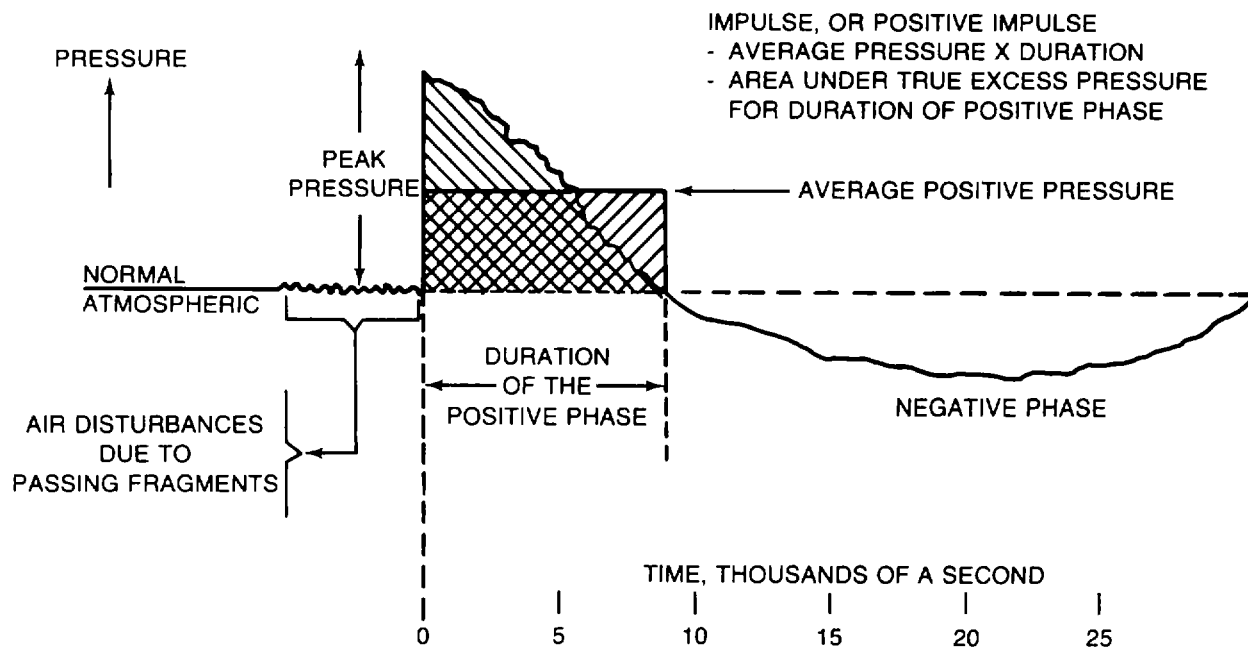

Figure 4-9. Typical pressure-time record for the blast from a bomb.

(6) Blast waves are reflected from solid surfaces but not in the same manner as sound and light waves are reflected. When the incident and reflected waves intersect on the ground, they do not make equal angles with the ground as do sound waves. Refer to figure 4-10. At small angles of incidence (the angle between the normal to the blast front and the normal to the reflecting surface), the angle of reflection is smaller than the angle of incidence, and the pressure behind the reflected wave is greater than behind the incident wave. Such reflection of a blast wave from a bomb that has detonated above the ground gives rise to an increased pressure wave at ground level. When the angle of incidence (α) is greater than an extreme angle (α_e) (40 degrees for strong to a value approaching 90 degrees for very weak shocks), the incident and reflected waves do not intersect on the ground. This is known as irregular or Mach reflection. Reflection that occurs when the angle of incidence occurs at the extreme angle is known as the extreme regular reflection, whereas, reflection occurring where the angle of incidence is smaller than the extreme is known as regular reflection. When the incident angle exceeds the extreme angle, the reflected and incident waves intersect at some point above the ground. The lower portion of the reflected and the incident waves fuse into one wave which is known as the Mach stem (M, figure 4-10), the point of intersection being known as the triple point (TP, figure 4-10). The resulting existence of three waves, termed the Mach reflection, causes a density discontinuity and a region of high pressure termed the Mach region is formed. The pressure behind the front of the Mach region is approximately twice that of the incident wave. The top of this high-pressure region, the triple point, travels away from the reflecting surface. As pressure and impulse appear to have their maximum values just above and below the triple point, respectively, the region of maximum blast effect is approximately that of the triple point. The region of maximum blast effect is determined by the height above the ground at which the blast occurs. At distances that are large compared to the height of the burst, the incident and reflected waves have fused and proceed outward as a single shock. After the point of complete fusion of the waves, the shock wave is the same as one produced by a double charge detonated on the ground. As the distance from point of the blast increases, the Mach stem becomes normal to the ground.

(7) Blast effects are enhanced by confinement due to the reflection of blast waves by the confining surfaces. A blast wave traveling through a tunnel, corridor, trench, or even a street decreases in intensity much more slowly than in the open.

If a bomb detonates within a building, there is considerable reflection of the blast wave from the walls, even if they are demolished. The rapid reflection of the wave from various walls, in such a case, results in a multiple punch effect on another wall. The overall effect of confinement is increased in the vulnerable radius of demolition of the bomb charge. The analogous vulnerable radius of visible damage (as detected by aerial observation) is also used to evaluate the effects of bombing.

b. *Blast Effects Underground.* An explosive charge, if detonated while buried, exerts pressure on the surrounding earth and causes movement effects over a distance known as radius of rupture. If the depth of burial is less than the radius of rupture, the explosion products blow through the surface of the ground and form a roughly circular depression known as a crater. An explosion on the surface of the ground makes a shallow crater which may be a greater diameter than that produced when the explosive is buried. This is due to the scouring action of gases projected downward from the explosive charge. Important factors in crater formation are the type of earth cratered and the type of explosive used. Explosives of a moderate charge in swampy ground make a relatively huge crater, while in a rock formation only a small crater will be formed. An explosive of low detonation rate that produces a large volume of gases, may form a larger crater than TNT if the charge is well below the surface and the ground is not too hard or rocky. If the charge is on the surface, a low-rate explosion makes a smaller crater than TNT because of the weaker scouring action of the lower velocity gases. If an explosive is buried at a depth exceeding the radius of rupture, the compression effect downward and horizontally and the lifting with subsequent subsidence cause a depression on the surface known as a camouflet.

c. *Blast Effects Under Water.* The detonation of high explosive under water results in shock waves of extremely high pressure which decay rapidly with distance from the charge. Since the total damage is due to both the shock wave and the subsequent bubble pulses, these effects must be separately evaluated. One measurement to make is that of the periods of oscillation of the bubble, that is, the time intervals between successive minima in the bubble radius. The length of the bubble period is related to the energy left after passage of the shock wave. In general, the longer the bubble period the greater the energy. A second measure of the energy may be obtained from a study of the maximum and minimum radii of the bubble. By a combination of radius and period measurements, energy calculations can be made.

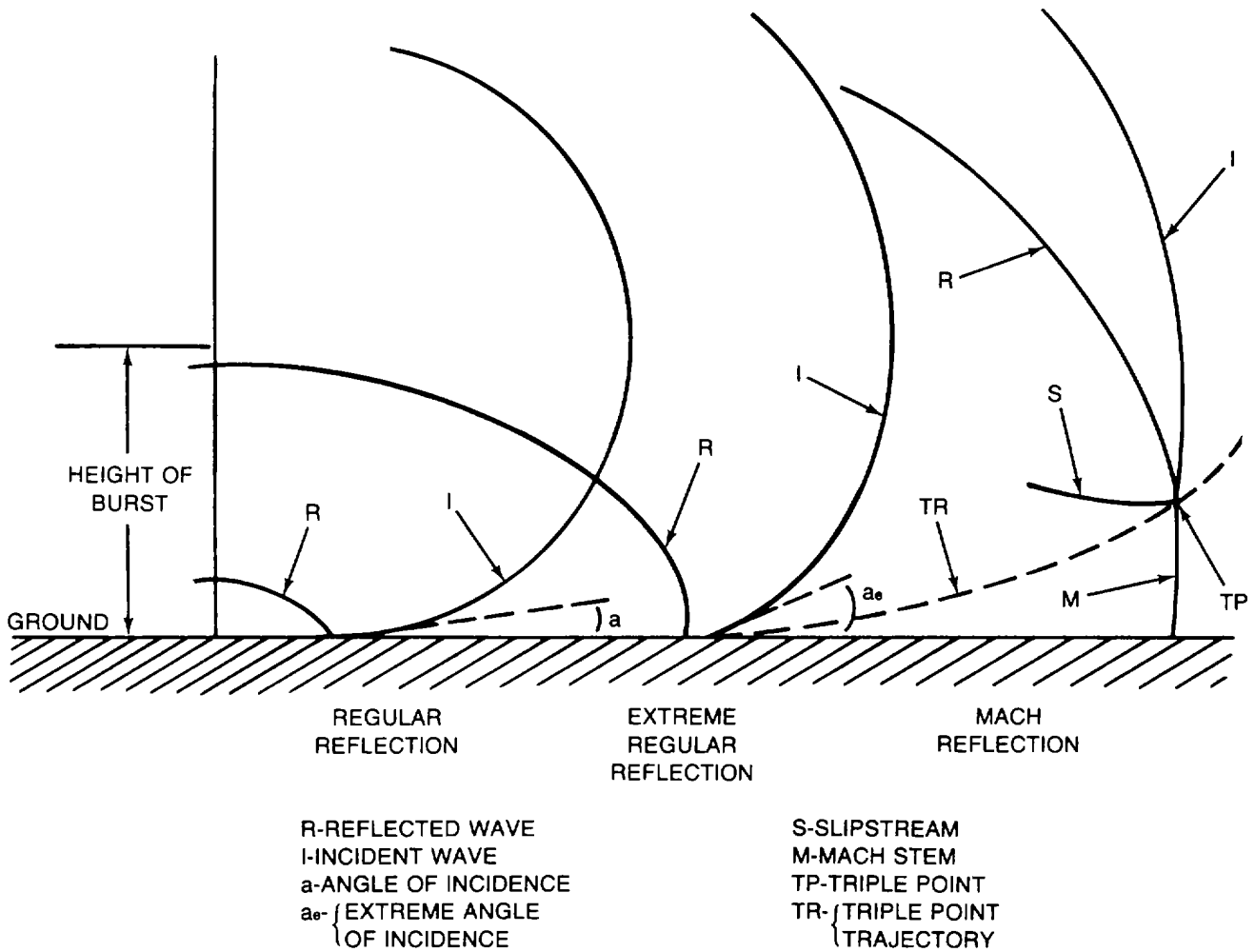

Figure 4-10. Mach reflection of blast wave.

4-7. Shaped Charge Effect. A shaped charge (figure 4-11) is a cylindrical explosive charge with a lined conical cavity in one end. The explosive is generally pressed or cast. The higher the detonation velocity and CJ pressure the more effective the shaped charge is.

Very little effect is produced by explosives having rates of detonation less than 5,000 meters per second. The liner focuses the energy of detonation, thus enabling penetration of very thick and very hard targets such as armor.

a. As the charge explodes, the detonation wave passes over the liner. The liner material is accelerated somewhat normal to the explosive-liner interface (figure 4-12). Nearer the apex of the cone, the liner mass to charge ratio is lower so the velocity the liner material attains is higher. Also, nearer the apex of the cone, the metal liner does not have to distort as much as further down. This also causes the velocity to be higher toward the apex. When the liner material converges at the center line, or axis, of the charge, the surface material is squeezed out at high velocity. This material forms the jet. Since the material closest to the apex is at a higher velocity, the portion of the jet which comes from that area is also highest in velocity. Therefore, the jet has a velocity gradient. The material in the leading tip is moving faster than the material toward the rear. The remaining material, which is the bulk of the liner, forms a heavy slug which follows the jet at a much lower velocity. After traveling a distance of about five or six diameters of the original charge, the jet begins to break up because of the velocity gradient and inhomogenities in the charge and liner. Inhomogenities in the charge and liner cause the jet particles to have slightly different directions of flight.

b. The pressure applied by a shaped charge to a target is to the order of several megabars. This is well into the plastic range for almost all materials. Figure 4-13 illustrates the response of the target material to a shaped charge jet.

Penetration occurs as the target material flows out of the hole. The material dislodged in the deeper parts of the hole flows out along the walls. Penetration is affected greatly by the distance of the base of the shaped charge to the target. This is called stand-off and is usually expressed in charge diameters. There is an optimum stand-off distance for maximum penetration. At closer distances, the jet has not fully formed and at further distances the jet is breaking up, causing the particles to hit off center such that they do not contribute to penetration. Generally the optimum stand-off is between two and six charge diameters. Penetration is normally around four to six diameters but could go as high as 11 to 12 diameters. The optimum liner thickness is about three percent of the charge diameter for soft copper. If a different material is used, the thickness should be determined by measuring the weight of soft copper that would be used for the particular charge diameter. This amount of material is then used. Liners made of less dense material will be thicker than the copper counterpart and liners made of more dense material will be thinner. Materials which are commonly used include copper, steel, glass, and aluminum. The angle of the cone apex varies from 42 degrees to 60 degrees in American ammunition and 18 degrees to 90 degrees in foreign ammunition. Forty-two degrees is the optimum angle for maximum penetration.

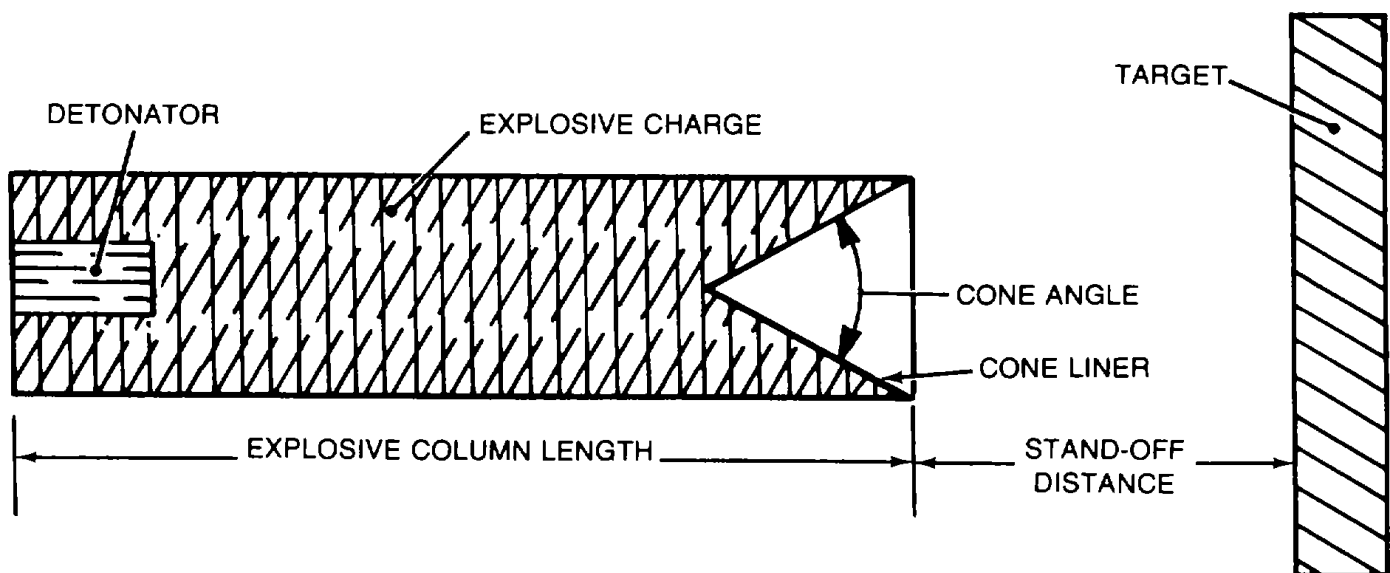
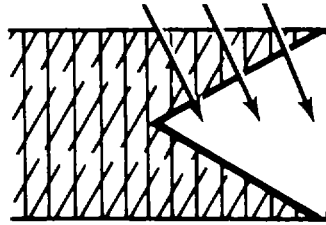
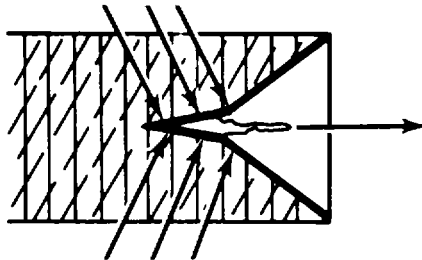

Figure 4-11. Shaped charge and target.



A. LINER IS ACCELERATED NORMAL TO EXPLOSIVE-LINER INTERFACE



B. MATERIAL IS SQUEEZED OUT TO FORM THE JET

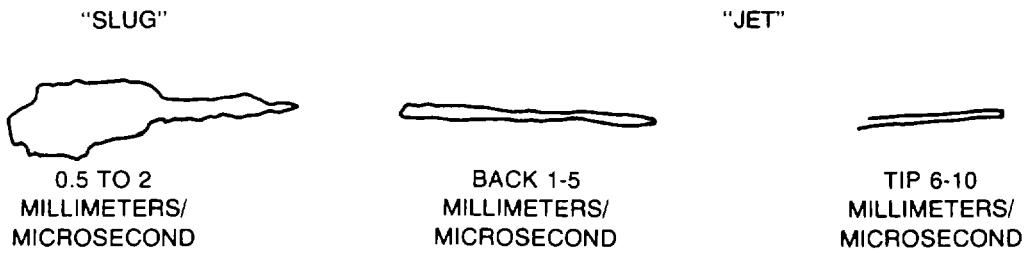

C. SHAPED CHARGE JET

Figure 4-12. Shaped charge jet formation.

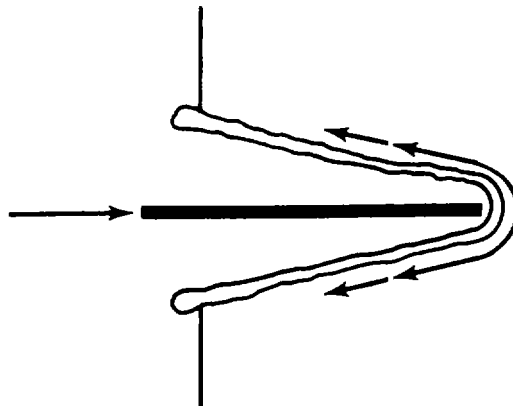

Figure 4-13. Shaped charge penetration.

c. When used in projectiles that rotate, shaped charge penetration is considerably reduced. Projectiles that have conical liners may lose as much as 50 percent of their effectiveness due to rotation. In general, penetration is reduced as spin increases from about zero to 200 revolutions per second, after which further increases have little effect. Rotating shaped charges produces holes of greater diameter than static charges, but rotation does not affect the volume of the hole produced. Changing the apex angle of the cone does not eliminate the reduction in penetration caused by rotation of the charge.

d. The United States uses one other geometry of shaped charge liner, hemispherical. A hemispherical liner produces comparable jet energies to a coneshaped liner. However, the velocity and mass distribution in the jet are different. Hemispherical liners turn inside out with almost all of the material projected in the jet. As much as 70 to 80 percent of the material in conical liner stays behind to form the slug. In hemispherical shaped charges, however, jet velocity is only about half of that obtained in a conical shaped charge. Hemispherical shaped charges are less sensitive to rotation than conical shaped charges.

4-17 (4-18 blank)

CHAPTER 5

PROPERTIES AND TESTS OF EXPLOSIVES

5-1. General Requirements of Explosives for Military Applications.

a. *General.* Numerous compounds are explosive, however the number of compounds that can be used militarily is relatively small. This chapter describes the tests used to cull the usable explosives from the many that are unusable. Many explosive items are designed for a minimum lifespan of ten years. These tests are designed to characterize the explosive as much as possible before deployment to avoid problems during the user phase. The types of tests performed on each explosive depend, to a large degree, on the intended use of the explosive. Most of the tests yield data which are used to rank explosives relative to a standard explosive. The relative rank is then used to determine possible applications. Few tests have absolute ranges that explosives must fall into before use in military items is permitted.

b. *Availability and Cost.* In view of the enormous quantity demands of modern warfare, explosives must be produced from cheap raw materials that are nonstrategic and available in great quantity. In addition, manufacturing operations must be reasonably simple, cheap, and safe.

c. *Sensitivity.* A military explosive must be capable of being detonated and yet be as insensitive as possible. Military requirements for sensitivity are strict. Many compounds that detonate are not used as military explosives because of unfavorable sensitivity characteristics.

d. *Brisance and Power.* The brisance and power of an explosive determine applicability for specific purposes. A bursting charge must be brisant, but a ditching charge needs to be powerful and less brisant.

e. *Stability.* Military explosives must be able to withstand long periods of storage under unfavorable conditions. Storage conditions range from extreme heat and humidity in the tropics to the cold of arctic regions.

f. *Density.* The fixed volume available in a round of ammunition necessitates using explosives of maximum energy density. In general, the greater the density of the explosive the greater the energy available.

This is not true, however, for some of the metalloorganic primary explosives. The high density of these compounds is caused by the presence of mercury or lead which does not add to energy content.

g. *Hygroscopicity.* Hygroscopicity, the property of absorbing moisture, can have an adverse effect on the sensitivity, stability, or reactivity of some explosives. Explosives which are hygroscopic must be loaded in moisture-proof containers. This extra precaution is generally undesirable, so explosives which are nonhygroscopic are used. Ammonium nitrate is an exception. Although very hygroscopic, the compound is extremely cheap and readily available.

h. *Volatility.* Volatility can cause loss by evaporation, development of pressure in rounds of ammunition, and separation of ingredients in composite explosives. These undesirable characteristics must be minimized in military explosives.

i. *Reactivity.* A military explosive must be as nonreactive as possible with the materials used in construction of munitions. Compatibility of specific explosives with these materials is discussed in Chapter 8. The reactions, which are accelerated by moisture in many cases, can cause liberation of gaseous products, loss of power, and loss of sensitivity. In some cases, such as with an azide and copper, the metallic salt formed can be dangerously sensitive. When the explosive is to be loaded in contact with or mixed with another explosive or binder, reactivity between the ingredients must be minimized.

j. *Toxicity.* Minimum toxicity is a desirable quality for any military explosive. A discussion of the toxicity of the explosives of military interest is presented in Chapter 12.

k. *Environmental Impact.* The impact of manufacturing and loading operations on the environment must be as small as possible.

l. *Demilitarization.* A military explosive should have favorable demilitarization characteristics. An example is plastic bonded explosives in which a thermally sensitive binder is used. Upon heating, the binder decomposes and the explosive may be totally recovered for reloading.

m. *Vulnerability and Safety During Use.* Explosives must be as invulnerable as possible to conditions that will be encountered during use. The explosives must also be as safe as possible during both manufacture and use.

5-2. Vacuum Stability Test. This test can be made at 100°, 120°, or 150°C or any other desired temperature, but a temperature of 100° or 120°C generally is employed. A weighed 1 or 5-gram sample of the dried explosive is placed in a glass heating tube, so designed that the ground neck can be sealed with mercury after a calibrated capillary tube with a ground stopper end has been connected to the heating tube (figure 5-1). The lower end of the capillary tube is attached to a cup in which about seven milliliters of mercury are placed after the connection of the two tubes has been made. The system is evacuated until the pressure is reduced to about five millimeters of mercury. The level of the mercury in the capillary tube rises to near the top and its exact position is marked and recorded. The junction of the two tubes is sealed with mercury. The heating tube is inserted in a constant temperature bath maintained at the desired temperature $\pm 0.5^\circ\text{C}$. If an excessive amount of gas (11 + milliliters) is not evolved in less time, heating is continued for 40 or 48 hours. The tube is removed from the bath and cooled to room temperature and the level to which the mercury in the capillary tube has fallen is noted. The volume of gas liberated is calculated from the difference between the initial and final levels, the volume of the capillary per unit of length, the volume of the heating tube, and the atmospheric pressure and temperature conditions at the beginning and end of the test. Vacuum stability test yields reproducible values and when an explosive is subjected to this test at two or more temperatures, a rather complete picture of its chemical stability is obtainable. In some cases, tests at two or more temperatures are required to bring out significant differences in stability between explosives, but a test at 100°C is sufficient to establish the order of stability of an explosive. Vacuum stability test has been found suitable for determining the reactivity of explosives with each other or nonexplosive materials. This is accomplished by making a vacuum stability test of the mixture and determining if the gas liberated is significantly greater than the sum of the volumes liberated by the two materials when tested separately. When used for this purpose, the test generally is made at 100°C.

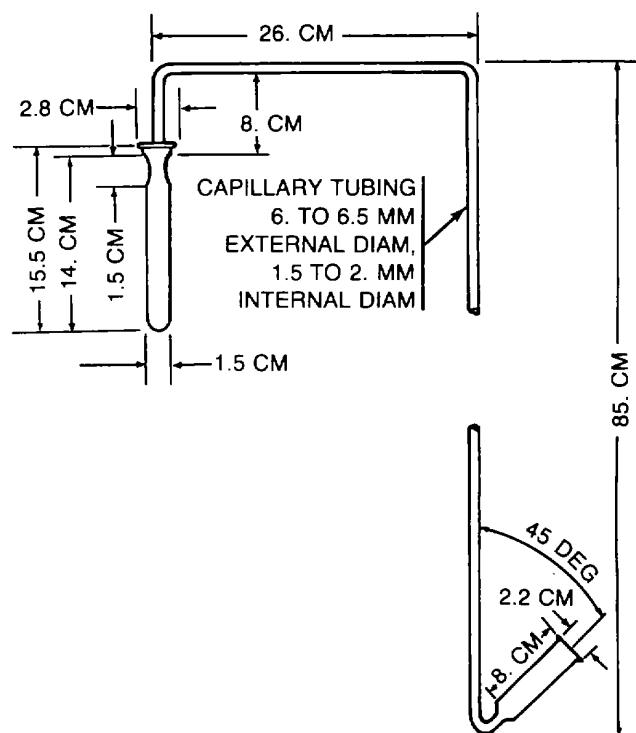

Figure 5-1. Vacuum stability test.

5-3. Impact Sensitivity. There are several different impact sensitivity machines in use. One type, the Explosive Research Laboratory (ERL) machine is shown in figures 5-2 and 5-3. The Picatinny Arsenal apparatus is shown in figures 5-4 and 5-5. The Bureau of Mines apparatus is shown in figure 5-6. The following discussion is relevant to the Bureau of Mines and Picatinny Arsenal apparatus. Sensitivity to impact is expressed as the minimum height of fall of a given weight required to cause at least one explosion in 10 trials, or the minimum height of fall of a given weight to cause explosions in 50 percent of the trials. In such tests, the explosive is ground so as to pass through a No. 50 sieve and be retained on a No. 100 sieve. In carrying out the test with the Picatinny apparatus, a steel die cup is filled with the explosive, covered with a brass cover, surmounted with a steel vented plug, placed in a positioned anvil, and subjected to the impact of a weight falling from a predetermined height. The minimum height, in inches, required for explosion is found after repeated trials. In making the test with the Bureau of Mines apparatus, 0.02 gram of the sample is spread uniformly on a hard steel block, over a circular area one centimeter in diameter. A hard steel tip of that diameter, imbedded in a

steel plunger, is lowered so as to rest on the explosive and turned gently so as to ensure uniform distribution and compression of the explosive. The plunger then is subjected to the impact of a weight falling from a predetermined height. When the minimum height required for explosion is found after repeated trials, this is expressed in centimeters. The Picatinny apparatus can be used for testing explosives having a very wide range of sensitivity, but the Bureau of Mines apparatus cannot cause the explosion of the most insensitive explosives and can be used only for testing explosives no less sensitive than TNT. The Picatinny apparatus can be used for testing solid or liquid explosives. The test with the Bureau of Mines apparatus can be modified so as to be applicable to liquid explosives. This is accomplished by using 0.007 to 0.002 gram (one drop) of the explosive absorbed in a disk of dry filter paper 9.5 millimeters in diameter.

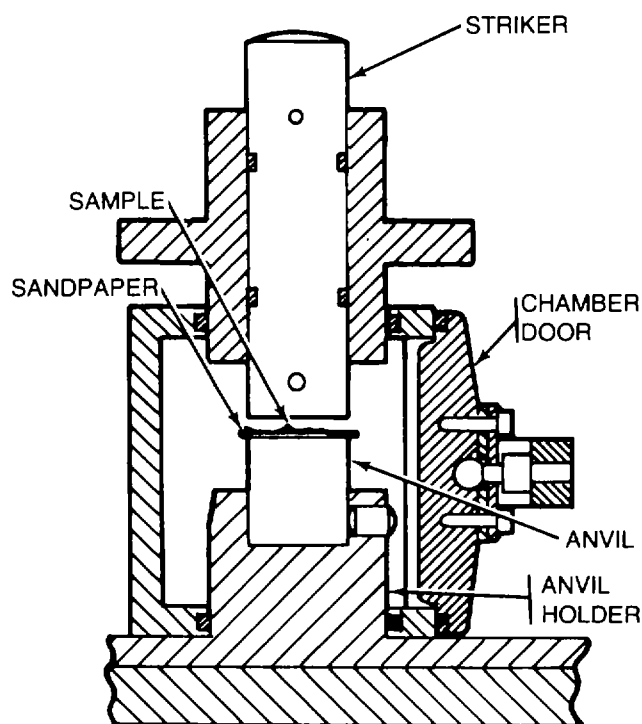

Figure 5-2. Anvil striker arrangement, ERL machine.

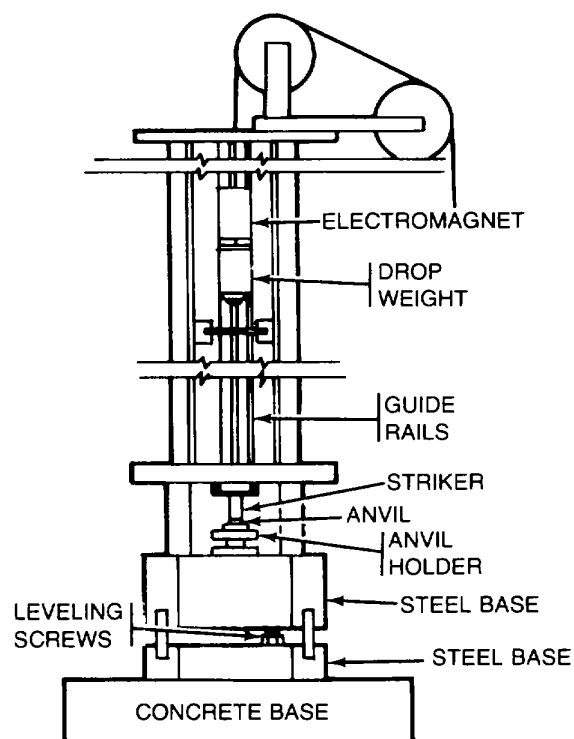

Figure 5-3. Drop weight impact machine, ERL type, type 12 tools.

5-4. Electrostatic Sensitivity. At the present time more than one method is used to determine electrostatic sensitivity. In all of the methods a spark gap is formed between an electrode and the explosive sample. A capacitor is charged to a specific voltage then discharged through the gap. Both the size of the capacitor and the voltage are varied to vary the energy in the spark. Compounds which deflagrate or detonate at spark energy levels less than 0.25 joules are not acceptable.

5-5. Detonation Velocity. Detonation velocity can be determined in any of several ways; the choice of a method probably depends more on the availability of equipment and well tested procedures than on any inherent advantage of a given method.

a. *Chronographic Method.* The chronographic method is widely used. This method depends on the closing of switches either by the conduction of hot gases between two electrodes or by the forcing together of two electrodes by the pressure induced by the detonation. Precision of the measurements depends on the number of switches or pins that is used on the charge and on the precision of the equipment.

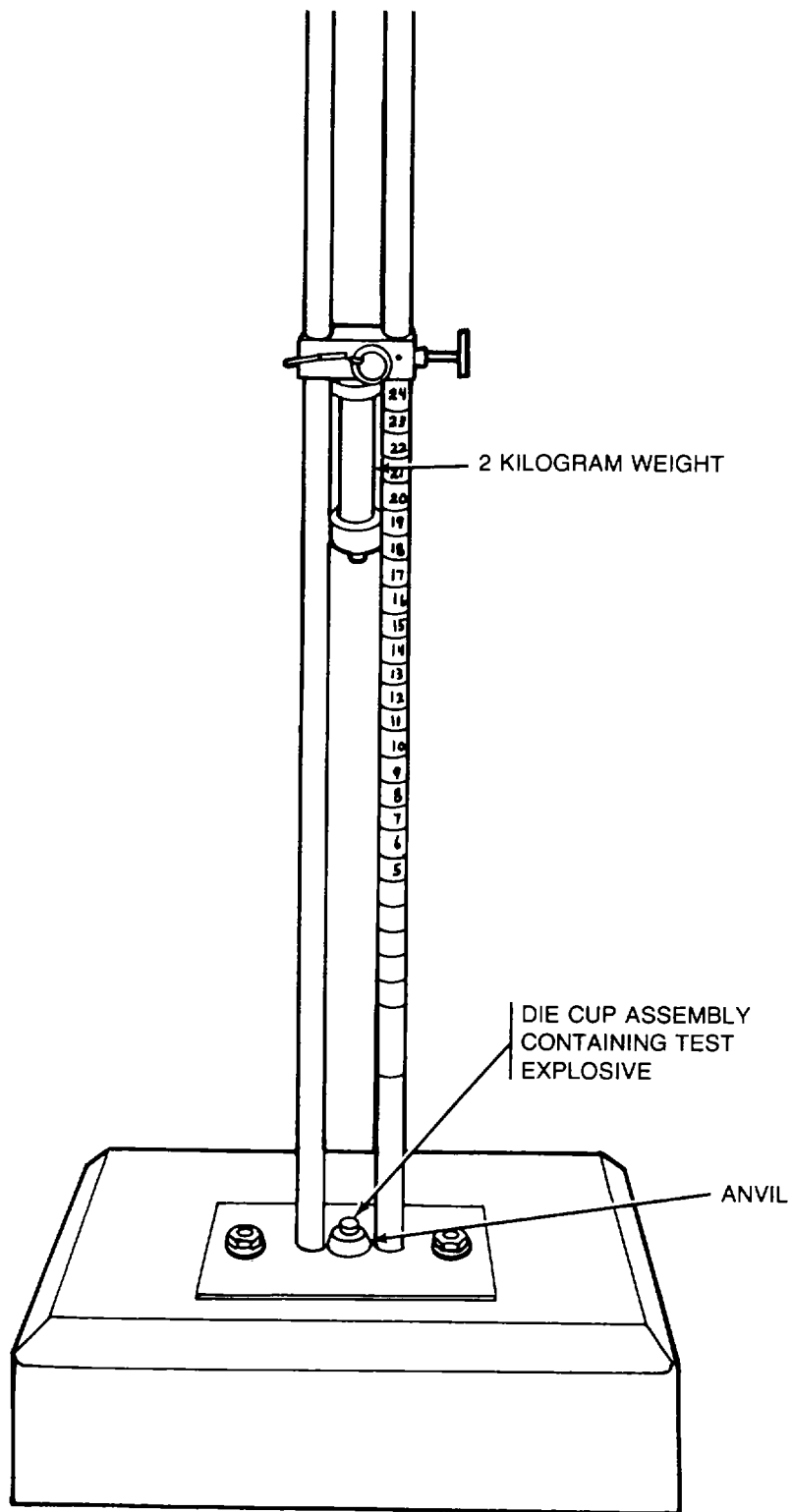

Figure 5-4. Picatinny Arsenal impact test apparatus.

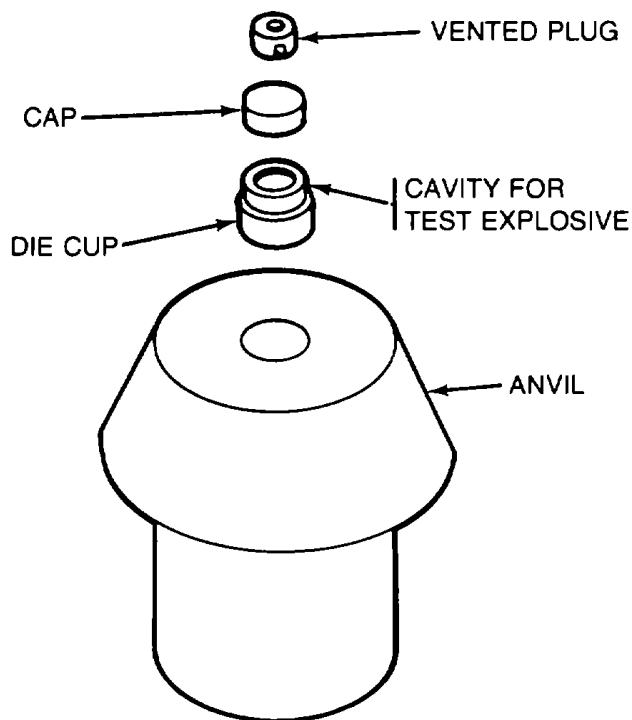

Figure 5-5. Parts of Picatinny Arsenal test apparatus.

b. *Electronic Method.* Another method, which is also entirely electronic, depends on embedding a resistance wire in the explosive. A constant current is maintained in the resistance wire and the return path, which may be a nearby embedded copper wire, a wire or foil on the surface of the charge, or a metal case if the charge is confined. The voltage across the resistance wire is recorded on an oscilloscope. This voltage decreases as the detonation moves along the wire and effectively shortens the wire. This method gives, in effect, the instantaneous position of the detonation front so that the slope of the trace on the record from the oscilloscope is proportional to the detonation velocity. A closely related technique uses a resistance wire which is wound on an insulated wire or other conducting core.

These methods are not recommended for pressed charges. The precision of either version of the resistance technique depends on the quality of the charges, the precision of making the probes, and the precision of the electronics. For smaller diameter charges, the probes and wires may perturb the detonation front so that a true value of the detonation velocity cannot be obtained.

c. *Optical Method.* A commonly used optical method makes use of the streak or smear camera to record the instantaneous position of the detonation front. Because the record gives the instantaneous location of the detonation front, the slope of the streak is proportional to the velocity. Simple data reduction techniques can be used for the application discussed here. The traces are straight so that after digitizing, the data are fitted with a linear relation, the coefficient of the time being the velocity of the detonation. Again, this method can be made to give precise results if sufficient care is taken in preparing the charges and in arranging the experiment.

5-6. Cook-Off Temperature. To determine the cook-off temperature, a sample of approximately five milligrams is placed on a melting point bar. The cook-off temperature is the lowest bar temperature at which the sample flashes off.

5-7. Friction Sensitivity. Friction sensitivity tests are made to determine the relative safety of an explosive during processing. The test may be run on any of several types of machines. In the Picatinny apparatus, a 20 kilogram shoe with an interchangeable face of steel or fiber is attached to a pendulum. The shoe is permitted to fall from a height of one meter and sweep back and forth across a grooved steel friction anvil. The pendulum is adjusted to pass across the friction anvil 18+1 times before coming to rest when no explosive is present. A seven gram sample of the explosive is then spread evenly in and about the grooved portion of the friction anvil, and the shoe is allowed to sweep back and forth over the anvil until it comes to rest. Tests of 10 portions of the sample are made, and the number of snaps, cracklings, ignitions, and/or explosions is noted. As the steel shoe is the more effective in causing explosions, tests with the fiber shoe sometimes will show differences between explosives indicated by the steel shoe to be of the same degree of sensitivity.

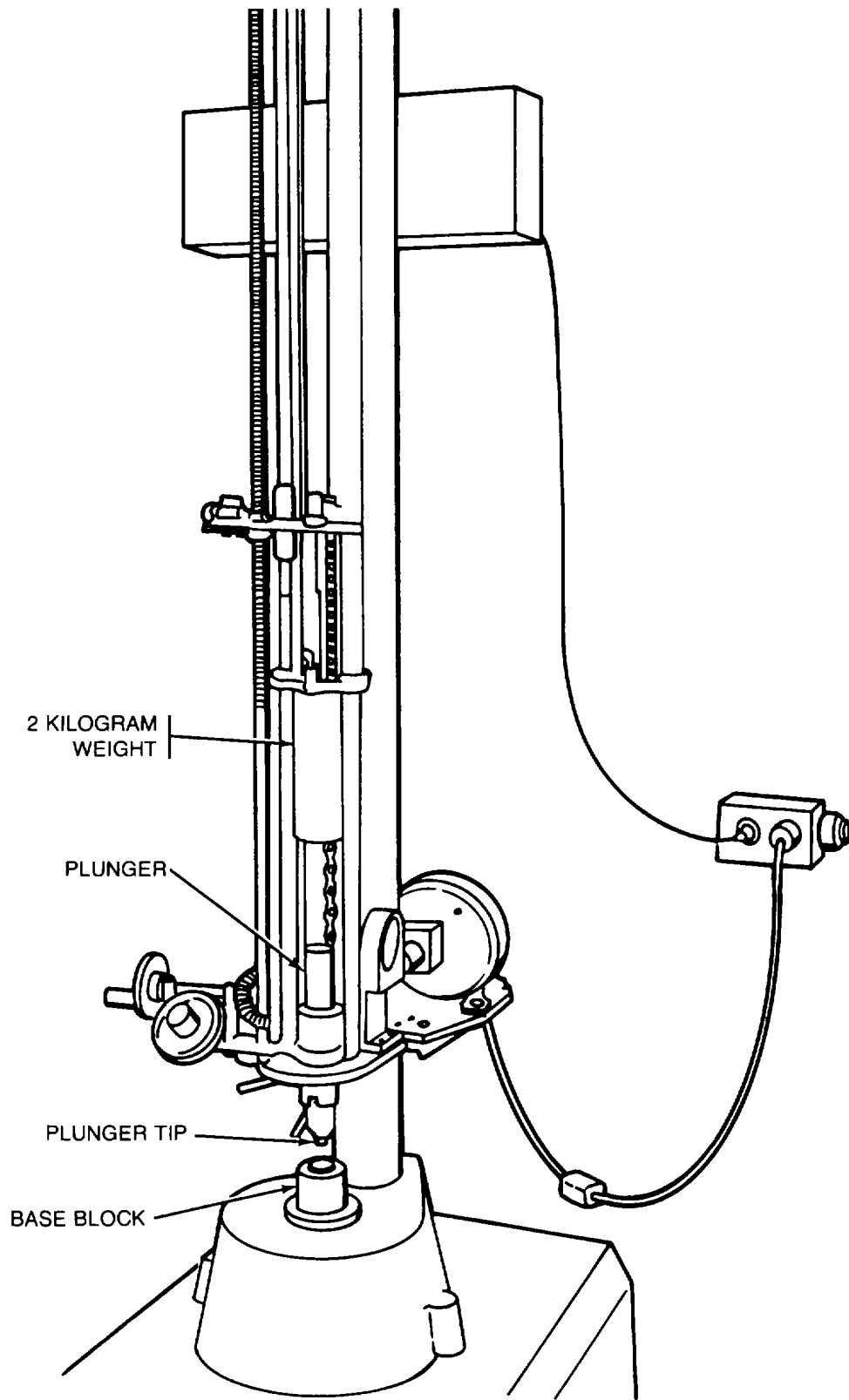

Figure 5-6. Bureau of Mines impact test apparatus.

5-8. Gap Tests. The gap test is used to measure the sensitivity of an explosive material to shock. The test results are reported as the thickness of an inert spacer material that has a 50 percent probability of allowing detonation when placed between the test explosive and a standard detonating charge. In general, the larger the spacer gap, the more shock-sensitive is the explosive under test. The values, however, depend on test size and geometry and on the sample (the particular lot, its method of preparation, its density, and percent voids). Gap test results, therefore, are only approximate indications of relative shock sensitivity. Tests have been developed covering a wide range of sensitivities for solid and liquid explosives at Los Alamos National Laboratory (LANL), Naval Surface Weapons Center (NSWC), Mason & Hanger-Silas Mason Co., Inc., Pantex Plant (PX), and Stanford Research Institute (SRI). The test configurations are briefly described below. In all cases, detonation of the acceptor charge is ascertained by the dent produced in a "witness plate." While there are many more potential gap test geometries, these are the test configurations for which results are reported in this manual.

a. NSWC Small Scale Gap Test (SSGT).

Donor	25.4 millimeters (1 inch) outer diameter x 38.1 millimeters (1.5 inches) long RDX pellet.
Acceptor	25.4 millimeters (1 inch) outer diameter x 38.1 millimeters (1.5 inches) long.
Spacer	25.4 millimeters (1 inch) diameter Lucite disks of different thicknesses.

Results are reported in millimeters.

b. LANL Small Scale Gap Test (SSGT).

Donor	Modified SE-1 detonator with PBX-9407 pellet 7.62 millimeter diameter x 5.26 millimeters long (0.0300 inch x 0.207 inch).
Acceptor	12.7 millimeters diameter x 38.1 millimeters long (0.5 inch x 1.5 inches).
Spacer	Brass shims in 2.5 millimeter (0.1 inch) increments.

Results are reported in millimeters.

c. LANL Large Scale Gap Test (LSGT).

Donor	41.3 millimeters diameter x 102 millimeters long (1.625 x 4 inches) PBX-9205 pellet.
-------	--

Acceptor	41.3 millimeters diameter x 102 millimeters long (1.625 x 4 inches).
Spacer	41.3 millimeters diameter (1.625 inches) disks of 2020-T4 Dural (aluminum).

Results are reported in millimeters.

d. PX Gap Test.

Donor	25.4 millimeters diameter x 38.1 millimeters long (1 inch x 1.5 inches) LX04 pellet.
Acceptor	25.4 millimeters x 25.4 millimeters (1 x 1 inch) right cylinder.
Spacer	25.4 millimeter (1 inch) diameter brass shims in 0.25 millimeter (0.1 inch) increments.

Results are reported in millimeters.

5-9. Flying Plate Test. The flying plate test is used to measure the vulnerability of an explosive to high velocity impact. A steel plate is propelled by the detonation of an explosive at the sample under test. The velocity of the plate is adjusted by varying the size of the explosive charge.

5-10. Transportation Vibration. This test is performed on an end item to determine if the explosive is satisfactory for that specific application. The test consists of vibrating explosive components according to a specified schedule of frequencies, amplitudes, and durations while being maintained under prescribed temperate conditions.

5-11. Temperature and Humidity. This test consists of exposing end items containing explosives to conditions of cycling temperature and humidity.

5-12. Jolt. In this test an end item containing explosives is attached to the end of a pivoted arm. The arm is raised to a prescribed height and allowed to drop freely. The end item strikes a leather padded anvil. The test is repeated a prescribed number of times with the end item in a number of different orientations to the anvil.

5-13. Jumble. In this test an end item containing explosives is placed in a wood lined steel box. The box is then rotated about two diagonal corners at a speed of 30 revolutions per minute. The rotation is continued for 3,600 revolutions.

5-14. Forty Foot Drop Test. In this test, explosive components, such as bombs, are dropped 12.2 meters (40 feet) onto a hard impact surface. The impact surface consists of a steel plate on a concrete pad. The impact area is surrounded by walls of sufficient height and strength to contain the component during rebound. The component is dropped a number of times so different areas of the item are exposed to the impact. This test is used to determine the safety of both the component case and the contained explosive. No cracks, breaks, deformation, or displacement should occur in the component case. No explosion, burning, or charring of the explosive should occur.

5-15. Growth and Exudation Characteristics.

When explosives contain liquids as impurities, they often undergo irreversible dimensional changes when subjected to many temperature cycles between 54°C and + 71°C. In explosives containing TNT, the dinitrotoluenes form low-melting liquid eutectics which cause problems. Mononitrotoluenes added as anti-cracking agents give large irreversible growth in TNT explosives. In the use of pure TNT explosives, one solution to the cracking problem is the use of pure TNT with addition of high melting point eutectic formers which reduce cracking without introducing objectionable irreversible dimensional change during the normal temperature variations encountered. Another cause for irreversible dimensional change is the solid polymorphic transition such as occurs with ammonium nitrate. (Refer to ammonium nitrate in Chapter 8.) Procedures for solids include measuring any cylindrical sample at least 1.27 centimeters in diameter by 1.27 centimeters in height, temperature cycled between -54°C and +60°C for 30 cycles or more. If no exudation or excessive growth is noted, an additional test can be made for exudation by placing two cylinders together inside a sealed can. These should be held together by parallel steel face plates and clamped together at an initial pressure of 413.7 kilopascals. The sealed unit is subjected to 30 cycles from ambient to 140°F, maintaining each temperature long enough for the entire sample to reach the temperature of the oven. The sample is then observed for exudation. Any exudate is removed and weighed.

5-16. Rifle Bullet Impact Test. Rifle bullet impact tests may use a .30 or .50 caliber bullet. Results reported in this manual use a .30 caliber bullet. In the .30 caliber test a bomb is prepared by screwing a closing cap to one end of a piece of cast iron pipe 7.62 centimeters long, 5.08 centimeters in diameter, and threaded at

both ends. The bomb is filled with the cast, pressed, or liquid explosive and is closed by screwing on a closing cap. With the loaded bomb in a vertical position, a caliber .30 bullet is fired through it from a distance of 30 yards, so that the bullet strikes between the two closing caps and at a right angle to the axis of the bomb. Five or more such tests are made and the percentage of explosions is noted. Those explosives which do not detonate, deflagrate, or burn are considered highly desirable. Those which burn but do not detonate are still generally satisfactory, but those which detonate are used only in applications where detonation from projectile impact is unlikely because of protection, high altitude release, or other considerations.

5-17. SUSAN Test. The SUSAN Sensitivity Test is a projectile impact test. The projectile head contains about 0.45 kilograms of explosive and the target is armor-plate steel. Figure 5-7 shows the projectile used in this test. The results of the tests are expressed as a sensitivity curve in which the relative point-source detonation energy released by the explosive on impact is plotted as a function of the projectile velocity. The relative point-source detonation energy can be derived from a transit-time measurement of the air shock from the point of impact to a pressure gauge three meters (10 feet) from the point of impact. The results determined in this manner are somewhat subjective, particularly when the reaction level shows a large but relatively slow increase with time. The currently preferred way to determine the point-source detonation energy is to relate it to the overpressure measured by the pressure gauge. This method gives much more reproducible data and is not subject to many of the errors of the transit-time measurements. On the figures in Chapter 8, the energy scale ranges from zero (no chemical reaction) to about 100 for the most violent detonation-like reactions (all explosive consumed). Less violent burning reactions that appear to consume all of the explosive can give values as low as 40, whereas the energy equivalent of TNT fully reacted as a point source would be 70. In the test material of Chapter 8 details of the impact process pertinent to the impact safety of an explosive are given. Remarks about probabilities of large reactions are relevant to unconfined charges in the 11 kilogram (25 pound) class. Smaller unconfined charges show a trend of decreasing reaction level as the charge size decreases. References to the "pinch" stage of impact refer to the terminal stage of the test when the nose cap has completely split open longitudinally and has peeled back to the steel projectile body, which is rapidly brought to a halt.

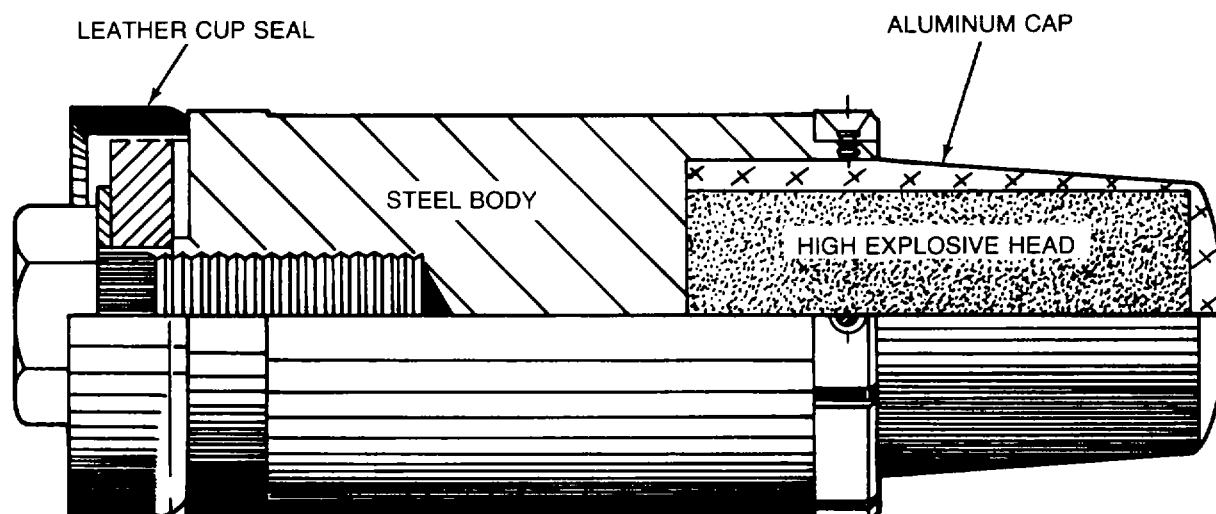

Figure 5-7. Scaled drawing of the SUSAN projectile. The high explosive head is 4 in. long and 2 in. in diameter (102 m x0.051 m).

5-18. Skid Tests. A combination of friction and impact is a frequent cause of accidents where large pieces of an explosive can be dropped a few feet. The skid test measures the sensitivity of an explosive material hitting a rigid surface at glancing angle. In one testing configuration a sample of the explosive is dropped vertically onto a hard surface inclined at 45 degrees. In another testing configuration the explosive sample is attached to the end of a pendulum. The pendulum is allowed to swing from a predetermined height.

5-19. Adiabatic Sensitivity Test. In the adiabatic sensitivity test a sample of the explosive is placed in an airtight holder. The top of the holder has an air compressing piston that decreases the volume and thus increases the pressure in the test chamber when struck by a falling weight. The results of the test are reported as the height the weight must fall, thus the degree of compression, to produce detonation in 50 percent of the cases.

5-20. Fragmentation Test. In the fragmentation test a charge of the explosive under test is loaded into a cylinder or artillery shell and detonated in a pit filled with sand or sawdust. The fragments are separated magnetically and categorized by weight. This test also gives an indication of the brisance of the explosive.

5-21. Cylinder Expansion Test.

a. An important problem faced by the designer of fragmentation warheads is that he must maximize the energy which is transferred from explosive to metal during the detonation. The most frequently encountered configuration is that of an explosive-filled metal cylinder detonated by a wave moving axially. The best scaling law that has been devised for this condition is that of Gurney, who disregarded detonation conditions and shock effects in the metal and assumed implicitly that all the energy of the explosive is conserved. His equation for the cylinders is

$$v = \sqrt{2E \left(\frac{C/M}{1 + 0.5 C/M} \right)}$$

where v is the velocity to which the metal is accelerated by the explosive, E is unit energy content of the explosive, C is the weight of the explosive, and M is the metal weight. This expression of velocity in terms of C/M implies that weight-ratio scaling of explosive and metal is of prime importance and that dimensional scaling need not be considered at all. The term $2E$ has the dimensions of a velocity as was pointed out by Gurney in his original report.

b. Determination of the Gurney constant of a warhead explosive is made in the cylinder expansion test where the explosive contained in a metal cylinder is end-detonated and the maximum lateral velocity of the metal is measured. The geometry resembles that of most fragmentation warheads, particularly as to lateral confinement of the explosive. The dimensions of the cylinder can be chosen so as to give the full run-up to detonation velocity before reaching the location of fragment velocity measurements, and the end-release effects can be kept far enough downstream so as not to affect fragment velocities. Other techniques for evaluating explosives, while of full value in their own contexts, are all less applicable to the prediction of effects in the fragmentation warhead. The plate-push test transfers only about one-fourth as much of the energy of the explosive to the metal as does the cylinder expansion; also, the air cushion between explosive and plate is highly unrepresentative of the warhead configuration. Other rating tests such as the plate dent, ballistic mortar, and the Trauzl lead block are even more unrepresentative geometrically.

c. The cylinder expansion test is any test performed where a metal cylinder (relatively thin walled) is loaded with an explosive and this explosive charge is detonated. As the detonation occurs, the expansion of the cylinder wall is observed and recorded in such a way that the rate at which the wall moves outward can be followed up to the point where the expanding cylinder wall is obscured by the reaction products as they break through the wall.

d. The method for observing the wall's expansion varies. It has been recorded through the use of electronic pin probes and raster oscilloscope recording systems as well as with flash X-ray techniques. It has also been accomplished by the use of streak cameras and framing cameras. The Lawrence Radiation Laboratory method uses a streak camera for the recording of the wall velocity and a pin probe method for determining the detonation velocity of the explosive while it is expanding the walls of the test cylinder. The Atomic Weapons Research Establishment, UK, uses both electronic pin probe and streak camera methods to record the wall expansion, and pin probes for the detonation velocity. There is some reason to believe that, perhaps in the early stages of the expansion, the pin probe method may be more accurate, but the data reduction is also a bit more difficult in some respects than with the streak camera record.

e. When various explosives are rated in the standard geometry, the relative performance of these explosives becomes readily apparent. This permits the warhead design engineer to select an explosive compound for a specific feature of its performance.

f. It has been demonstrated that cylinder expansion test results scale up or down over a wide range of sizes.

CHAPTER 6

PROPERTIES AND TESTS OF PROPELLANTS

6-1. Introduction. The tests performed on propellants can be divided into three classes: mandatory, prescribed, and optional. The mandatory tests, covered in paragraphs 6-2 through 6-13, are safety tests. These tests must be run on each propellant formulation. The prescribed tests, covered in paragraphs 6-14 through 6-17, provide useful information about a propellant formulation. These tests are generally run on propellant formulations after the mandatory tests. The optional tests, covered in paragraphs 6-18 through 6-23, are only run if warranted by the intended application of the propellant formulation. Tests in which a propellant formulation is heated are called accelerated aging tests.

6-2. Compatibility. Compatibility can be measured by any of three methods: Taliani test, vacuum stability test, and differential thermal analysis. The propellant and the inert material being tested for compatibility are mixed together in some ratio which may vary from equal parts of propellant and test material to 10 parts propellant and 1 part inert material. In the vacuum stability test, increased reactivity is indicated by the mixture evolving more than five milliliters of gas over the sum of the amount of gas produced by the ingredients tested separately. In a differential thermal analysis, increased reactivity is indicated by an upward displacement of the curve. In the Taliani test, increased gas production also indicates more reactivity. Increased reactivity is considered evidence of incompatibility.

6-3. External Heat. In this test, also called the bonfire test, the propellant formulation is loaded into a standard cartridge assembly or storage container. The sample is mounted 30.5 centimeters (one foot) above a fire which is allowed to burn for 30 minutes. The test is recorded using a 16 millimeter movie camera. The film record of the test is examined to determine if any detonation occurred. No detonation reaction is considered the acceptable criteria for a propellant formulation.

6-4. Deflagration to Detonation Transition. In this test, an igniter is placed in the bottom of a tall test container which is then filled with the sample material. Propellants must not undergo detonation when ignited in this manner.

6-5. Heat Tests. Heat tests are performed at 1 34.5°C for single-base propellants and 1 20°C for double-and triple-base propellants. These tests measure the stability of the propellant. Specimens of the propellant are placed into the bottom five centimeters (two inches) of a glass test tube. A piece of methyl violet indicator paper is placed vertically in the tube so that the lower end of the paper is 25 millimeters from the specimen. The tube is corked and set into a constant temperature block or a constant temperature reflux bath. The temperature must be maintained to within 0.5°C. The result of the test is reported as the time required for the test paper to change color to salmon pink. For the propellant to pass the test, the color change cannot occur in less than 40 minutes or 60 minutes, depending on the propellant formulation, and the sample may not explode in less than five hours.

6-6. Vacuum Stability. Vacuum stability tests are performed at 100°C for single-base propellants and 90°C for double-and triple-base propellants. This test determines propellant stability on the basis of the volume of gas liberated on heating the propellant under vacuum. The propellant specimen is placed in a heating tube which is then connected to a capillary tube. Mercury is placed in a cup on the other end of the capillary tube. The system is then evacuated to approximately five millimeters. The mercury is then allowed to enter the capillary. The heating tube is then placed in a constant temperature reflux bath. The volume of gas liberated during the test is determined by observing the mercury level. If rate data is desired, the volume of gas is observed at regular intervals. If the volume of condensable gases is desired, the volume of gas is calculated based on measurements before the tube is removed from the constant temperature bath. Although there is no specific pass-fail criteria established for this test, the test is stopped when the gas volume reaches 11 +mil.

6-7. Closed Bomb. The standard closed bomb is a thick-walled cylindrical vessel capable of withstanding gun pressures. The bomb is equipped with firing electrodes to affect ignition, a pressure transducer, a gas release valve, a thermocouple, and temperature controlled water jacket. The result of the test is a pressure time plot. There is no pass-fail criteria for this test.

6-8. Surveillance. In the surveillance test, a 45 gram sample of the propellant is placed in a 237 milliliter (eight ounce) glass, stoppered bottle which provides an essentially airtight seal. The bottle consists of a special colorless resistance glass which has no more than 0.02 percent alkalinity calculated as potassium hydroxide. The test is performed at 65.5°C. The bottle and contents are placed in a chamber and the temperature is regulated to within one degree centigrade. After 24 hours of heating, the stopper is reseated. Daily observations are then made to check for the appearance of reddish fumes which indicate the presence of oxides of nitrogen. Single-base propellants, when new, should last for fifteen hundred days before fuming. Double-base propellants should last at least 400 days. This test does not yield reliable data for triple-base propellants. For these propellants, the stabilizer content is analyzed at regular time intervals. The rate of stabilizer depletion gives an indication of the maximum storage life of the propellant. A stabilizer depletion test can also be performed on single-and double-base propellants.

6-9. Card Gap. The card gap test measures the sensitivity of a propellant formulation to detonation by a shock wave. A sample of the propellant is placed in a cardboard tube with a booster explosive. The explosive and sample are separated by a series of 0.254 millimeter (0.01 inch) cellulose acetate cards. The test results are reported as the number of cards necessary to prevent detonation of the sample. Three successive trials with no detonation are required. Seventy cards represent the dividing line between an explosive and fire hazard material.

6-10. Cap. This test determines whether a propellant formulation can be detonated by a shortened number eight blasting cap. The sample and blasting cap are placed on top of a lead cylinder. Whether a detonation occurs is determined by the degree of compression of the cylinder. The test results are reported as either a detonation, sample burned, sample fragmented but no reaction, or no reaction. To pass this test, the propellant must not detonate.

6-11. Electrostatic Discharge Sensitivity. This test determines the sensitivity of a propellant formulation to energy from an electrostatic discharge. A test sample of not more than 50 milligrams is placed on a test plate. A capacitor is charged to the desired energy level with a 5,000 volt power source and discharged into the sample through a steel needle. Results are reported as the maximum energy which can be applied without decomposing the sample. Twenty consecutive negative results are required at the specified energy level.

High sensitivity material yields results in the range of 0.001 to 0.00875 joules, medium sensitivity material in the range of 0.00875 to 0.0125 joules, and low sensitivity material in the range of 0.0125 to 12.5 joules.

6-12. Friction Sensitivity. This test is performed on an apparatus which consists of a metal sliding block, a stationary metal wheel that is attached to a hydraulic ram, and a weighted pendulum. The sample, amounting to no more than 50 milligrams, is placed on the block under the wheel. Pressure is applied using the hydraulic ram. The pendulum is raised to a 90 degree position and dropped. Results are reported as the maximum force which can be applied to the wheel without causing the sample to decompose. Normally, 20 consecutive negative results must be obtained. The results of this test are compared to those obtained for other propellants. Most standard propellants have values of about 4,360 Newtons.

6-13. Impact Sensitivity. This test may be performed on any of the standard impact sensitivity devices. The results of the test are compared with data obtained for other standard propellants.

6-14. High Loading Rate Compression. In this test, propellant grains are subject to compressive loading at about the same rate and in the same time frame as occurs in the chamber during firing. The propellant grains are machined to give flat parallel ends with a length to diameter ratio of approximately one. The machined samples are compressed perpendicular to the flat ends using a high rate hydraulic servo. The servo is computer controlled. The results of the test are the maximum compressive strength, the strain at the maximum compressive strength, stress-strain curves, the time to maximum compressive strength, and whether the mode of failure was brittle or ductile. A drop tower apparatus may also be used to obtain higher strain rates.

6-15. Low Loading Rate Compression. For this test, propellant grains are machined to give flat parallel ends usually with a length to diameter ratio of one. Solid grains are usually extruded to yield a diameter of approximately 1.27 centimeters (0.5 inches). The device used for this test is a mechanically driven, electronically controlled tester capable of continuously recording the load exerted on a test specimen. The compressive effect on the sample is also measured. The result of the test is a load-displacement curve. From this curve the strain at maximum compressive strength and maximum stress are computed.

6-16. Taliani. The Taliani test is used to determine the stability of a propellant. A dry sample of the propellant is placed in a tube, heated to a specified temperature (usually 110°C), and the tube is evacuated. The composition of the atmosphere above the sample is controlled by alternately filling with nitrogen or another gas and evacuating a specified number of times. The pressure is then reduced and heating is continued. The pressure in the tube is measured with a manometer. The increase in pressure as the test progresses is a measure of the rate of decomposition of the sample. The test result is a graph of the time versus the pressure in the tube. The following data is usually reported: the time in minutes required for the pressure to reach 100 millimeters of mercury, the slope of the line at 100 millimeters of mercury, and the slope of the line at 100 minutes.

6-17. Explosion Temperature. In this test, a sample of the propellant formulation is loaded into a gilding metal tube and then immersed in a woods metal bath which has been raised to a specified temperature. The time to ignition is recorded. Ignition is detected by noise, flash, or smoke. The ignition time is obtained at several temperatures. A time-temperature plot is made. The result that is reported, the temperature required to ignite the propellant in five seconds, is obtained by extrapolation of the time-temperature plot.

6-18. Strand Burner. In this test a strand of propellant that is 17.8 centimeters (seven inches) long and 3.2 millimeters (one-eighth of an inch) in diameter is placed in a bomb in which the temperature and pressure can be regulated. The strand is placed vertically in a jig and ignited at the top. Vertical burning is ensured by coating the strand with a compound that does not interfere with the burning of the propellant. Two wires are inserted through the jig, one 6.4 millimeters (one-quarter of an inch) from the top of the strand and the other 12.7 centimeters (five inches) below the first. As the propellant burns, an electronic circuit through the two wires is broken and an automatic timer is used to determine the burning time. The rate is calculated from the strand length and burning time. The effect of initial temperature and pressure on the burning rate is measured.

6-19. 90°C Dutch Weight Loss Test. In this test, a four gram sample of a propellant is placed in a stoppered tube and inserted in a heating block which is maintained at 90°C. Every second day the stoppered tube is removed and cooled to room temperature for 30 minutes. The stopper is then briefly lifted and closed again. The tube is weighed to the nearest milligram and reinserted in the heating block. The test results are then plotted as weight loss percentage versus the time in days, as shown in figure 6-1. The initial bump in the curve, which results from loss of volatiles, is ignored. The results reported are the number of days coinciding with the kink in the curve, which indicates the onset of instability.

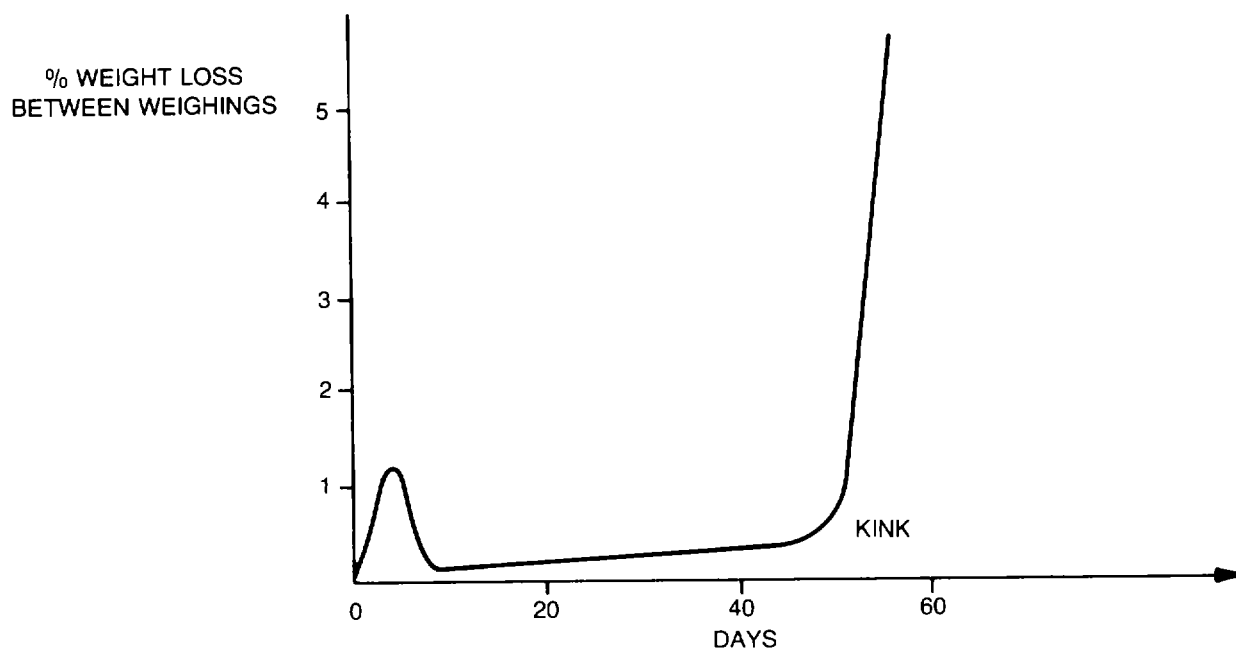

Figure 6-1. 90°C Dutch weight loss test results.

6-20. Shaped Charge Jet Impact. This is a vulnerability test. The propellant is loaded into a standard cartridge. The cartridge is placed behind a 1.27 centimeter (one-half inch) steel plate. A shaped charge jet is fired through the steel plate directly at the cartridge. Video tape and film are used to record the reaction of the propellant in the cartridge. The results are compared to the results for other propellants.

6-21. Shaped Charge Jet Spall. This is a vulnerability test. The propellant is loaded into a standard cartridge. The cartridge is placed behind a 1.27 centimeter (one-half inch) steel plate. A shaped charge is aligned so that the jet does not impact the cartridge shell when fired through the plate, but the spall from the plate does. Video tape and film are used to record the reaction of the propellant in the cartridge.

6-22. Single Fragment Impact. This is a vulnerability test. The propellant is loaded into a standard cartridge. Standard .50 caliber 208 grain fragments are fired into the cartridge at a velocity of about 1,585 meters per second (5,200 feet per second). The velocity of the fragments before impact is recorded and video tape and film are used to record the reaction of the propellant in the cartridge.

6-23. Multiple Fragment Impact. This is a vulnerability test. The propellant is loaded into a standard cartridge. Fragments are explosively launched at a velocity of about 2,286 meters per second (7,500 feet per second) in a pattern such that each cartridge is impacted by at least two fragments. The velocity of the fragments before impact is recorded and video tape and film are used to record the reaction of the propellant in the cartridge.

CHAPTER 7
UNITED STATES PRIMARY EXPLOSIVES

7-1. Introduction. This chapter contains discussions of military primary explosives. The chemical, physical, thermochemical, sensitivity, performance, and stability characteristics of each explosive are covered. The method of manufacture is also given. If known, the chemical structure of each compound is shown. This chapter also contains a discussion of priming compositions.

7-2. Lead Azide.

a. Lead azide, $Pb(N_3)_2$, is a salt of hydrazoic acid, HN_3 . The compound is white, has a nitrogen content of 28.86 percent and a molecular weight of 291.26. At the melting point, 245°C to 250°C, decomposition into lead and nitrogen gas occurs. The pure compound has two crystal modifications: an orthorhombic form and a monoclinic form. The orthorhombic form, which is also called the alpha form, has a density of 4.68 grams per cubic centimeter and unit cell dimensions of $a = 11.31$ Angstroms, $b = 16.25$ Angstroms, and $c = 6.63$ Angstroms. The monoclinic form, which is also called the beta form, has a density of 4.87 grams per cubic centimeter and unit cell dimensions of $a = 18.49$ Angstroms, $b = 8.84$ Angstroms, and $c = 5.12$ Angstroms. The compound is usually prepared as colorless, needlelike crystals.

The orthorhombic form is very sensitive. During manufacture, the production of this crystal form must be avoided. Lead azide is soluble in acetic acid and almost insoluble in ether, acetone, alcohol, ammonia, or organic solvents. In water the solubility is 0.02 percent at 18°C and 0.09 percent at 70°C. Lead azide may be dissolved in monoethanolamine or in a 50/50 mixture of monoethanolamine/ammonia. Recovery can be accomplished by adding dilute acetic acid, but the product obtained will be impure. The heat of formation at constant pressure is -112 to -126.3 kilocalories per mole. The calculated heat of detonation is 0.367 kilocalories per gram. Lead azide is used extensively as an ingredient in initiating compositions.

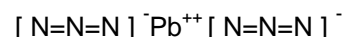

Figure 7-1. Structural formula for lead azide.

b. The forms of lead azide used for military purposes include the following types. Table 7-1 compares the properties of the types of lead azide.

Table 7-1. Various Types of Lead Azide

Properties	DLA (type I, US)	SLA	CLA (type II, US)	PVA-LA (US)	RD-1333	DCLA
Color	Buff	White	White	White to buff		
Lead azide, percent	92.7	98.1	99.9	96.0	98.7	95.3
Total lead, percent	69.3	71.5	71.67	71.6	71.06	69.99
Particle size, mean, microns	24.5	55.0	3.4	19.0	34.5	1.74
Apparent density in grams per cubic centimeter	1.83	-	0.85	-	-	-
Density, pressed at 103,425 kilopascals, (15,000 psi) in grams per cubic centimeter	3.14	3.31	-	3.81	-	-
Sand test values	13.8	-	15.0	-		

Table 7-1. Various Types of Lead Azide (Continued).

Properties	DLA (type I, US)	SLA	CLA (type II, US)	PVA-LA (US) buff	RD-1333	DCLA
Five second explosion temperature	340	350	344	340	345	-
Impact sensitivity Picatinny Arsenal apparatus with 2 kilogram weight, in inches	4-6	2	2-3	4-5	5	3-6
Charge weight in milligrams Bureau of Mines apparatus with 2 kilogram weight in centimeters	28	37	25	30	23	18
Picatinny Arsenal apparatus with 500 gram weight in inches	13-28	30	-	13-16	15	-
Charge weight in milligrams Bureau of Mines apparatus with 500 gram weight in centimeters	12	-	6	18	15	-
Minimum charge in milligrams required to initiate 60 milligrams of RDX in an M47 detonator	28	-	-	31	21	-
Vacuum stability in milliliters per gram 100° C, gas evolved 120 °C, gas evolved	100 +	-	35	100 +	100 +	-
100°C Heat test: Loss in sample wt in 8 hrs, /o	90	25	-	30	25	-
Loss in sample wt in 48 hrs, %	0.32	-	-	0.20	-	-
Loss in sample wt in 96 hrs, %	0.46	-	-	0.44	0.43	-
Explosion in 100 hrs	-	0.11	0.12	0.30	-	-
Hygroscopicity at room temperature and 90% relative humidity for 56 hours	0.34	0.08	-	0.13	0.30	-
	0.39	0.16	-	-	0.30	-
	None	None	-	None	None	-
	1.18	0.07	0.02	0.03	-	-

(1) Dextrinated Lead Azide (DLA) is also known as type I lead azide. Dextrin is used as a colloid agent which prevents the formation of large, sensitive crystals and regulates crystal shape during manufacture.

(2) Service Lead Azide (SLA) consists of lead azide crystals each containing a nucleus of lead carbonate. This form of lead azide is used extensively in the United Kingdom. The method of manufacture of this compound is confidential. SLA is practically nonhygroscopic and is superior to DLA in functioning characteristics. Storage under water is considered hazardous due to the possibility of growth of the crystals and formation of agglomerates which detonate spontaneously. Other long term storage tests dispute this result.

(3) Colloidal Lead Azide (CLA) is also known as type II lead azide. CLA is nondextrinated lead azide of very small particle size. The size of the particles is in the range of three to four microns. CLA is not suited for uses requiring good flow characteristics, but, because of the very fine particle size, is ideal as a spot charge and a priming charge in low energy, electric initiators. CLA successfully replaced the milled DLA formerly used for this purpose, thus eliminating the milling operation which was always considered dangerous, even under carefully controlled conditions. In preparing a spot charge for a low energy, electric detonator, dry CLA is mixed with a concentrated solution of nitrocellulose in ether, alcohol, or other organic solvent, and a small quantity of the resulting paste is placed on the bridgewire to form a droplet called a spot. For a type of detonator in which the bridgewire is located inside a cavity, the charge of CLA can be made in the form of a pellet by pressing wet CLA into the cavity.

(4) Polyvinylalcohol Lead Azide (PVA-LA) consists of lead azide crystals coated with polyvinylalcohol. PVA-LA possesses practically the same sensitivity to impact as DLA, but is much more efficient in detonators and is practically nonhygroscopic. The ignitability is about the same as for straight lead azide and better than for DLA. The normal lead azide content is 93 to 96 percent. Other substances, such as polyethylene glycols and ureaformaldehyde polymer, can be used to produce mixtures with properties very similar to PVA-LA.

(5) RD-1333 lead azide is an insensitive form of lead azide. The method of manufacture as well as some properties of RD-1333 are confidential.

(6) Dextrinated Colloidal Lead Azide (DCLA) is essentially DLA with a very small particle size. The particle size is in the range of one to two microns.

c. In the manufacture of DLA two stock solutions must be prepared. Solution A is prepared by dissolving about 73.9 kilograms (169 pounds) of lead nitrate in about 750 liters of water treated by the permutit demineralization process. Care must be taken to remove all grit and insoluble matter. The pH of this solution is in the range of 4.2 to 4.6. To neutralize this acidity 25 to 30 grams of sodium hydroxide in dilute solution are added. The sodium hydroxide will neutralize the occluded acid and the acid formed by the hydrolysis of the lead nitrate. An excess of sodium nitrate must be avoided to prevent the production of elongated crystals which are very sensitive. About 4.08 kilograms of potato dextrin that was previously dissolved in about 100 liters of water is then added and the solution is brought to 7.325-0.07 percent lead nitrate content. Solution B is prepared by diluting a refined solution of 27 percent sodium azide to 3.175+0.02 percent sodium azide content. Then 794 grams of sodium hydroxide in the form of pellets are added. The sodium hydroxide is added to neutralize most of the free acid formed during the interaction of solutions A and B. This quantity of sodium hydroxide is also just sufficient to control the purity of the finished lead azide by precipitating a small quantity of lead as $Pb(OH)_2$ or $Pb(OH)N_3$. The solution is then adjusted to 3.175 ± 0.025 percent sodium azide content. Solution A is then heated to between 57.5°C and 60°C with agitation and 50 liters of solution B are added at the rate of two liters per minute. The slow rate of mixing these two very dilute solutions inhibits the formation of the orthorhombic crystalline polymorph. After solution B has been added, the temperature is lowered to 90°C or lower with continued agitation. When agitation stops the lead azide settles out. The precipitate is caught on filter cloths under vacuum and washed with four changes of

water to remove the acidity. To manufacture colloidal lead azide, a solution of four percent sodium azide is maintained at 25°C. Then a solution of lead acetate or lead nitrate is added with agitation. The lead nitrate or acetate is in slight excess of the amount required by the equation:

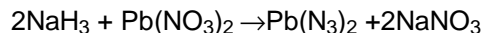

The resulting slurry is then filtered and the precipitate washed with several changes of water and dried.

d. The specifications for dextrinated lead azide, type I, and collodiol lead azide, type II, are:

Properties	Type	
	I	II
Color	White to buff	White to buff
Form, dimension maximum	Free from needle shaped crystal	
Purity, minimum	91.5%	99.0%
Acidity	None	None
Solubility in water, maximum	1.0%	
Particle size geometric mean, micron maximum	-	5
Largest micron maximum	-	10

A needle shaped crystal is defined as a crystal having a length to diameter ratio of 7 to 1 or greater. Needle shaped crystals are more sensitive than crystals of normal shape and tend to detonate under pressure. RD-1333 lead azide must be precipitated from a solution of sodium carboxymethyl cellulose which is used as the crystal growth agent. The color shall be white to buff. The aggregates shall contain no well defined translucent crystals when examined microscopically. The particles shall be opaque and irregular in size and shape and the powder shall be free flowing. RD-1333 lead azide must have a minimum bulk density of 1.1 grams per milliliter, be 98.5 percent pure, have a pH in the range of 7.5 to 5, and have a maximum solubility of one percent in water. In nitric acid, the insoluble material shall be no more than 0.05 percent and none of the material shall be retained on a US standard sieve 230. In addition there shall be no more than trace quantities of iron, copper, chlorides, nitrates, and acetates. Carboxymethyl cellulose may be present in concentrations of 0.6 to 1.20 percent. Another specification for special use lead azide has the same requirements as stated for RD-1333, except there is no limitation for trace quantities of iron, copper, chlorides, nitrates, and acetates.

e. Dextrinated lead azide is less sensitive to impact than mercury fulminate, lead styphnate, diazodinitrophenol, tetracene, or crystalline lead azide. The small aggregates that pass through a No. 325 sieve are slightly less sensitive than those that pass through a No. 230 sieve and are retained on a No. 270 sieve. When wet with water or 95 percent ethanol, lead azide has the comparative sensitivity values shown by table 7-2. The impact test results are from the Picatinny Arsenal apparatus with a two kilogram weight.

Table 7-2. Sensitivity of Dry and Wet Lead Azide

Composition, percent			Impact test inches	Pendulum friction test			
Lead azide	Water	Ethanol		Fiber shoe		Steel shoe	
				Trials	Detonation	Trials	Detonation
100	-	-	4	1	1	-	-
80	20	-	9	10	0	4	1
80	-	20	4	1	1	-	-
75	25	-	9	10	0	12	0

The five second explosion temperature is 315°C to 345°C for pure lead azide and 275°C for dextrinated lead azide. These temperatures are much greater than the corresponding values for mercury fulminate, lead styphnate, diazodinitrophenol, and tetracene and reflect the greater difficulty in igniting lead azide in practical use. The maximum static discharge for which no ignition takes place is 0.01 joules.

f. When subjected to the sand test, dextrinated lead azide is 95 percent as brisant as the pure crystalline material and 40 percent as brisant as TNT. At maximum density, the rate of detonation is 5,400 meters per second. The rate of detonation for samples with densities of 3.8 and 4.6 grams per cubic centimeter are 4,500 and 5,300 meters per second, respectively. Slightly higher values than these have been reported. The temperature developed on detonation is between 3,420°C and 3,484°C and the pressure developed on detonation is 94,930 kilograms per square centimeter. When lead azide detonates, 308 milliliters of gas are evolved per gram of explosive with the lead produced in the gaseous form. Trauzl lead block tests have shown dextrinated lead azide to be 89 percent as powerful as the pure compound but only 80 percent as powerful as mercury fulminate and 40 percent as powerful as TNT.

g. Lead azide is an excellent initiating agent for high explosives. While not superior to mercury fulminate for detonating the less sensitive explosives such as TNT, lead azide is markedly superior as an initiator for the more sensitive explosives such as tetryl, RDX, and PETN. Unlike diazodinitrophenol, lead azide cannot initiate the detonation of ammonium picrate or cast TNT.

h. The stability of dextrinated as well as pure lead azide is exceptional. This is indicated by 100°C heat and vacuum stability tests and also by storage tests. No change is found with respect to purity or brisance after storage for 25 months at 50°C or under a water-ethanol mixture at ordinary temperature. Storage at 80°C for 15 months caused no decrease in brisance and, after such storage, a priming composition containing lead azide showed no decrease in sensitivity to stab action. The beta form is considerably less stable than the alpha form and undergoes decomposition much more rapidly. Low X-ray dosages cause lead azide crystals to decrepitate with heat and increase in hardness. Higher X-ray dosage produces severe damage. Ninety-eight percent destruction of an SLA sample was observed after an X-ray dose of 3.5×10^8 rontgen. Lead azide corrodes copper with the formation of cupric azide. Cupric azide is highly sensitive, so tools of brass, bronze, or copper cannot be used with lead azide. Figure 7-2 shows the DTA curve for lead azide.

7-3. Mercury Fulminate.

a. Mercury fulminate, $\text{Hg}(\text{ONC})_2$, is a salt of fulminic or paracyanic acid. The acid undergoes polymerization very rapidly in both aqueous and ethereal solutions, and so cannot be isolated. The structure of fulminic acid, and thus the salts of this acid, is undetermined. Mercury fulminate has an oxygen balance to CO_2 of -17 percent, an oxygen balance to CO of -5.5 percent, a nitrogen content of 9.85 percent, and a molecular weight of 284.65. When mercury fulminate is crystallized from water, a hydrate, $\text{Hg}(\text{ON: C})_{1/2} \cdot \text{H}_2\text{O}$, is formed that has a nitrogen content of 9.55 percent and a molecular weight of 293.64. The anhydrous form, which is crystallized from alcohol, is white when pure but normal manufacturing yields a gray product of only 98 to 99 percent purity. The crystals formed are octahedral but are usually truncated. Only the smaller crystals are fully developed. The crystal density is 4.43 grams per cubic centimeter. Table 7-3 shows the density of mercury fulminate as a function of loading pressure.

Table 7-3. Loading Density of Mercury Fulminate

Pressure in kilopascals	Pressure in pounds per square inch	Density in grams per cubic centimeter
20,685	3,000	3.0
68,450	10,000	3.6
137,900	20,000	4.0
344,750	50,000	4.3

Pressures of more than 172,375 to 206,850 kilopascals (25,000 to 30,000 pounds per square inch) cause mercury fulminate to be desensitized to the extent of becoming dead pressed. Such material merely ignites and burns when subjected to contact with flame. The dead pressed material can be detonated by a strong blasting cap. If a layer of loose or only slightly pressed mercury fulminate covers the dead pressed material, the ensemble can be detonated by ignition. When the dead pressed material is detonated, the velocity of detonation is greater than for material that has not been dead pressed. Mercury fulminate has a melting point of 160°C, but explodes at that temperature. The solubility in one liter of water is 0.71 grams at 12°C, 1.74 grams at 49°C, and 7.7 grams at 100°C. The solubility in ethanol is slight. Because of these slight solubilities, mercury fulminate can be stored underwater or, if there is danger of freezing, under a mixture of equal volumes of water and ethanol or methanol. After such storage the compound can be dried easily. Aqueous ammonium

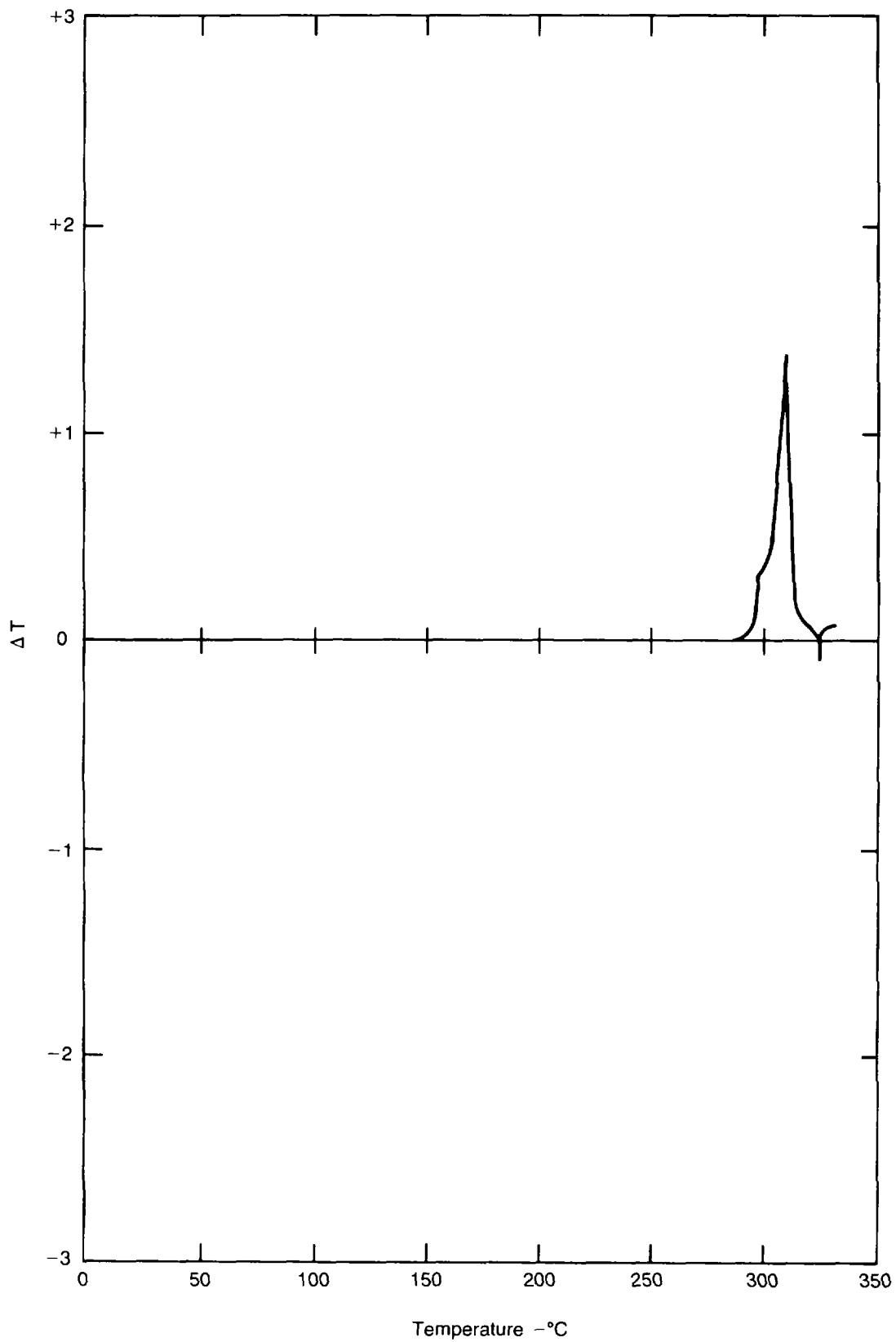
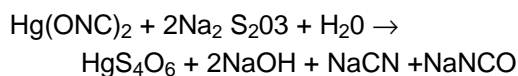

Figure 7-2. DTA curve for lead azide.

hydroxide, aqueous potassium cyanide, and pyridine dissolve mercury fulminate. The compound can be recovered by treating the ammonium or potassium solution with acid and the pyridine solution with water. The heat of formation is 221 to 226 calories per gram, heat of combustion is 938 calories per gram, and the heat of explosion is 427 calories per gram. Mercury fulminate was used extensively as an initiator, however, poor stability has prompted replacement of this compound by such initiators as lead azide.

b. Mercury fulminate reacts with concentrated hydrochloric acid to produce hydroxylamine, $\text{H}_2\text{N.OH}$, and formic acid, HCOOH . The reaction with sodium thiosulfate in aqueous solution forms mercury tetrathionate according to the equation:



If allowed to stand, a secondary reaction occurs with the formation of sulfate and thiocyanate according to the equation:

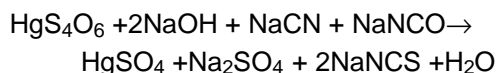

The first reaction can be used for the determination of the purity of mercury fulminate. Even in the presence of 0.5 percent moisture, pure mercury fulminate does not react with any of the common metals. However, the standard grade of the compound may contain as much as one percent free mercury, formed by exposure to light or elevated temperatures. The free mercury readily forms amalgams with copper, brass, or bronze, so components containing these metals must be protectively coated if used with mercury fulminate.

c. Mercury fulminate is manufactured in relatively small quantities. About one pound of redistilled mercury is added to an open, earthenware vessel or five liter flask that contains eight to ten pounds of nitric acid with a specific gravity of 1.4. The nitric acid is in excess of the amount required by the equation:

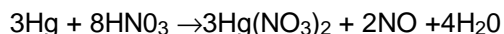

A large number of such charges are usually prepared and allowed to stand overnight until the mercury is completely dissolved. The charges are then poured into a large balloon flask which contains eight to ten pounds of 95 percent ethanol. The flask rests in a bath of running, cold water. This installation has to be either outside or in a building provided with an exhaust system. The flask is fitted with a reflux condenser. About two to three min-

utes after the acidic solution of mercury nitrate is added to the ethanol, a violent reaction starts and the liquid boils with the evolution of white fumes. Most of these fumes are recovered by the condenser. As the reaction approaches the end point, the fumes change color to brownish-red because of the decomposition of nitric acid by heat. A small quantity of dilute alcohol is added at this point to moderate the reaction and prevent the decomposition of the mercury fulminate by the heat of reaction. The reaction normally takes about an hour and a half. The reaction mix is then allowed to cool to room temperature, at which time all the mercury fulminate has settled out. The mercury fulminate crystals are then caught on a screen and washed with cold water until free of acid and five impurities known as fulminate mud. The washed mercury fulminate is then drained and packed into cloth bags which are stored in tanks of water until required for use. The acid mother liquor and the water washings are neutralized with alkali, evaporated to recover the alcohol, and treated to recover any mercury or mercury salts. The yield of the process is 120 to 130 parts per 100 parts of mercury.

d. In the manufacturing process ethyl nitrate ($\text{C}_2\text{H}_5.\text{ONO}_2$), ethyl nitrite ($\text{C}_2\text{H}_5.\text{ONO}$), and nitroethane ($\text{C}_2\text{H}_5\text{NO}_2$) also are produced. The intermediate products of oxidation and nitration involved in the preparation of mercury fulminate are as follows:

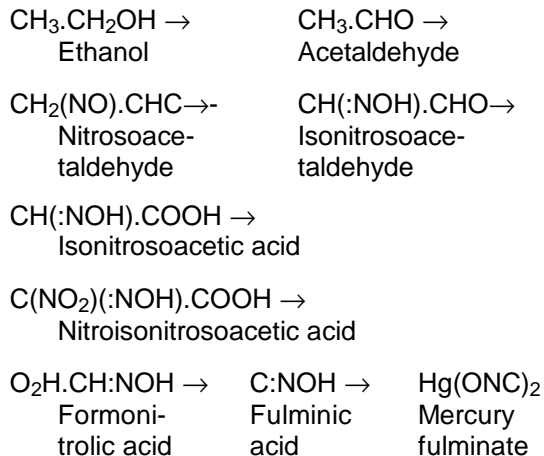

The product so obtained is not more than 99 percent pure. The material can be purified so as to have a fulminate content of 99.75 percent or more by dissolving the impure material in concentrated ammonium hydroxide, filtering the solution, cooling the filtrate, and reprecipitating slowly adding concentrated nitric acid with rapid agitation while keeping the temperature below 35°C . Conditions can be established so that the

precipitated fulminate is of essentially the same granulation as the impure material. The precipitated pure fulminate is washed with distilled water until free of acid. The yield is 80 to 87 percent.

e. Mercury fulminate for military use consists of one grade. The requirements applying are:

Appearance:	Crystals of sparkling appearance that are white, gray, or light gray with a yellowish tint.
Granulation:	A maximum of 15 percent retained on a No. 100 and a maximum of 75 percent passing through a No. 200 sieve.
Sand test:	0.400 gram shall crush a minimum of 44 grams of sand.
Mercury fulminate:	Minimum, 98.0 percent.
Acidity:	None.
Insoluble matter:	Maximum, 2.0 percent.
Free mercury:	Maximum, 1.0 percent.
Chlorine:	Maximum, 0.05 percent.

The chlorine content requirement is due to the occasional use of a small quantity of cupric chloride, CuCl_2 , for the purpose of improving the color of the product. The chloride is added to the solution of mercury in nitric acid. While this improves the color, there is also a decrease in the purity of the product. The insoluble matter represents decomposition products, which are formed as the result of side reactions.

f. The impact sensitivity on the Bureau of Mines apparatus with a 20 milligram sample is five millimeters and on the Picatinny Arsenal apparatus with a nonstandard 2.2 kilogram weight is four inches. This indicates mercury fulminate is more sensitive to impact than lead azide and lead styphnate. Being of the same sensitivity to impact as diazodinitrophenol and tetracene, these three compounds are the most sensitive initiating explosives used in military ammunition. Mercury fulminate is more sensitive to friction than lead azide and lead styphnate, exploding with both the steel and fiber shoe. The five second explosion temperature is 210°C which indicates mercury fulminate is more sensitive to heat than lead azide or lead styphnate, but less sensitive than diazodinitrophenol and tetracene.

The sensitivity of mercury fulminate to percussion is one of the compound's most advantageous characteristics. Mercury fulminate is highly sensitive to electric spark. A spark from a person charged to less than 5,000 volts causes ignition. This condition is possible in plant operations. The sensitivity to electrostatic discharge is reported to be 0.025 to 0.07 joules.

g. The sand test indicates mercury fulminate is 27.3 to 59 percent as brisant as TNT. The rate of detonation of a charge with a density of 2.0, 3.0, and 4.0 grams per cubic centimeter is 3,500, 4,200, and 5,000 meters per second. When ignited, a single crystal will burn rapidly with a flash, but detonation does not take place. When a layer of crystals is ignited, high order detonation takes place. The Trauzl test indicates a power of 37 to 50 percent of TNT. Mercury fulminate is distinctly more powerful than lead azide.

h. Although mercury fulminate is not as efficient an initiator of detonation as lead azide and diazodinitrophenol, satisfactory results are obtained when used in conjunction with tetryl, RDX, or PETN, the most generally used booster explosives. The number of grams of mercury fulminate required for complete detonation of TNT is 0.25 to 0.36, for tetryl is 0.20 to 0.29, for RDX is 0.19, for PETN is 0.17, and for explosive D is 0.85.

i. Mercury fulminate is no longer used by the United States military because of poor stability. The usual stability tests are not applicable to mercury fulminate, due to explosion in a relatively short time at temperatures above 85°C . The products of deterioration are nonexplosive solids rather than gases. When the purity of mercury fulminate is reduced to about 92 percent, the initiating efficiency is destroyed although the material will explode when ignited. When purity has been reduced to 95 percent, the stability of mercury fulminate must be considered seriously impaired. Table 7-4 gives a summary of the approximate times of storage required to cause deterioration to 92 percent and 95 percent. Mercury fulminate gains 0.02 percent when exposed to 90 percent relative humidity at 30°C . When dry, mercury fulminate reacts rapidly with aluminum and magnesium and reacts slowly with copper, zinc, brass, and bronze. When wet, mercury fulminate reacts immediately with aluminum and magnesium and rapidly with copper, zinc, brass, or bronze. Dry or wet, the compound does not effect iron or steel.

Table 7-4. Deterioration of Mercury Fulminate

Storage temperature °c	Time required to reduce purity to					
	95 percent			92 percent		
	Days	Months	Years	Days	Months	Years
80	0.5	-	-	1	-	-
50	-	8	-	-	11	-
30-35	-	-	1.7	-	-	5.8
20	-	-	7	-	-	9
10	-	-	8	-	-	10

7-4. Diazodinitrophenol (DDNP).

a. This explosive is also known as 4,5-dinitrobenzene-2-diazo-1-oxide, dinol, diazol and may be referred to as DADNP. The compound (figure 7-3) is a greenish yellow to brown solid with tabular crystals. DDNP has a crystal density of 1.63 to 1.65 grams per cubic centimeter at 25°C and a molecular weight of 210.108. DDNP is not dead pressed even at a pressure of 896,350 kilopascals (130,000 pounds per square inch). The solubility of DDNP in various solvents is shown in table 7-5.

Table 7-5. Solubility of Diazodinitrophenol

	Solubility, grams per 100 grams of solvent at-	
	25°C	50°C
Water	0.08	-
Benzene	0.09	0.23
Methanol	0.57	1.25
Ethanol	0.84	2.43
Ether	0.04	-
Chloroform	-	0.11
Ethylene chloride	0.29	-
Acetic acid	1.40	-
Ethyl acetate	-	2.45
Acetone	6.0	-

DDNP is also soluble to some extent in nitroglycerin, nitrobenzene, aniline, pyridine, and concentrated hydrochloric acid. DDNP is nearly insoluble in carbon tetrachloride and carbon disulfide. The heat of formation is 956 calories per gram and the heat of explosion is 820 calories per gram. DDNP is used as an ingredient in priming compositions and in commercial blasting caps.

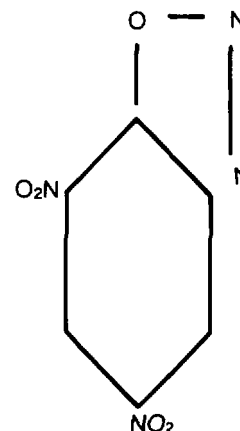

Figure 7-3. Structural formula for DDNP.

b. At ordinary temperatures DDNP does not react with water, but the mixture of the two is less sensitive than DDNP alone. DDNP is darkened rapidly by exposure to sunlight, probably because of oxidation at the surface.

c. The process used commercially for the manufacture of DDNP is not available, but the compound can be prepared by the diazotization of picramic acid by means of sodium nitrite and hydrochloric acid. The reactions involved are shown in figure 7-4. Picramic acid may be prepared by evaporating a mixture of an alcoholic solution of ammonium picrate and ammonium sulfide and purifying the product. Ten grams of picramic acid are suspended in 120 milliliters of a five percent aqueous solution of hydrochloric acid. The mixture is cooled with an ice bath and stirred rapidly. A solution of 3.6 grams of sodium nitrite in 10 milliliters of water is added all at once and stirring is continued for 20 minutes. The dark brown, granular material that separates

is caught on a filter and washed with ice water until the washings give no indication of hydrochloric acid or sodium chloride. If this material is dissolved in hot acetone and a large volume of ice water added to the agitated solution, the DDNP is precipitated as a bright yellow, amorphous powder. Recrystallization from a solvent is used to produce the tabular crystals that comprise specification grade material. After manufacture, the DDNP is kept wet with water until used.

d. Only one grade of DDNP is used for military purposes. This complies with the following requirements:

Color:	Greenish yellow to brown.
Form:	Tabular crystals having a maximum length of 0.2 millimeter.
Granulation:	100 percent shall pass through a No. 100 US standard sieve.
Bulk density:	Minimum, 0.4 grams per milliliter.
Acidity:	Maximum, 0.01 percent as hydrochloric acid.
Sand test:	0.40 gram shall crush not less than 33 grams of sand.

e. DDNP is less sensitive to impact than lead azide or mercury fulminate. The friction sensitivity is approximately the same as lead azide but less than mercury

fulminate. The five second explosion temperature is 195°C. A mixture of DDNP and water is desensitized to the extent that a number eight blasting cap cannot cause detonation. DDNP detonates when struck with a sharp blow. An unconfined sample burns with a flash if ignited but even the slightest confinement causes a transition from burning to detonation. A charge of DDNP undergoes detonation when ignited if pressed into a blasting cap shell with a reinforcing cap and a piece of black powder safety fuse crimped in the shell. A spark falling into the open end of such a blasting cap causes only ignition and flashing of the DDNP. The maximum energy of a static discharge that does not cause ignition is 0.25 joules.

f. The sand test indicates DDNP is 94 to 105 percent as brisant as TNT. DDNP is considerably more brisant than mercury fulminate, lead azide, lead styphnate, and tetrazene. At a density of 1.58 grams per cubic centimeter DDNP and TNT have the same velocity of detonation, 6,900 meters per second. At densities of 0.9 and 1.63 grams per cubic centimeter the detonation velocities are 4,100 and 7,100 meters per second, respectively. The Trauzl test and ballistic mortar test indicate that DDNP is 110 percent and 95 percent as powerful as TNT, respectively. The gas volume produced on detonation is 856 liters per kilograms.

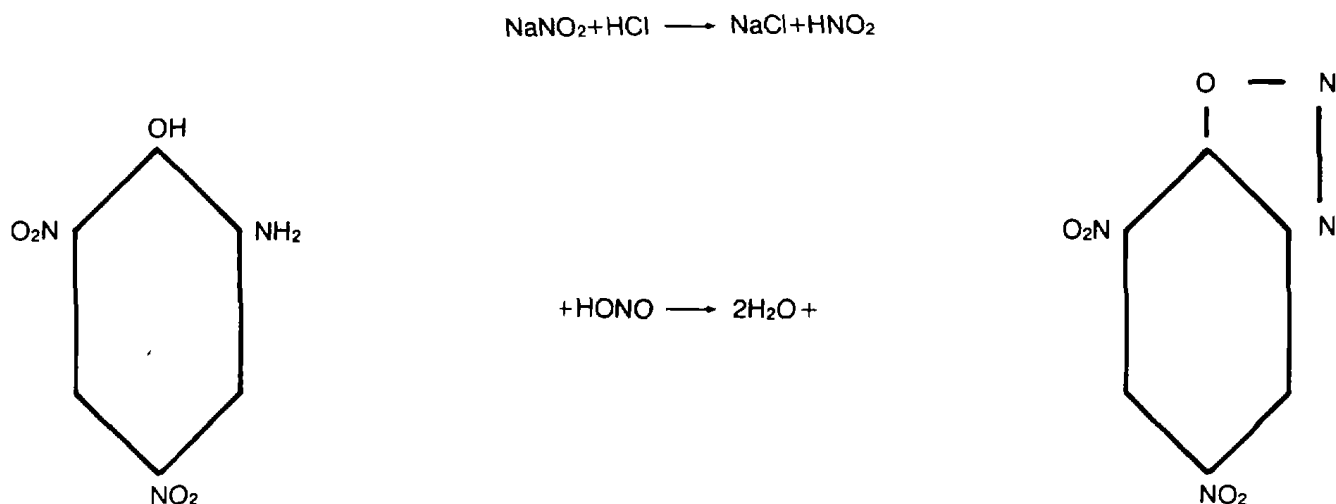

Figure 7-4. Preparation of DDNP.

g. The sand test indicates DDNP is a better initiator of detonation than mercury fulminate or lead azide for less sensitive high explosives. The most marked evidence of this is the ability of DDNP to initiate

the detonation of ammonium picrate and cast TNT. For initiation of the more sensitive high explosives, DDNP is not superior to lead azide. Comparative values showing relative initiating efficiencies are given in table 7-6.

Table 7-6. Efficiency of Initiating Compounds

	Minimum detonating charge, gram of initiator required to detonate		
	Tetryl	TNT	Ammonium picrate
Lead azide	0.10	0.26	No detonation
Mercury fulminate	0.19	0.24	No detonation
Diazodinitrophenol	0.12	0.15	0.28

h. In the vacuum stability test at 100°C, 7.6 cubic centimeters of gas are evolved from a five gram sample in 40 hours. In the 100°C heat test, 2.10 percent is lost in the first 48 hours, 2.20 percent in the second 48 hours, and no explosions occur in 100 hours. These results indicate DDNP is not as stable as lead azide, but is markedly more stable than mercury fulminate. Storage tests have shown dry DDNP to withstand storage at 50°C for at least 30 months, as compared with nine months for mercury fulminate. When stored under water, DDNP is of unimpaired brisance for 24 months at ordinary temperature and for 12 months at 50°C. The stability of DDNP, therefore, is considered satisfactory for commercial and military use, and DDNP and lead azide have replaced mercury fulminate in blasting caps to a large extent. DDNP is hygroscopic to the extent of 0.04 percent in an atmosphere of 90 percent relative humidity at 30°C.

7-5. Lead Styphnate.

a. Two forms of lead styphnate are used as primary explosives: basic (figure 7-5) and normal (figure 7-6). Basic lead styphnate has a nitrogen content of six percent and a molecular weight of 705.53. The compound has two crystal forms: yellow needles with a density of 3.878 grams per cubic centimeter and red prisms with a density of 4.059 grams per cubic centimeter. The apparent density is 1.4 to 1.6 grams per cubic centimeter. Normal lead styphnate has a nitrogen content of nine percent and the monohydrate has a molecular weight of 468.38.

The compound has yellow orange or reddish brown, rhombic, needle like crystals with a density of 3.02 grams per cubic centimeter at 30°C. The anhydrous salt has a density of 2.9 grams per cubic centimeter. Both forms of lead styphnate are soluble in aqueous ammonium acetate. Basic lead styphnate is practically insoluble in water; normal lead styphnate is only soluble to the extent of 0.04 percent at room temperature. Normal lead styphnate is even less soluble in methanol and ethanol than in water. Both forms of lead styphnate are insoluble in ether, chloroform, carbon tetrachloride, carbon disulfide, benzene, toluene, concentrated hydrochloric acid, and glacial acetic acid. Normal lead styphnate has a heat of formation of 92.3 calories per gram, a heat of combustion of 1,251 calories per gram, and a heat of detonation of 460 calories per gram. Both forms of lead styphnate are used as ingredients in priming compositions. When used alone, despite a favorable rate of detonation and good power characteristics, lead styphnate is a relatively poor initiator of detonation. Detonation of 60 percent dynamite and sometimes gelatin dynamite is possible. However, of the military high explosives, only unpressed PETN can be detonated. The minimum detonating charge for unpressed PETN is 0.55 gram, as compared to 0.30 gram of mercury fulminate or 0.40 gram of lead azide. The ease of ignition of the compound has led not only to use in priming compositions, but also use as a cover charge for igniting lead azide.

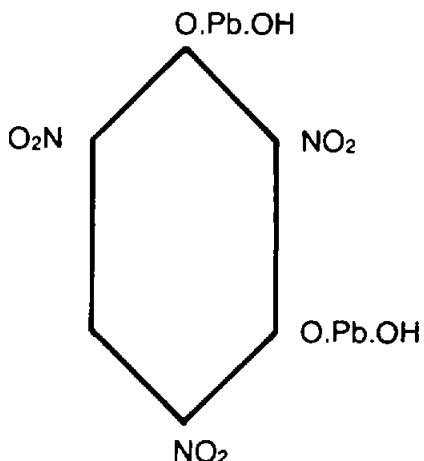

Figure 7-5. Basic lead styphnate.

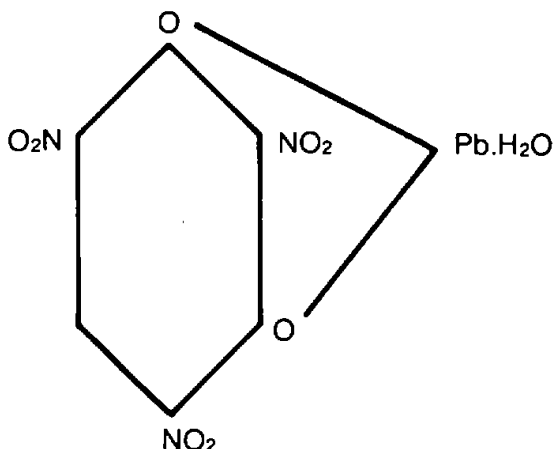

Figure 7-6. Normal lead styphnate.

b. Lead styphnate can be prepared by the reaction of lead nitrate or acetate with either sodium or magnesium styphnate in the presence of an acid. In commercial production, the magnesium salt is used. This is prepared by the reaction of magnesium oxide and styphnic acid (2,4,6-trinitroresorcinol). In one procedure, a boiling solution of lead nitrate is added to a boiling solution of sodium styphnate acidified with acetic acid. In another procedure, solutions of magnesium styphnate and lead acetate are caused to react at 70°C to form a precipitate of basic lead styphnate, which is converted into the normal salt by the addition of dilute nitric acid.

The insoluble product is filtered off and washed with water until free of acid. Like other initial detonating compounds, lead styphnate is kept under water or under a water-isopropyl alcohol mixture until used.

c. For military use basic lead styphnate must comply with the following requirements:

Appearance:	The material shall be free from visible impurities and aggregates of crystals. Type I shall be yellow to orange yellow in color. Type II shall be yellow brown to brown in color.
Crystal form:	Type I material shall consist of discrete crystals in the form of needles. Type II material shall consist of discrete crystals.
Crystal dimensions:	95 percent of the type I crystals shall have a maximum dimension between 7 and 20 microns. The length of the crystal shall not be greater than five times the width of the crystal. 95 percent of the type II crystals shall have lengths between 7 and 35 microns.
Granulation:	100 percent of the type I and II material shall pass through a US standard number 325 sieve.
Apparent density:	The apparent density of the type I material shall be 0.3 to 0.5 grams per milliliter and for the type II material, 1.40 to 1.60 grams per milliliter.
Acidity:	The pH shall be 5.0 to 6.0 in a one percent solution for the type I material, 6.0 to 7.0 for the type II material.
Material insoluble in ammonium acetate:	0.2 percent, maximum, for both type I and II material.
Material soluble in ether:	0.1 percent, maximum, for both type I and II material.
Lead content:	59.6 to 60.2 percent for both type I and II material.
Nitrogen content:	5.97 to 6.17 percent for both type I and II material.
Instantaneous flash point:	330°C to 350°C for both type I and II material.

d. For military use normal lead styphnate must comply with the following requirements:

Appearance:	The material shall be free from visible impurities and aggregates of crystals and be yellow brown to brown in color.
Crystal form:	The material shall consist of the discrete crystals of the monoclinic system and the longest dimension of any crystal shall not be greater than three times the next longest axis. Hexagonal plates are acceptable.
Crystal dimension:	The largest dimension of any crystal shall not exceed 0.5 millimeter.
Granulation:	100 percent of the material shall pass through a US standard number 100 sieve.
Apparent density:	1.30 to 1.60 grams per cubic centimeter.
Acidity:	The pH shall be between 5.0 and 6.0 in a one percent solution.
Material insoluble in ammonium acetate:	0.3 percent, maximum
Material soluble in ether:	0.1 percent, maximum
Lead content:	43.2 to 44.3 percent
Nitrogen content:	8.87 to 9.07 percent
Instantaneous flash point:	310°C to 330°C

e. Normal lead styphnate is slightly less sensitive to impact than mercury fulminate or diazodinitrophenol, but is more sensitive than lead azide. The friction sensitivity is less than that for mercury fulminate or lead

azide. The five second explosion temperature is 282°C, less than that for lead azide but much greater than those of mercury fulminate and diazodinitrophenol. Normal lead styphnate is much more easily ignited by flame or electric spark than mercury fulminate, lead azide, and diazodinitrophenol. The sensitivity to electrostatic static discharge is 0.001 joules. When ignited, the rate of detonation is less than the maximum rate. The calculated activation energy for the decomposition of lead styphnate is 61.5 kilogram-calories per gram molecule as compared with a value to 25.2 kilogram-calories for mercury fulminate.

f. When subjected to the sand test with ignition by a black powder fuse, the brisance of normal lead styphnate (10.5 grams of sand crushed) is much less than that of lead azide (16.7 grams of sand crushed). However, when initiated with a small charge of mercury fulminate or lead azide, the brisance (24 grams of sand crushed) is greater than that of lead azide or mercury fulminate. The range of brisance reported is from 27 to 53 percent of TNT. When initiated with blasting caps, lead styphnate pressed to a density of 2.9 has a rate of detonation of 5,200 meters per second, which is greater than the rate of detonation of either lead azide or mercury fulminate at the same density. Trauzl lead block tests, with large and small blocks, show lead styphnate to be more powerful than lead azide and 42 percent as powerful as TNT.

g. Normal lead styphnate is of a high order of stability as indicated by vacuum stability tests at 100°C and 120°C. In both tests 0.4 cubic centimeters of gas are evolved in 40 hours. The loss of 1.5 percent in the 100°C heat test may be attributable to the removal of the water of crystallization, which is present to the extent of 3.84 percent. Storage at 80°C caused no change in the 120°C vacuum stability test value, although the explosion temperature and sand test values were increased slightly. These changes also may be attributable to loss of the water of crystallization. The stability of lead styphnate is the same as lead azide and better than that of mercury fulminate or diazodinitrophenol. Figure 7-7 shows the DTA curve for lead styphnate and figure 7-8 shows the TGA curve.

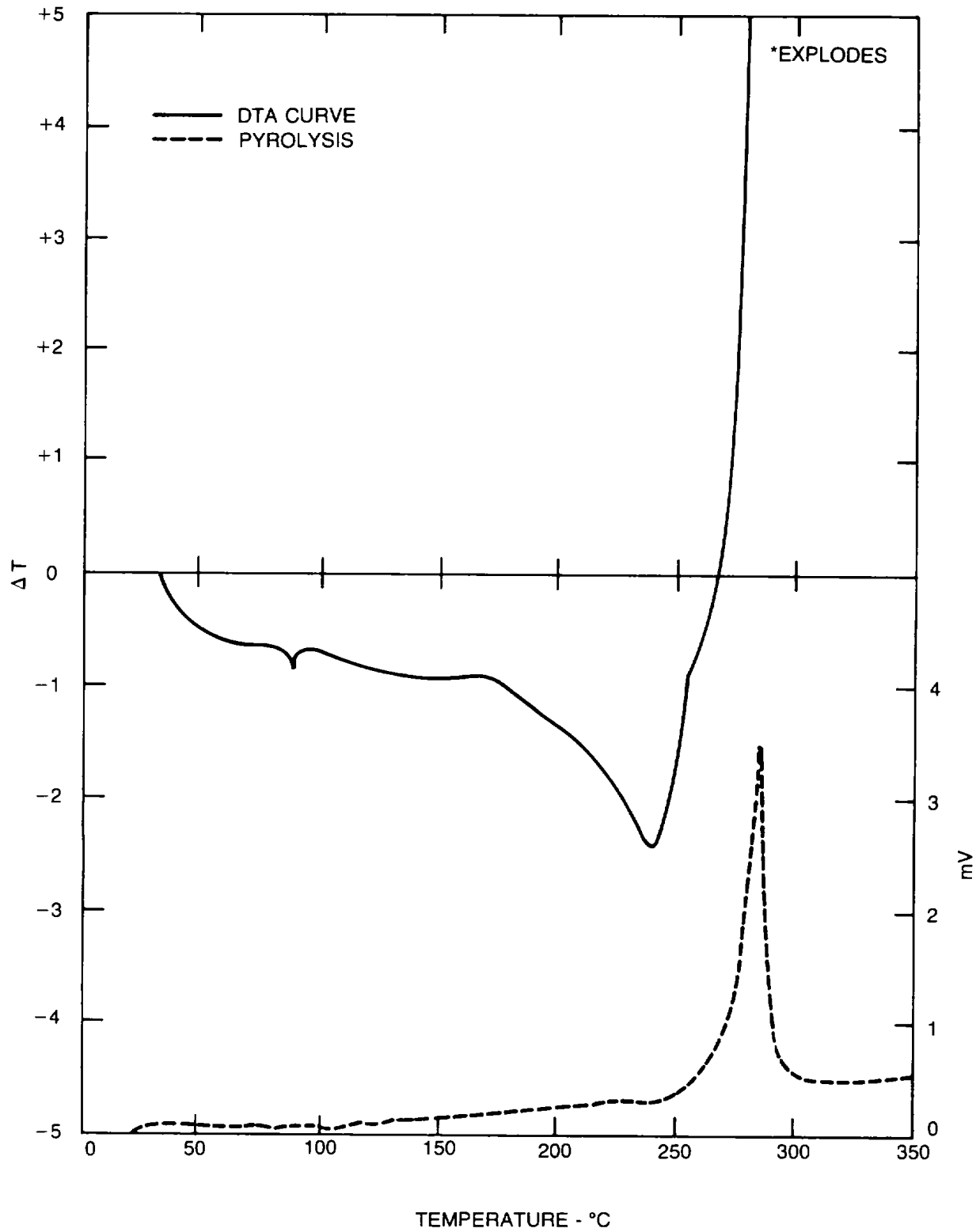

Figure 7-7. DTA curve for lead styphnate.

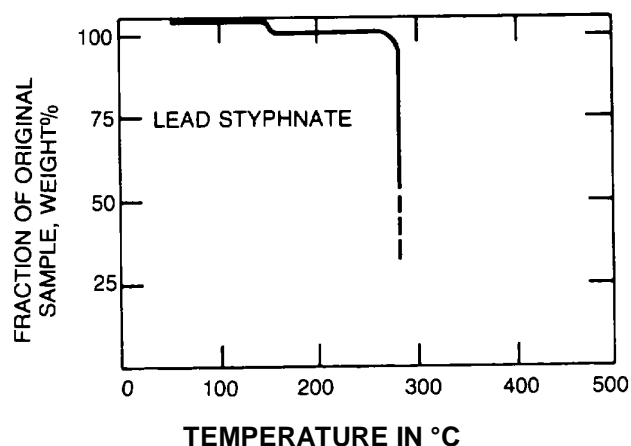

Figure 7-8. TGA curve for lead styphnate.

7-6. Tetracene.

a. Tetracene is also known as guanyldiazoguanyl tetrazene and 4-guanyl-1-(nitrosoaminoguanyl)-1 tetrazene. The compound (figure 7-9) is a colorless to pale yellow, fluffy material with needle crystals, an oxygen balance to CO_2 of 57.6 percent, an oxygen balance to CO of 43 percent, a nitrogen content of 74.4 percent, and a molecular weight of 188.15. Tetracene forms a hydrate with three molecules of water. The melting point of the pure compound is between 140°C and 160°C accompanied by decomposition and explosion. The apparent density is only 0.45 grams per cubic centimeter. When compressed at 20,685 kilopascals (3,000 pounds per square inch), the density is 1.05 grams per cubic centimeter. The crystal density is 1.7 grams per cubic centimeter. The compound can be easily dead pressed. Tetracene is practically insoluble in water and ethanol and so can be stored wet with water or a mixture of water and ethanol. The compound is also insoluble in ether, benzene, acetone, carbon tetrachloride, and ethylene dichloride. Tetracene is soluble in dilute nitric acid or strong hydrochloric acid. In a solution with hydrochloric acid, the hydrochloride is precipitated by the addition of ether. Tetracene may then be recovered by treatment with sodium acetate or ammonium hydroxide. The heat of formation is 270 calories per gram and the heat of detonation is 658

calories per gram. Tetracene can be used in detonators when initiated by another primary explosive. In such cases, the tetracene functions as an intermediate booster or as a sensitizer to flame or heat. In some cases, tetracene is used in primers where as little as two percent tetracene in the composition results in uniformity of percussion sensitivity.

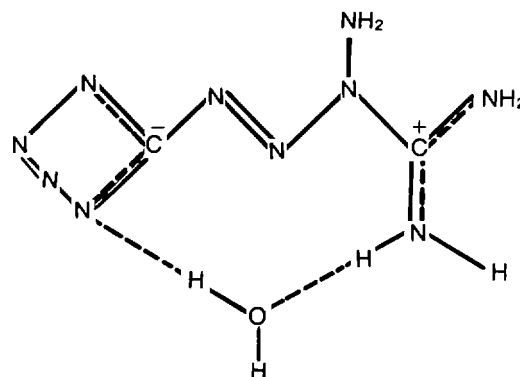

Figure 7-9. Structural formula for tetracene.

b. Boiling water decomposes tetracene liberating two molecules of nitrogen per molecule of tetracene. Hydrolysis with sodium hydroxide yields ammonia, cyanamide, and triazonitrosoaminoguanidine ($\text{N}_3\text{C}(\text{NH})\text{NH}\text{NH}\text{NO}$). Tetracene reacts with an excess of silver nitrate to form the double salt $\text{C}_2\text{H}_7\text{N}_{10}\text{OAg}\cdot\text{AgNO}_3\cdot 3\text{H}_2\text{O}$ and forms explosive salts such as the perchlorate.

c. To prepare tetracene, 34 grams of aminoguanidine carbonate are dissolved, with warming, in a mixture of 2.5 liters of water and 15.7 grams of glacial acetic acid. After the solution has been filtered and cooled to 30°C , 27.6 grams of solid sodium nitrite are added. The sodium nitrite is dissolved by stirring. After standing for three or four hours, the solution is shaken to start precipitation and the mixture is allowed to stand for about 20 hours longer. The precipitate of tetracene is separated and washed with water until free from acid. An alternate method is to dissolve five grams of aminoguanidine dinitrate in 30 milliliters of distilled water, cooling to 0°C , and mixing with a solution

of 2.5 grams of sodium nitrite in 15 milliliters of water. While maintaining the temperature at 10°C, 0.5 grams of glacial acetic acid is added to precipitate the tetracene. After allowing the slurry to stand, at least overnight, the precipitate is washed by decantation with several portions of water and then transferred to a filter to be washed more thoroughly with water using suction. Then the product is air dried at room temperature. Another method for the preparation of tetracene uses aminoguanidine sulfate and sodium nitrite in distilled water.

d. Tetracene must meet the following requirements for military use:

Color and appearance:	Tetracene shall be white to light yellow and under the microscope shall appear as needle shaped crystals.
Melting and explosion point:	130±2°C.
Granulation:	100 percent shall pass through a US number 45 standard sieve.
Specific gravity:	1.65±0.05.
Heavy metals:	There shall be no heavy metals present.
Nitrogen content:	74.5+1 percent.

e. Tetracene is of the same order of sensitivity as mercury fulminate and diazodinitrophenol. Using the Bureau of Mines apparatus with a two kilogram weight, the result obtained is seven centimeters as compared to five centimeters for mercury fulminate. Using the Picatinny Arsenal apparatus with a 226.8 gram (eight ounce) weight, the result obtained is eight inches, as compared to nine to ten inches for mercury fulminate. The five second explosion temperature (160°C) is relatively low as compared with the other initial detonating agents. This ease of ignition along with a relatively high heat of explosion and large gas volume produced makes tetracene useful in priming compositions and with lead azide in explosive rivets. When exposed to contact with a flame, tetracene undergoes mild explosion with the production of much black smoke. The minimum detonating charge of mercury fulminate is 0.40 grams.

f. In the sand test, loose tetracene crushes 13.1 grams of sand, but when loaded under a pressure of 20,685 kilopascals (3,000 pounds per square inch), only two grams of sand are crushed. However, tetracene pressed at 20,685 kilopascals crushes 21.1 grams of sand when initiated with mercury fulminate. This maximum brisance is equal to that of mercury fulminate.

The range of brisance values reported are 40 percent to 70 percent of TNT. The volume of gas developed on explosion is 1,190 cubic centimeters per gram. The Trauzl test indicates tetracene has a power of 51 to 63 percent of TNT.

g. Unpressed tetracene, when ignited by a flame, can cause the detonation of loose or pressed PETN, but pressed tetracene does not detonate PETN. Unpressed tetracene can cause low order detonation of tetryl. The unpressed material, however, cannot detonate TNT even when primed with mercury fulminate. Tetracene, therefore, does not have sufficient initiating efficiency to be used with military high explosives.

h. Tetracene is relatively stable at temperatures not greater than 75°C. However, in the 100°C heat test, extreme decomposition occurs in the first 48 hours. The reactivity with water and the slightly high 75°C international test value (0.5 percent) indicate an order of stability approximating that of mercury fulminate. Tetracene gains only 0.77 percent in an atmosphere with 90 percent relative humidity at 30°C.

7-7. Potassium Dinitrobenzofuroxane (KDNBF).

a. KDNBF (figure 7-10) is a red crystalline solid with a nitrogen content of 21.21 percent and molecular weight of 264.20. The oxygen balance of the compound to CO₂, H₂O, and K₂O is -42.4 percent. The anhydrous salt has a density of 2.21 grams per cubic centimeter and a melting point, with explosive decomposition, of 210°C. KDNBF is soluble to the extent of 0.245 grams per 100 grams of water at 30°C. Between the temperatures of 50C to 50°C the specific heat is 0.217 calories per gram per degree centigrade. KDNBF is used in primary compositions.

b. Using a .45 kilogram (one pound) weight in the Picatinny Arsenal impact apparatus, the drop height is only six inches. In the pendulum friction test, KDNBF explodes with both the steel and fiber shoes. The minimum charge required for initiation is 0.30 grams of mercury fulminate or 0.10 grams of lead azide. The sensitivity of KDNBF is between that of mercury fulminate and lead azide.

c. In the sand test, 44.8 grams of sand are crushed, which indicates a brisance of 93 percent of TNT. The volume of gas developed on explosion is 604 cubic centimeters per gram.

d. In the 100°C heat test, the weight loss in the first 48 hours is 0.03 percent and in the second 48 hours 0.05 percent with no explosions in 100 hours. At 30°C and 90 percent relative humidity KDNBF is hygroscopic to the extent of 0.27 percent.

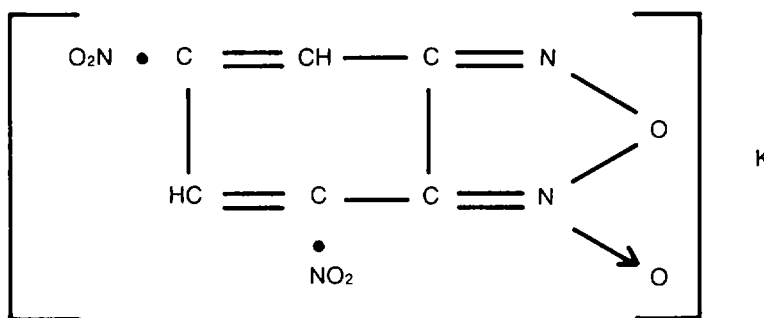

Figure 7-10. Structural formula for KDNBF.

e. The specifications for KDNBF are:

Color: Light orange to dark red.
 Bulk density: 0.2 grams per milliliter, minimum.
 Forms: KDNBF shall be in the form of plate-like crystals. In addition, the dried KDNBF powder shall be easily dispersible.

Granulation: Through a No. 50 US standard sieve, 98 percent minimum.
 Retained on a No. 100 US standard sieve, 4 percent maximum.
 Retained on a No. 200 US standard sieve, 10 to 75 percent.
 Retained on a No. 270 US standard sieve, 85.0 to 100 percent.

Vacuum stability: Not more than 1.0 milliliters of gas shall be evolved at 120° ± 0.5°C in 40 hours.

Nitrogen content: 19.75 percent-0.20 percent.

Differential thermal analysis: The DTA graph of the tested KDNBF sample shall show only one major exotherm and that exotherm shall occur between 210°C and 225°C.

Nuclear magnetic resonance: The NMR spectra of the tested KDNBF sample shall have five distinct peaks one each at 5.77, 5.93, 6.13, 6.27, and 8.63 ppm. The average amplitude of the peaks at 5.93 and 6.13 ppm shall be greater than

thirty percent of the peak at 8.63 ppm. In addition, there shall be no peak at 9.22 ppm greater than five percent of the peak at 8.63 ppm.

7-8. Lead Mononitroresorcinate (LMNR).

a. LMNR (figure 7-11) has a nitrogen content of 3.89 percent, an NO₂ content of 12.77 percent, a lead content of 57.51 percent, and a molecular weight of 360.30. The compound forms microscopic reddish brown crystals. LMNR has slow burning properties and a low combustion temperature. The compound is used in electric detonators with DLA as the spot charge to initiate a PETN base charge, as an upper charge, and as an ingredient in primary compositions.

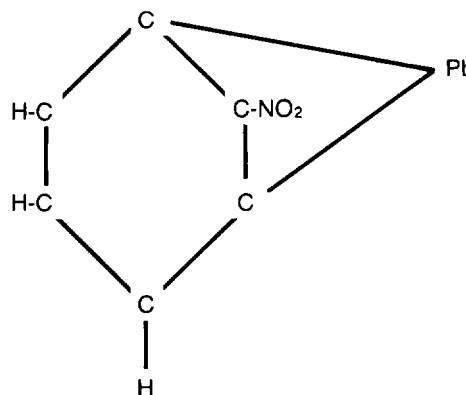

Figure 7-11. Structural formula for LMNR.

b. LMNR is prepared by mononitrating recorcinol then allowing the slurry of mononitrorecorcinol to react with Pb(OH)₂ at elevated temperatures. The LMNR is stored and transported under water with not less than 10 percent denatured alcohol.

c. LMNR must meet the following requirements for military use:

Color and appearance:	LMNR shall be light brown in color.
Apparent density:	0.20 to 0.35 grams per milliliter.
Acidity:	The pH shall be between 5.0 and 6.5 for a solution of one gram of the material in 150 milliliters of water.
Lead content:	70.5 to 72.5 percent.
Nitro group content:	7.2 to 7.6 percent.
Vacuum stability at 120°C:	0.4 milliliters of gas in 40 hours with a 2.3 gram sample, maximum.

sulfide, and calcium silicide. The last two also serve to sensitize the composition to friction or percussion. Oxidizing agents include potassium chlorate and barium nitrate. Other ingredients include primary explosives and binders. The major determining factor in ingredient selection is the impetus which is to detonate the priming composition. The types of impetus commonly used are percussion and electrical.

b. Percussion type primers are used extensively for the ignition of propellants. In the early 1900's this type of priming composition contained mercury fulminates. At the present time, however, mercury fulminate has been replaced by more stable compounds. Potassium chlorate was used in this type of priming composition from about 1917 through World War II. Except for special applications, the use of this compound has been discontinued because of the corrosive action of potassium chloride, a decomposition product of potassium chlorate, on gun barrels. Potassium chlorate is still used in high temperature priming compositions. Table 7-7 lists the composition of two such mixtures. The percentages listed are by weight. Table 7-8 lists several commonly used percussion priming compositions.

7-9. Primary Compositions.

a. Primary compositions are mixtures of primary explosives, fuels, oxidizers, and other ingredients used to initiate detonation in high explosive charges or ignite propellants and pyrotechnics. The ingredients and the portions of the ingredients for individual priming compositions are determined empirically from the use the composition is intended for. Fuels commonly used in priming compositions are lead thiocyanate, antimony

Table 7-7. High Temperature Percussion Primers

	G-11	G-16
Potassium chlorate, %	53	53
Antimony trisulfide, %	25	30
Calcium silicide, %	12	17
Temperature resistant explosive, %	10	-

Table 7-8. Percussion Priming Compositions

	FA959	Composition FA982	FA956
Normal lead styphnate, %	35	36	37
Tetracene, %	3.1	12	4
Barium nitrate, %	31	22	32
Antimony sulfide, %	10.3	7	15
Powdered zirconium, %	10.3	9	
Lead dioxide, %	10.3	9	
PETN	-	5	5
Aluminum,	-	-	7
Gum arabic	-	-	0.2 (added)
Autoignition temperature	199°C	240°C	184°C
Decomposition temperature	209°C	262°C	193°C

Table 7-8. Percussion Priming Compositions (Continued)

	FA959	Composition FA982	FA956
Density in grams per cubic centimeter	1.3-2.3(bulk)	1.4-2.4	1.3-2.4
Fuel to oxidizer ratio	0.5 to 1	0.52 to 1	0.69 to 1
Gas volume produced	5-10 milliliters per gram	5-10 milliliters per gram	5-10 milliliters per gram
Electrical spark sensitivity	< 0.05 joules		
Friction sensitivity	yes		

The output of percussion type primers includes hot gases, hot particles, thermal radiation, and a pressure pulse. In some cases the pressure pulse may be a shock wave.

c. Stab detonators are used to directly initiate secondary explosives. As the name implies, a stab detonator is initiated by penetration of a firing pin. The mechanical energy of the firing pin is converted to heat, which causes detonation. Rather than using one homogenous priming mixture as percussion type primers do, stab detonators contain three layers of charges; primary, intermediate, and base. Priming compositions used in the primary charge are shown in

table 7-9. The intermediate charge is an energetic material such as lead azide or black powder. The base charge may be lead azide, black powder, or a more brisant explosive such as RDX or PETN. The base charge initiates the secondary explosive.

d. Electrical primers are of several types:

- (1) exploding bridge wire
- (2) hot wire bridge
- (3) film bridge
- (4) conductive mixture
- (5) spark gap

Table 7-9. Stab Detonator Priming Compositions

	NOL 130	Composition PA101	NOL 60
Lead azide, %	20		
Basic lead styphnate, %	40	53	60
Tetracene, %	5	5	5
Barium nitrate, %	20	22	25
Antimony sulfide, %	15	10	10
Powdered aluminum, %	-	10	-
Autoignition temperature	274°C	196°C	210°C
Decomposition temperature	280°C	215°C	227°C
Density in grams per cubic centimeter	1.85 (loading)	1.3-2.0	1.3-2.0
Fuel to oxidizer ratio	0.75 to 1	0.91 to 1	0.4 to 1
Gas volume produced	10-25 milliliters per gram	5-10 milliliters per gram	5-10 milliliters per gram
Electrical spark sensitivity	0.0022 joules	<0.05 joules	0.0022 joules
Friction sensitivity	yes	yes	yes
Hygroscopic	yes	yes	yes

In an exploding bridge wire detonator, a large current is passed through a wire which causes the wire to burst. The bursting of the wire causes a shock wave that is of sufficient strength to cause detonation. With this type of primer no priming composition is used; the wire is placed directly in a charge of RDX or PETN. Hot wire bridges and film bridges use priming compositions.

Examples are listed in table 7-10. In these detonators the wire or film is heated by an electric current. The heat causes ignition of the charge which may then undergo a deflagration to detonation transfer. The functioning of a conductive mixture or spark gap primer is readily apparent from the name. These two types of primers are not commonly used.

Table 7-10. Electric Priming Compositions

	Composition					
	I	II	III	IV	V	VI
Potassium chlorate, %	8.5	55	25	60	66.7	66.7
Lead mononitroresorcinate, %	76.5	-	-	-	-	-
Nitrocellulose, %	15.0	-	-	-	-	-
Lead thiocyanate, %	-	45	-	-	-	-
DDNP, %	-	-	75	20	-	-
Charcoal, %	-	-	-	15	-	-
Nitrostarch, %	-	-	-	5	-	-
Titanium, %	-	-	-	-	-	33.3
Aluminum, %	-	-	-	-	-	33.3
Autoignition temperature	244°C	203°C	396°C	396°C	475°C	446°C
Decomposition temperature	296°C	240°C	451° C	442°C	486°C	465°C
Density in grams per cubic centimeter	1.9-2.6	1.6-2.2	1.6-2.2	1.6-2.4	2.16-2.36	0.6
Fuel to oxidizer ratio	0.9 to 1	0.82 to 1	0.3 to 1	0.25 to 1	0.5 to 1	0.5 to 1
Gas volume produced	-	-	148 milliliters per gram	96 milliliters per gram	286 milliliters per gram	150 milliliters per gram

CHAPTER 8 UNITED STATES BOOSTER AND SECONDARY EXPLOSIVES

8-1. Introduction. This chapter contains discussions of military high explosive compounds. The explosives are arranged by chemical class. The chemical, physical, and thermochemical characteristics, sensitivity, performance, and stability are discussed for each explosive. The chemical structure of each compound is given, and for composition explosives, the ingredients are given. The method of manufacture is also given.

8-2. Aliphatic Nitrate Esters. Compounds in this class are prepared by O-type nitration in which a nitro group is attached to an oxygen atom of the compound being nitrated.

a. *1,2,4-Butanetriol Trinitrate (BTN).* This explosive is also known as α , β , γ -trihydroxybutane trinitrate and is sometimes referred to as BTTN. The compound (figure 8-1) is a light yellow liquid with a density of 1.520 at 20°C, a molecular weight of 241, a melting point of -27°C, an oxygen balance to CO₂ of 17 percent, and a refractive index of 1.4738 at 20°C. The liquid has a viscosity of 62 centipoises at 20°C. 1,2,4-Butanetriol trinitrate is slightly soluble in water, miscible with alcohol, ether, acetone, and a solution of 2 parts ether and 1 part alcohol. BTN has a heat of formation of 368 calories per gram, a heat of combustion of 2,167 calories per gram, and a heat of detonation of 1,458 calories per gram. This compound is a good gelatinizer for nitrocellulose and can be used as a substitute for nitroglycerin in double-base propellants. Heat, vacuum stability, and volatility tests indicate more stability than nitroglycerin. Impact sensitivity is about the same as for nitroglycerin. Brisance, as measured by the sand test, is about the same: 49 grams crushed versus 51.5 grams for nitroglycerin or 47 grams for TNT. The five second explosion temperature is 230°C versus 220°C for nitroglycerin. BTN can be manufactured by the nitration of 1,2,4-butanetriol with a mixture of nitric and sulfuric acids.

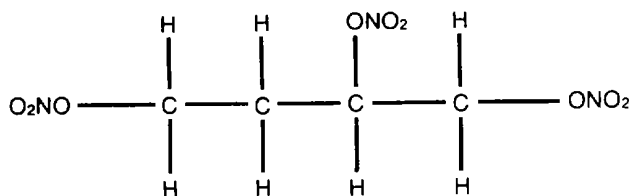

Figure 8-1. Structural formula for BTN.

b. *Diethyleneglycol Dinitrate (DEGN).*

(1) This explosive is also known as dinitrodiglycol or 2,2'-oxybisethanol dinitrate and is sometimes referred to as DEGDN. The compound (figure 8-2) is a clear, colorless, odorless liquid with a nitrogen content of 14.29 percent, a theoretical maximum density of 1.39 grams per cubic centimeter, an oxygen balance to CO₂ of -41 percent, and a molecular weight of 196. DEGN boils between 160° and 161°C and can, upon cooling, form a stable solid with a melting point of 2°C or remain liquid to a freezing point of -11.2° to 11.40°C. Other characteristics of the liquid are: refractive index at 20°C with sodium light, 1.450; viscosity at 20°C, 8.1 centipoises; vapor pressure at 20°C, 0.0036 torr; vapor pressure at 25°C, 0.00593 torr; vapor pressure at 60°C, 0.130 torr; specific gravity, 1.385. At 60°C DEGN has a volatility of 0.19 milligrams per square centimeter per hour. At constant pressure, the heat of combustion is 2,792 calories per gram. The heat of formation is -99.4 kilogram calories per mole. The heat of detonation is 1,161 calories per gram. DEGN is readily soluble in ether, acetone, chloroform, benzene, nitrobenzene, toluene, nitroglycerin, and glacial acetic acid but is insoluble in ethanol, carbon tetrachloride, and carbon disulfide. Solubility in water at 25°C and 60°C is 0.40 and 0.46 gram per 100 grams, respectively. DEGN's chemical reactivity is similar to nitroglycerin's, but is less subject to hydrolysis and is not readily saponified by alcoholic sodium hydroxide. DEGN can be used as an explosive and can be used in propellants as a colloidizing agent for nitrocellulose. Propellants based on DEGN and nitrocellulose develop relatively low temperatures and cause relatively little erosion of guns, but are unduly volatile.

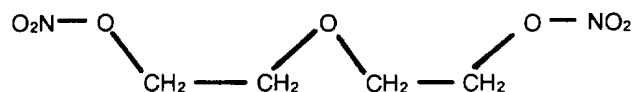

Figure 8-2. Structural formula for DEGN.

(2) DEGN can be manufactured with a yield of approximately 85 percent of the theoretical by adding diethylene glycol to mixed acid containing approximately 50.3 percent nitric acid, 44.7 percent sulfuric acid, and 5.0 percent water. The temperature of the mixture is kept at 10° to 15°C. The spent acid is very unstable and fumes off if heated or allowed to stand for a few hours. The separated DEGN is purified by washing with successive portions of water, dilute sodium carbonate solution, and water until neutral. The purity of the product is dependent mainly on the purity of the diethylene glycol used in the manufacturing process.

(3) DEGN is so insensitive that mixing with another nitrated compound is required to produce a useful explosive. DEGN alone, however, does explode in the pendulum friction test. The explosion temperature test value for DEGN is 237°C.

(4) As indicated by the vacuum stability tests, DEGN is much more stable than nitroglycerin at 100°C and will, when free from acidity, withstand long term storage at ordinary temperatures.

(5) The brisance of DEGN, as judged by the modified sand test, is equal to that of TNT and 81 percent that of nitroglycerin. At a density of 1.38 grams per cubic centimeter, DEGN's rate of detonation is 6,760 meters per second, slightly less than TNT's. The Trauzl lead block test indicates DEGN to be 144 to 150 percent as powerful as TNT and 77 percent as powerful as nitroglycerin. The ballistic pendulum test indicates DEGN to be 127 percent as powerful as TNT and 90 percent as powerful as nitroglycerin.

c. Nitrocellulose (NC).

(1) Nitrocellulose or cellulose nitrate is a mixture of nitrates obtained by nitrating cellulose. Cellulose (figure 8-3) is a long chain polymer of anhydroglucose units ($C_5H_{10}O_5$). The number of anhydroglucose units or degree of polymerization (DP) is variable. Cellulose used for preparation of military grades of nitrocellulose have a DP of approximately 1,000 to 1,500. Cellulose threads possess micellar structure and consist of numerous rod-like crystallites oriented with their long axis parallel to the thread axis, thus forming a fiber. Almost pure cellulose is found in the pith of certain plants, in absorbent cotton, and in some filter papers. Pure cellulose is most readily obtained from cotton by treating with a dilute acid or base solution then thoroughly washing with water. At the present time most

of the cellulose for nitrocellulose preparation is obtained from coniferous wood, which is 50 to 60 percent cellulose. Another source is straw, which is 30 to 40 percent cellulose. The nitration of cellulose involves replacement of the hydrogen in the three hydroxyl (OH) groups in the anhydroglucose units with NO_2 groups. A representative formula for the nitrated cellulose may be written as $C_6H_7(OH)_x(ONO_2)_y$ where $x+y=3$. The mononitrate, $x=2$ and $y=1$, has a nitrogen content of 6.76 percent; the dinitrate, $x=1$ and $y=2$, has a nitrogen content of 11.11 percent; the trinitrate, $x=0$ and $y=3$, has a nitrogen content of 14.14 percent. As a practical matter, however, any desired degree of nitration up to 14.14 percent may be obtained by adjusting the composition of the mixed acid used for nitration, the acid to cellulose ratio, the time of nitration, or the temperature of nitration. In nitrocellulose with less than 14.14 percent nitrogen, the NO_2 groups are distributed randomly along the entire length of the cellulose polymer, so x and y should be regarded as average values over the entire length of the chain. The nitrogen content determines the chemical and physical properties of any particular nitrocellulose. The five grades of nitrocellulose listed below are recognized and used.

(a) Pyroxylin or collodion, which contains from about 8 to 12.3 percent nitrogen, is light yellow, matted filaments. The theoretical maximum density is 1.653 grams per cubic centimeter, the melting point with decomposition is greater than 135°C, and the heat of formation is -216 kilocalories per mole for pyroxylin with a nitrogen content of 12 percent. When dissolved in 3 parts ether and 1 part alcohol, the solution is pale yellow and viscous. Pyroxylin is also soluble in acetone or glacial acetic acid, and is precipitated from solution by water. When thin layers of solutions are permitted to evaporate, the pyroxylin forms a tough, colorless film. Pyroxylin is very flammable and is decomposed by light. The pyroxylin used for the manufacture of celluloid contains 11.0 to 11.2 percent nitrogen, while that used in the manufacture of blasting explosives has a nitrogen content of 11.5 to 12.0 percent. The pyroxylin used for military purposes contains 12.20 ±0.10 percent of nitrogen. Pyroxylin with 11.13 percent nitrogen is hydrolyzed to the extent of 1.71 percent of the available nitrogen after 240 hours of boiling in water. The heat of detonation of pyroxylin with a nitrogen content of 12 percent is 1.16 kilocalories per gram for liquid water and 1.02 kilocalories per gram for gaseous water.

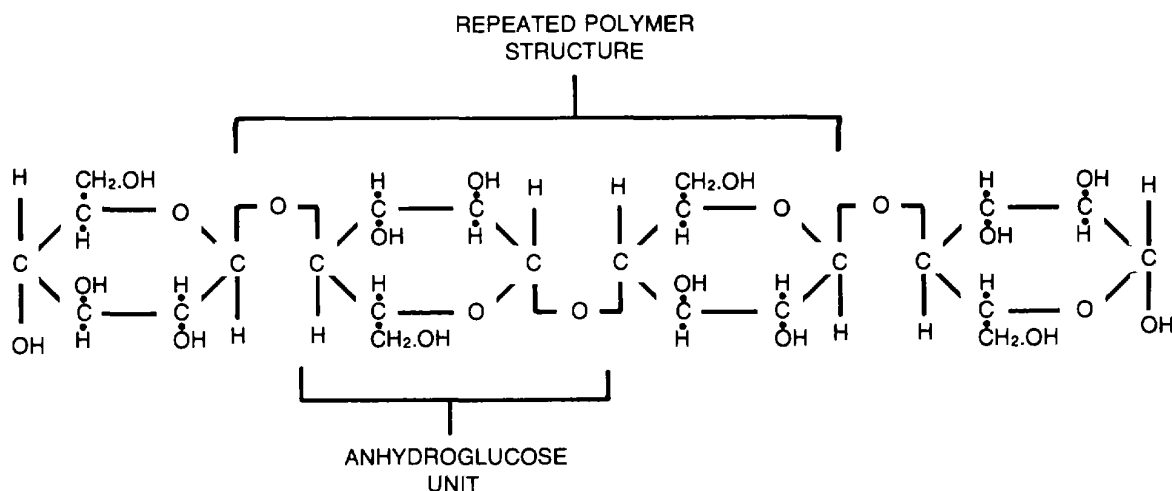

Figure 8-3. Cellulose.

(b) Pyrocellulose is a type of nitrocellulose which has a nitrogen content of 12.60 ± 0.10 percent. Pyrocellulose is insoluble in water and ether but 99 percent dissolves in a solution of 2 parts ether and 1 part alcohol, 21 percent dissolves in ethyl nitroacetate, and 11 percent dissolves in alcohol. Pyrocellulose is soluble in acetone, ethyl acetate, methyl acetate, propylene oxide, nitromethane, and nitroethane but solubility is not limited to these. Pyrocellulose is used as a propellant and in propellant mixtures. Pyrocellulose with 12.6 percent nitrogen is hydrolyzed to the extent of 1.22 percent of the available nitrogen after 240 hours of boiling in water. The specific heat of pyrocellulose with a nitrogen content of 12.6 percent is 0.3478 calories per gram per degree centigrade at 25°C .

(c) Guncotton is the grade of nitrocellulose that contains the highest percentage of nitrogen obtainable by nitrating cellulose with mixed nitric and sulfuric acids. The percentage of nitrogen is 13.35 to 13.45 percent. The theoretical maximum density is 1.656 grams per cubic centimeter, the melting point with decomposition is greater than 135°C , and the heat of formation is -200 kilocalories per mole for guncotton with a nitrogen content of 13.35 percent. Guncotton is insoluble in water and ether, very slightly soluble in alcohol, about 4 to 10 percent soluble in a solution of 2 parts ether and 1 part alcohol, and soluble in acetone, ethyl acetate, and other organic solvents. Guncotton is used as a propellant and as a primer in electric detonators. Guncotton with 13.44 percent nitrogen is hydrolyzed to the extent of 1.03 percent of the available nitrogen after 240 hours of boiling in water.

The heat of detonation of guncotton with a nitrogen content of 13.35 percent is 1.16 kilocalories per gram for liquid water and 1.02 kilocalories per gram for gaseous water. The specific heat of guncotton with a nitrogen content of 13.4 percent is 0.3408 calories per gram per degree centigrade at 25°C .

(d) High nitrogen nitrocellulose is the grade of nitrocellulose that contains from 13.75 to 14.14 percent nitrogen. The theoretical maximum density is 1.659 grams per cubic centimeter and the heat of formation is -191 kilocalories per mole for nitrocellulose with a nitrogen content of 14.14 percent. The compound is insoluble in water, ether, n-propyl alcohol, and isopropyl alcohol, but about 0.6 percent soluble in ethanol, 1 percent soluble in methyl alcohol, 1.4 percent soluble in a solution of 2 parts ether and 1 part alcohol, 20 percent soluble in methyl acetate, 42 percent soluble in nitromethane, 86 percent soluble in 1-nitropropane, and 100 percent soluble in acetone, ether acetate, propylene oxide, and amyl acetate. High nitrogen nitrocellulose can be used in the preparation of propellants with higher ballistic potential than guncotton, but it is not used in U.S. standard propellants because it is too costly to manufacture. The heat of detonation for nitrocellulose with a nitrogen content of 14.14 percent is 1.95 kilocalories per mole for liquid water and 1.81 kilocalories per mole for gaseous water. The specific heat for nitrocellulose with a nitrogen content of 14.14 percent is 0.3362 calories per gram per degree centigrade.

(e) Blended nitrocellulose is a mixture of 60 to 65 percent guncotton and 35 to 40 percent pyrocellulose. The guncotton should have a nitrogen content of 13.4 percent and the pyrocellulose nitrogen content should be 12.6 percent. Straight guncotton has a higher ballistic potential than blended nitrocellulose but is only slightly soluble in an ether-alcohol solution, the mixture most commonly used in the United States to colloid nitrocellulose. Blended nitrocellulose of the proportions given above is soluble to the extent of about 37 ± 2 percent in a mixture of 2 parts ether and 1 part alcohol. This property makes blended nitrocellulose suitable as a single-base propellant. Two grades of nitrocellulose are commonly used: one with a nitrogen content of 13.15 ± 0.05 percent and one with a nitrogen content of 13.25 ± 0.05 percent.

(2) X-ray diffraction studies have yielded the following information regarding the nitration of cellulose. In the first stage of nitration, nitric acid penetrates the entire cellulose structure. The amorphous part of the cellulose is more reactive than the crystalline part, so the second stage involves nitration of the amorphous part. At the same time the micellar arrangement is being broken down. The third stage of nitration involves the swelling and breakdown of the micellar arrangement. Swelling takes place as shown in figure 8-4. The nitrating agent, as is the case with any esterifying reagent, attacks one end of the micelle and causes a gradual sliding apart of the chain as nitration proceeds. When 12.2 percent nitrogen content is reached, an orderly arrangement of the chains becomes possible and there is a sudden appearance of the trinitrate crystalline structure. The nitration of cellulose is a reversible reaction, proceeding as:

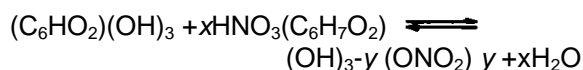

where y varies between 0 and 3 over the length of the polymer. Therefore, an equilibrium exists for each concentration of nitrating acid, which corresponds to a definite degree of nitration, provided all other conditions, such as temperature and pressure, remain the same. This means that if the concentration of nitrating bath containing nitrocellulose nitrated to a certain nitrogen content, is slightly weakened by the addition of water, the reaction will go from right to left and nitrocellulose will be partly hydrolyzed to the nitrogen content corresponding to the concentration of the new nitrating bath. This reaction is known as denitration. The rate of denitration is insignificant if the acid is rapidly diluted to a very low concentration and cooled at the same time as, for example, when nitrocellulose wet with acid is

drowned in a large amount of ice water. If, on the other hand, drowning is done into a small amount of water and the temperature is allowed to rise, a certain amount of denitration takes place. During the wringing operation, which removes the spent mixed acid, if the nitrocellulose is left in contact with a humid atmosphere longer than usual, considerable denitration takes place, especially in the outer layers of the wrung nitrocellulose.

(3) A point should be made here regarding the mechanism of solubility of nitrocellulose. As a general rule, solvents for polymers like nitrocellulose act at first as swelling agents and only afterwards as dispersing reactants. The fibrous structure of nitrocellulose is not lost when swelling compounds such as cyclohexanone, fenchone, and meta-xylene are used. When nitrocellulose is treated with a solvent a gel is obtained and the phenomena known as gelatinization occurs. A volatile solvent can be evaporated in order to obtain a plasticlike colloided material. A smokeless nitrocellulose propellant processed with the aid of an ether-alcohol mixture is an example. If the solvent is nonvolatile or only slightly volatile, the nitrocellulose forms a gel, but usually heat is required for completion of the operation. A double-base, solventless, smokeless propellant is an example. If heating is undesirable because of danger, gelatinization can be achieved by blending nitrocellulose at room temperature with a gelatinizer dissolved or suspended in a liquid, such as alcohol, which is not necessarily a solvent for nitrocellulose. If a solid solvent such as camphor is used in the preparation of celluloid, the water-wet nitrocellulose is mixed with powdered camphor, some alcohol is added, and the mass is kneaded at room temperature for several hours. The process is usually called plasticization. Both gelatinization and plasticization yield similar materials which are flexible and crack resistant. The difference is a gelatinizer tends to draw the molecules together and a plasticizer spreads them out. The solubility of nitrocellulose in organic solvents and the formation of gels is attributed to formation of molecular addition compounds between nitrocellulose and the solvent.

(4) In the manufacture of nitrocellulose, the first step is the pretreatment of the cellulose. Short fibered cotton or cotton linters that have been suitably purified by washing with water are dried at 105° to 110°C until the moisture content is reduced from 6 to 7 percent to about 0.5 percent. If the starting material is wood pulp, the pulp sheets are fed into a drier maintained at 110° to 115°C . During a drying time of about 15 minutes, the moisture content is reduced from 4 to 5 percent to about 0.5

percent. The dried pulp sheets pass from the drier into a shredder where they are reduced to pieces about five millimeters in length. In storage, the cellulose should be kept in airtight containers to prevent moisture from being absorbed. The cellulose is nitrated by the mechanical dipper process which has displaced other, more hazardous processes. The composition of the mixed acid used in this process varies depending on the

type of cellulose nitrated, the degree of nitration desired, and the season of the year. Higher temperatures cause denitration of the mixed acid, so the nitric acid content must be greater during the summer than during the winter. Table 8-1 lists typical compositions of mixed acid.

Table 8-1. Compositions of Mixed Acids for Nitrating Cellulose

	For pyrocellulose from -		For guncotton from -		For high nitrogen nitrocellulose	
	Cotton linters Percent	Wood pulp cellulose Percent	Cotton linters Percent	Wood pulp cellulose Percent	13.8%N Percent	13.8%N Percent
Sulfuric acid	59.2	57.0	60.5	59.5	-	-
Nitric acid	21.5	23.5	24.5	28.5	49	70-85
Nitrosylsulfuric acid	3.5	4.4	4.0	3.0	-	-
Water	15.8	15.1	11.0	9.0	-	-
Phosphoric acid	-	-	-	-	49	-
Phosphoric anhydride	-	-	-	-	2	-
Ammonium nitrate	-	-	-	-	-	15-20
or potassium nitrate	-	-	-	-	-	or 30

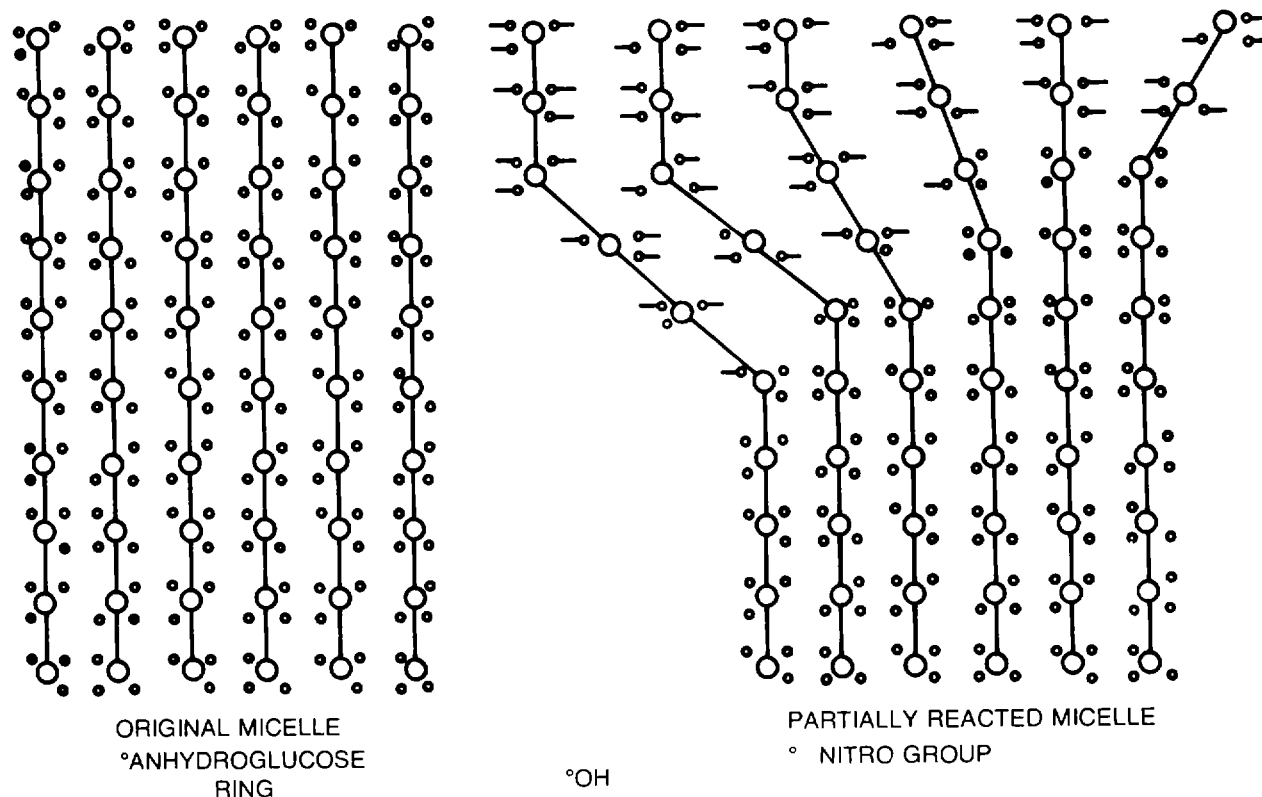

Figure 8-4. Nitration of cellulose.

About 1,500 pounds of mixed acid are placed in a stainless steel nitrator at a temperature of 30°C. The nitrator is equipped with two vertical agitators revolving in opposite directions that impart motion toward the center. Approximately 32 pounds of cellulose are added. The paddles of the agitator are designed to immediately draw the cellulose below the surface of the acid, away from the fume exhaust line. The addition of the cellulose requires about four minutes; agitation is then continued for twenty minutes. Nitration is exothermic, so provisions must be made to prevent the temperature from rising above 300°C. When nitration has been completed, the slurry is discharged through a valve in the bottom to a centrifuge, called a wringer, where most of the mixed acid is removed. The composition of the spent acid can be adjusted if the acid is to be reused in nitration. The acid-wet, crude nitrocellulose is then forked through an opening in the bottom of the wringer into a drowning basin where rapid submersion in cold water takes place. The nitrocellulose must then be stabilized and purified. High nitrogen nitrocellulose can be prepared in the following additional ways. Guncotton wetted with 25 percent water can be nitrated to 14 percent nitrogen content by a mixed acid containing either 60 percent nitric acid, 20 percent acetic acid, and 20 percent acetic anhydride or 50 percent nitric acid, 25 percent acetic acid, and 25 percent acetic anhydride. This process yields nitrocellulose with 14 percent nitrogen of low viscosity which is suitable for military use. Other nitrating agents may be used to produce different percentages of nitrogen. Another method of nitration is to heat concentrated nitric acid to form N_2O_5 vapors which are passed over cellulose in the shape of paper rolls. This process yields a 14 percent nitrogen content.

(5) Removal of the impurities in the raw nitrocellulose is critical to obtain a product with suitable stability. Acids and other impurities are absorbed on the fibers of the nitrocellulose and are hard to remove. The first step in the process, called the sour boil, is carried out in large cypress wood tubs equipped with ducts for heating and circulating water at approximately 100°C. During the first two hours, the acidity of the water is adjusted to 0.05 to 0.50 percent, calculated to H_2SO_4 . Pyrocellulose and pyroxylin are subjected to 40 hours of boiling treatment with three changes of water during this period. Guncotton is subjected to 60 hours of boiling treatment followed by two five-hour boiling treatments with a change of water after each treatment. The next

step in the process is pulping. Because cellulose fibers are tubular, having capillary channels running through them, part of the impurities present in guncotton are included in these channels and cannot be removed unless the fibers are cut into very short fragments. This operation is done in an apparatus called a beater, or Jordan engine similar to that employed in the paper industry. The beating operation is carried out with a large volume of water with just enough sodium carbonate solution added to preserve a slightly alkaline reaction to phenolphthalein. Beating is continued until the nitrocellulose has been reduced to the desired degree of fineness, as determined by a settling test. After the slurry from the beater has been settled and decanted, the nitrocellulose is subjected to poaching. Poaching consists of one four-hour, one two-hour, and two one-hour boiling treatments with settling, decantation, and the addition of fresh water after each treatment. In the four-hour boiling treatment, sodium carbonate equaling 0.5 percent of the weight of dry nitrocellulose is added. The poaching treatment is followed by not less than two washes with cold water, each wash consisting of agitation of the nitrocellulose with fresh water for at least half an hour. The next step in the process is called screening. Uniformity of characteristics is difficult to obtain in the various batches of nitrocellulose. To ensure uniform characteristics in the final product, portions of batches having high nitrogen content and high viscosity are mixed with portions having low nitrogen content and viscosity. The resulting mixtures possess properties intermediate between those of the individual batches. The mixed slurry is fed through a distributor which spreads the nitrocellulose uniformly on packer screens. The screen, with 0.02 inch slots, is vibrated mechanically and the properly pulped nitrocellulose passes through the screen into collecting boxes. If a blended nitrocellulose is desired, blending is the next step in the manufacturing process. Each blending unit consists of two tubs, equipped with propeller type agitators, interconnected so that the contents are kept in constant circulation. The receiving tub, or high tub, is filled with slurry from the screening operation so that the overflow discharges into the low tub. When the low tub is partially full, a circulating pump is started and part of the slurry is returned from the low tub to the high tub. This process is continued for 6 to 7 1/2 hours after which time a sample is tested for nitrogen content and solubility in a solution of 2 parts ether and 1 part alcohol. The last step in the

manufacture of nitrocellulose is wringing. Nitrocellulose from the screening or blending process is placed in a centrifugal wringer with a perforated brass basket lined with a 24 mesh copper screen. The basket revolves at 950 rpm for about seven minutes. The wrung nitrocellulose, with a moisture content of about 31 percent is stored in rustproof metal cans with tight fitting covers.

(6) Dry nitrocellulose is very sensitive to impact, friction, heat, and spark and is never handled in quantity in the United States. The results of impact sensitivity tests for all types of nitrocellulose are approximately 8 centimeters, which indicates nitrocellulose is 460 percent as sensitive as TNT or about the same as mercury fulminate and lead azide. Rifle bullet impact tests indicate nitrocellulose to be very sensitive with 100 percent of the trials yielding complete detonations. While the five second explosion temperature test value for pyrocellulose (170°C), blended nitrocellulose (200°C), and guncotton (230°C) are not particularly low, the rapid rate of decomposition of the material at temperatures greater than 100°C and the exothermicity of such decomposition make the material very sensitive to ignition by a spark. Nitrocellulose can be detonated even when wet. A mixture of 60 percent nitrocellulose and 40 percent water confined in a steel barrel sometimes is detonated by a stick of dynamite. The frequency of detonation is greater when the water is frozen. Tests have shown that nitrocellulose uniformly wetted with 35 percent ethanol will also detonate, on occasion, when initiated with dynamite.

(7) The brisance of nitrocellulose, as determined by the sand test, is directly comparable with TNT but less than tetryl. The brisance of nitrocellulose increases with increases in the nitrogen content. The rate of detonation of guncotton with a nitrogen content of 13.45 percent and density of 1.2 grams per cubic centimeter is 7,300 meters per second; greater than that of TNT. As nitrocellulose propellants can be detonated as well as burned, their brisance values are high. Trauzl lead block tests show guncotton (13.2 to 13.4 percent nitrogen) to be 136 to 147 percent as powerful as TNT and the ballistic mortar test indicates guncotton is 118 percent as powerful as TNT.

(8) The great care taken in the purification of nitrocellulose is due to the necessity for removing impurities that are much less stable than the nitrocellulose. Cellulose sulfate is unstable with respect to heat and moisture. Propellants made from nitrocellulose containing even comparatively small amounts of such esters give decreased 134.5°C heat

test values and deteriorate more rapidly. The nitrates of oxidized cellulose are also objectionable and cause increased instability of nitrocellulose if not removed during the purification process. Elevated temperature tests show that even nitrocellulose of high purity is much less stable than most of the noninitiating military high explosives. The stability of pyrocellulose and blended nitrocellulose is 35 minutes, minimum, by the 65.5° KI test and 30 minutes, minimum, by the 134.5°C heat test. Figure 8-5 shows the DTA and pyrolysis curves for nitrocellulose. Vacuum stability tests indicate the stability of nitrocellulose decreases with increasing nitrogen content. For nitrocellulose with a nitrogen content of 12 percent, 5.0 cubic centimeters of gas are evolved in 48 hours at 120°C. In the LLNL reactivity test, 1.0 to 12 cubic centimeters of gas are evolved per .25 grams of sample. Nitrocellulose appears to undergo very slow decomposition even at ordinary temperatures. The rate of decomposition increases 3.71 times with each 10°C increase in temperature. The presence of moisture increases the rate of decomposition considerably and the presence of free acid or alkali has an even more pronounced effect. Rates of decomposition of pyrocellulose under various conditions are shown in table 8-2.

Table 8-2. Decomposition of Nitrocellulose

Decomposition medium	Percent available nitric acid liberated per hour at -	
	50°C.	97.5°C.
Heat	0.0000045	0.0028
Water	0.0000111	0.0051
0.06 Percent nitric acid solution	0.0000325	
0.035 Percent nitric acid solution	-	0.0088
0.035 Percent sodium carbonate solution	0.0006870	0.1358
95 Percent ethanol	0.0000290	-

From these data, it is apparent that alkali is more effective than acid in causing the deterioration of nitrocellulose. Pyrocellulose is hygroscopic to the extent of 3 percent at 30°C and 90 percent relative humidity. Under the same conditions blended nitrocellulose, 13.15 percent nitrogen, is hygroscopic to the extent of 2.5 percent, guncotton, 13.45 percent nitrogen, to 2 percent, and high nitrogen nitrocellulose, 14 percent nitrogen, to 1 percent.

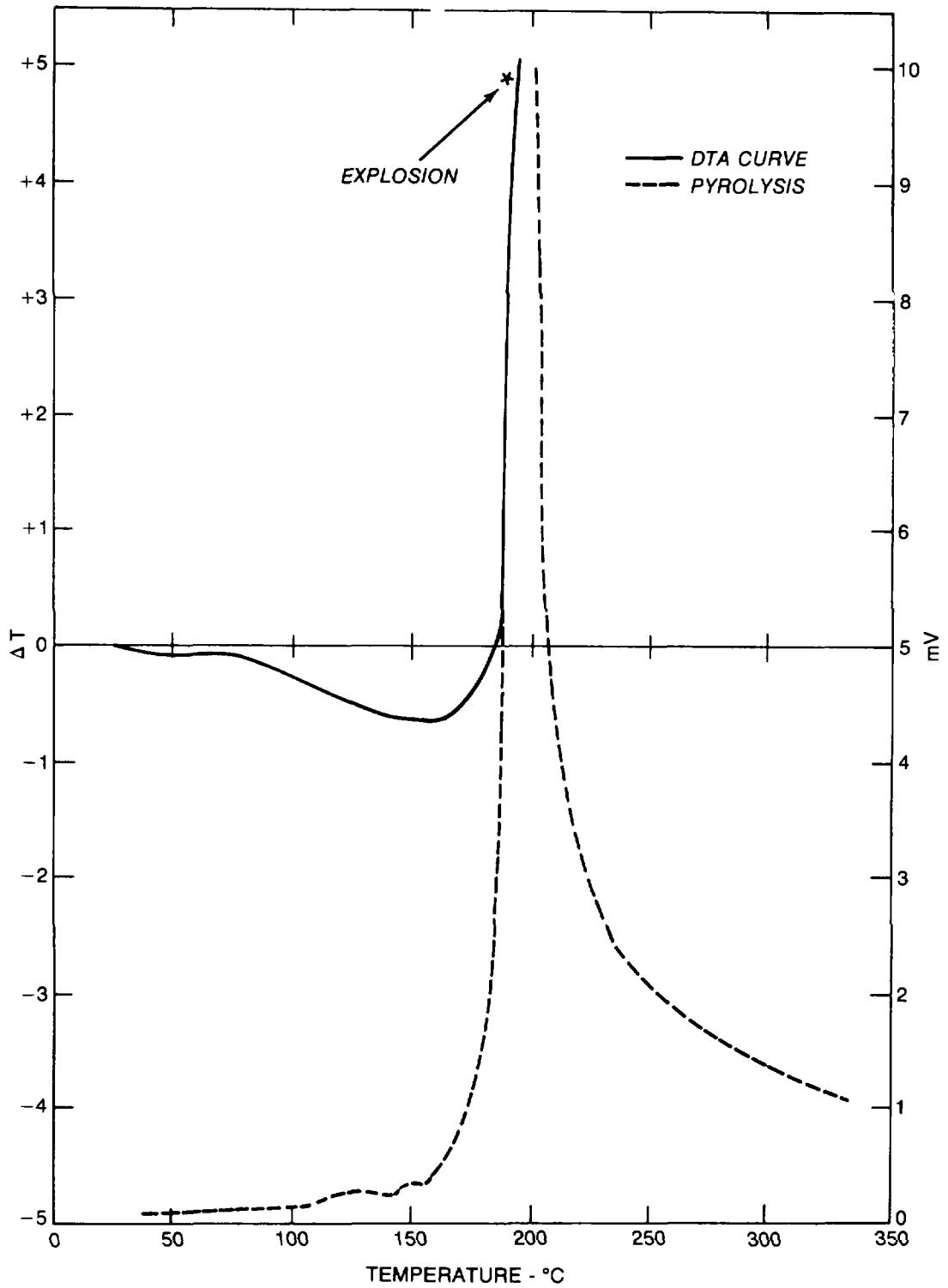

Figure 8-5. DTA curve for nitrocellulose.

(9) Military grades of nitrocellulose are:

	Class	Nitrogen, percent
Grade A	Pyrocellulose	
Type I		12.60±0.10
Grade B	Guncotton	
Grade C		12.60±0.15
Type I	Blended	
Type II		13.35 minimum
Grade D	Pyroxylin	
Grade E		13.15±0.05
		13.25±0.05
		12.20 ±0.10
		12.00±0.10

The maximum allowable ash left after ignition of the nitrocellulose in any grade is 0.4 percent. The minimum percentage that is insoluble in ether alcohol in grades A, D, and E is 99 percent. The solubility limit for grade C in ether alcohol is left to discretion of the contractor manufacturing propellants from the nitrocellulose.

d. Nitroglycerin (NG).

(1) Nitroglycerin, glycerol trinitrate, or 1,2,3-propanetriol trinitrate, shown in figure 8-6, is a clear, colorless, odorless, oily liquid with a theoretical maximum density of 1.596 grams per cubic centimeter. Nitroglycerin has a sweet, burning taste and a molecular weight of 227.1.

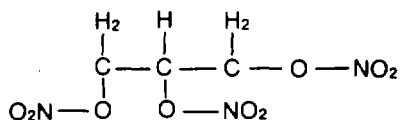

Figure 8-6. Structural formula for nitroglycerin.

(2) Pure nitroglycerin freezes to form dipyramidal rhombic crystals with a heat of crystallization of 33.2 calories per gram. This is a stable form with a freezing point of 13.2°C and melting point of 13.5°C. Under some conditions, glassy triclinic crystals with a heat of crystallization of 5.2 calories per gram are formed. This is a labile form with a freezing point of 2.1°C and a melting point of 2.8°C. The labile form gradually changes into the stable form after a week or two with a heat of conversion of 28 calories per gram. Nitroglycerin has an apparent boiling point of 145°C, but this is merely the temperature at which nonexplosive decomposition becomes vigorous enough to resemble boiling. True boiling takes place at reduced pressure; at 2 torr the boiling point is 125°C and at 50 torr the boiling point is 180°C. Even under high vacuum boiling, however, some decomposition takes place.

(3) Nitroglycerin has a specific gravity value of 1.596 20/15 and a refractive index value of 1.4732 at

20°C. Viscosity values are 0.36, 0.21, 0.094, and 0.068 poise at 20°, 30°, 50°, and 60°C, respectively. The vapor pressure values for nitroglycerin in torr are 0.0013 at 15°C, 0.0015 at 20°C, 0.00177 at 25°C, 0.00459 at 35°C, 0.0075 at 40°C, 0.01294 at 45°C, 0.03587 at 55°C, and 0.06 at 60°C. Decomposition begins at 50° to 60°C. Nitroglycerin is volatile to the extent of 0.11 milligram per square centimeter per hour at 60°C. The specific heat of nitroglycerin is 0.356 calories per gram per degree centigrade between 35°C and 200°C.

(4) The heat of detonation is 1,486 calories per gram for gaseous water and 1,590 for liquid water. One gram/mole of nitroglycerin produces 715 milliliters/163.5 liters. The heat of formation is 90.8 kilocalories per mole.

(5) Nitroglycerin is soluble in one liter of water to the extent of only 0.173, 0.191, 0.228, and 0.246 gram at 20°, 30°, 50° and 60°C, respectively and is essentially nonhygroscopic when exposed to atmospheric humidity. Absolute ethanol dissolves 37.5 and 54 grams of nitroglycerin per 100 grams of solvent at 0° and 20°C, respectively. 96 percent alcohol dissolves 40 grams per 100 grams of solvent at 20°C. Carbon tetrachloride dissolves 20 milliliters per liter and trichloroethylene dissolves 20 parts per 100 parts of solution. Carbon disulfide at room temperature dissolves only 12.5 grams per liter of solvent. Hot ethanol and nitroglycerin are miscible in all proportions. Nitroglycerin is miscible in all proportions with ether, acetone, glacial acetic acid, ethyl acetate, benzene, toluene, phenol, nitrobenzene, chloroform, ethylene chloride, and nitric esters such as glycol dinitrate. Nitroglycerin can be used as a solvent for other explosives; 35 grams of dinitrotoluene dissolve in 100 grams of nitroglycerin at 20°C and 30 grams of trinitrotoluene dissolve per 100 grams at 20°C. Nitroglycerin is used extensively in propellant compositions as a gelatinizing agent for nitrocellulose as well as in dynamites and for the shooting of oil wells.

(6) Concentrated sulfuric acid decomposes nitroglycerin resulting in the formation of nitric acid. In the presence of metallic mercury, nitric oxide is formed quantitatively, and this reaction is the basis for determination of the purity of nitroglycerin by the nitrometer method. The reaction between nitroglycerin and aqueous sodium hydroxide is slow because of their immiscibility, but if ethanol is added the reaction is rapid. Sodium nitrate, nitrite, formate, and acetate are produced in this reaction and resinous material, oxalic acid, and ammonia are produced as byproducts. Nitroglycerin is hydrolysed to a very slight extent by water; producing less than 0.002 percent of acidity in 10 days

at 22°C or 0.005 percent of acidity in 5 days at 60°C. An aqueous solution of sodium sulfide decomposes nitroglycerin producing great heat. This reaction can be used for the destruction of waste material.

(7) Nitroglycerin is manufactured by nitrating glycerin with a mixed acid. Several processes are currently used in the United States and Europe. The processes can be generally classified according to whether they are continuous or batch production.

(a) In batch production, high grade glycerol is added to mixed acid that consists of 45 to 50 percent nitric acid and 50 to 55 percent sulfuric acid. The mixed acid is prepared well in advance to allow metallic sulfates to settle out. The metallic sulfates might otherwise interfere with separation of the nitroglycerin. Two important factors determine the proportions in the mixed acid. First, that the ratio of the sulfuric acid to water at the end of the reaction, the dehydrating value of the sulfuric acid or DVS, is maintained between 4.35 and 4.5. The water includes both the water in the original reactants and that produced during the reaction. This ensures that the nitric acid is maintained at a sufficient concentration to ensure completion of the reaction so that completely nitrated products that are subject to exothermic oxidation reactions are not formed. Second, that enough nitric acid is present to drive nitration, which is a reversible reaction, to completion. A slight excess of nitric acid will accomplish this. The reaction between the glycerol and mixed acid is carried out in a nitrator equipped with a mechanical agitator and cooling coils that carry a brine solution of calcium chloride at 20°C. A 6,800 pound charge of mixed acid is placed in the nitrator and the glycerol is added in a small stream. The mixed acid to glycerol ratio, by weight, is between 5.5 and 6.5. If too much glycerol is added, exothermic decomposition and oxidation reactions occur and temperature control becomes difficult. The temperature is maintained at 2° to 3°C by cutting off the flow of glycerol as necessary. If the temperature does rise above 3°C, the contents are drowned in a water tank beneath the nitrator. Stirring must be adequate to prevent freezing on the cooling coils. Stirring is continued for a few minutes after the 50 to 60 minutes required to add the glycerol. Then the nitroglycerin is allowed to separate completely. The lower layer of spent acid is drained off to be recycled or otherwise disposed of, and the nitroglycerin is run off into a neutralizer. An initial 40°C water wash removes most of the acid. Then a wash with a 2 to 3 percent sodium carbonate solution neutralizes the residual acid. Washing with water is continued until the water is free of alkali and the nitroglycerin is neutral to litmus. The final step in this manufacturing process is to wash with a

sodium chloride solution to remove any nitroglycerin water emulsion. Moisture content gives the product a milky appearance, but on storage in a heated building, the material becomes clear and the moisture content decreases to 0.4 percent or less. The yield of nitroglycerin is 230 ±5 parts by weight per 100 parts of glycerin.

(b) The chemistry involved in the continuous manufacture of nitroglycerin is basically the same as that described for batch processing except the equipment is designed to allow nonstop production. The advantages of continuous processes are: faster production, better process control, lower labor costs, and, perhaps most important, safety, as a result of the smaller accumulations of nitroglycerin at any given plant location. In the United States the common practice is to nitrate mixtures of glycol and glycerol. The nitration proceeds in the same manner as with pure glycerol.

1 The Schmid-Meissner process (figure 8-7) involves continuous nitration of glycerin or other liquids, such as ethyleneglycol or diethyleneglycol, separation of the nitrated product from spent acid, and purification by neutralization and washing. The stainless steel nitrator is equipped with a motor driven, steel propeller, vertical cooling coils, and an overflow tube to separator. A two way valve, which may be connected to the mixed nitric-sulfuric acid line or may be opened to the drowning tank, is fitted centrally to the bottom of the nitrator. Brine at about -5°C is circulated at a controlled rate around the cooling tubes in the annular space outside the nitrator. As a measured amount, per unit time, of mixed acid is fed in from the bottom, a calculated amount of glycerin is fed in from the top at a level below that of the overflow pipe. The flow of materials into the nitrator is by means of automatically controlled air pressure. The propeller mixes the two liquids and glycerin is nitrated to nitroglycerin. The temperature in the nitrator is not allowed to exceed 18°C. The emulsion of nitroglycerin and spent acid flows off continuously through the overflow to the separator, which is a stainless steel, inclined, rectangular tank provided with a number of vanes, equipped with a bottom draw off valve for spent acid, a sight glass near the top, and a steel neck with overflow pipe for the nitroglycerin. Because of difference in density, the spent acid settles to the bottom of the separator and the nitrated product rises. The withdrawal of acid from the bottom is regulated to keep the separated nitrated product in the top of the separator at a predetermined level. The spent acid is discharged to the acid recovery plant and the nitroglycerin flows by gravity to the base of the first of the washing columns.

Each column consists of superimposed cylindrical glass sections (rings) separated by perforated stainless steel plates and rubber ring gaskets. The nitrated product from the separator enters the bottom of the first washing column, is mixed with cold water and emulsified by means of air injected into the liquid. This also forces the material to rise to the top of the column, where the emulsion overflows into a tank which serves as an intermediate separator. Here the nitrated product rapidly settles to the bottom, and flows to the base of the second wash column. In the second column the separated nitroglycerin is mixed with a hot dilute

solution of soda and ammonia and then emulsified with air. The emulsion flows from the top of the column to another intermediate separator where the nitrated product settles to the bottom and is separated from the soda ash water, which is conducted to waste via settling tanks. Any nitroglycerin held in the tanks is drawn off periodically and rewashed. The nitrated product is subsequently passed through additional wash columns and separators until the desired stability is attained. Finally the purified product is passed through a flannel filter bag before being caught in a lead tank for storage and use.

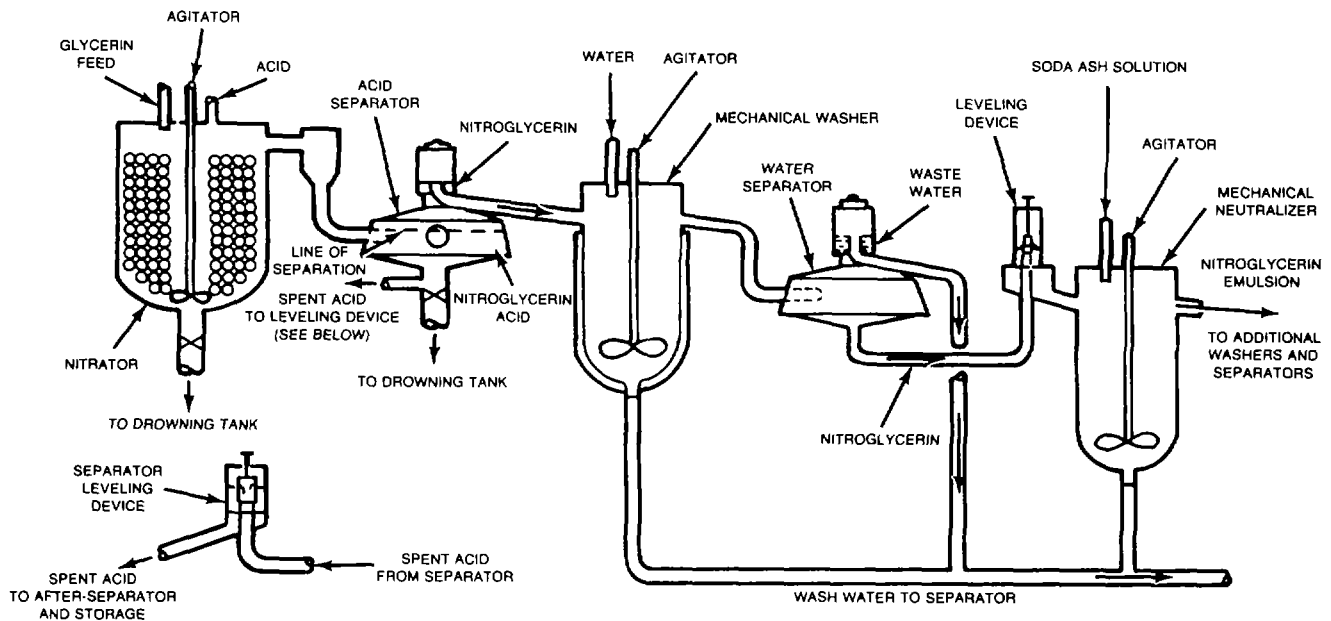

Figure 8-7. Schmid-Meissner continuous method for manufacturing nitroglycerin.

2 The Biazzi process (figure 8-8) is similar to the Schmid-Meissner, but is considered to be safer because of the smaller amount of nitroglycerin in the system at a given time. The nitrator is a small, cylindrical, stainless steel vessel provided with a bank of helical cooling coils. A high speed, shrouded, impeller-type agitator forces the nitrating acid up through the bank of coils and down through the cylindrical space in the center of the coils. The fresh, mixed acid and the material to be nitrated stored in large scale tanks or bins enter, in controlled ratio, at the top of the nitrator, striking the liquid at such a point in the vortex that the feed is immediately thrust beneath the surface and carried down through the central space formed by the coils. The mixture then spirals back, up and out, through the banks of cooling coils and a portion is carried off by the overflow pipe which leads to the separator. The flow of mixture past the coils is counter to the flow of cooling brine circulating through the coils. Because of this arrangement which permits rapid reaction through rapid heat absorption, the mixed acid can be stronger than that used in the Schmid-Meissner process. The cooling coils, agitator, and cover of the nitrator are mounted as a unit separate from the cylindrical body, which can be lowered hydraulically for inspection. The Biazzi acid separator is a stainless steel vessel of the shape shown in the figure. The emulsified mixture of nitrated product and spent acid enters tangentially through the side about midway up and imparts a slight centrifugal action to the upper layer of liquid in the separator. This action helps to break the emulsion and to prevent local overheating. The spent acid flows continuously from the bottom of the separator through a draw off valve, controlled by an adjustable collar, which can be raised or lowered by means of a micro screw attachment. After leaving the first separator, the acid is passed through an after-separator from which some of the nitrated product is recovered. The spent acid leaving the after-separator is usually diluted with water to dissolve traces of dissolved nitrated product. The separated, nitrated product is continuously drawn off from the first separator into a stainless steel wash tank equipped with a cylindrical baffle and an impeller-type agitator. Water is continuously added to the washer and the mixture overflows into a second separator. The nitrated product is drawn from the bottom of the separator and is conducted to the second washer where some soda wash solution is added with agitation. If a high purity nitrated product is required, such as for nitroglycerin used in propellants, the emulsion from the second washer, together with some soda ash solution, is conducted through a battery of three or four washers in which wash waters are running countercurrent to the movement of nitroglycerin. From there the emulsion passes through a series of separators arranged in cascade and is collected in a

storage tank. In cases of overheating, the nitrator and the first separator can be emptied quickly into a drowning tank which is generally filled with water but can be filled with sulfuric acid. The Biazzi process is also used in the manufacture of DEGN and other aromatic and aliphatic nitrocompounds. Only one nitrator is required for mononitration but for higher degrees of nitration more nitrators are added in series. Such nitrations usually employ the spent fortified acid from the higher nitration as the mixed acid for the next lower nitration.

3 The Swedish Nobel Aktiebolaget process for nitrating glycerin consists of an injector nitrator and a centrifugal separator for separating nitroglycerin from spent acid. The mixed acid used in this process is a mixture of about 1.7 parts spent acid and one part conventional, 50 percent nitric and 50 percent sulfuric acids, mixed acid. This mixture contains about 27 percent nitric acid and 10 percent water. Glycerin flow into the injector is controlled by the acid flow through the injector in the same manner that suction is produced by a water aspirator. Thus, if the acid flow is reduced by some equipment malfunctioning, the glycerin flow is automatically decreased. This process, unlike most of the others, operates at a high temperature, about 45° to 50°C. The glycerin or glycerin-glycol mixture is heated to 45° to 50°C before entering the injector. The mixed acid is cooled to 0°C. In the injector the heat of reaction maintains the fluid temperature at 45° to 50°C. Automatic controls give warning or shut down the operation if the temperature rises a few degrees above the normal range. The nitroglycerin acid emulsion enters a cooling system immediately after leaving the injector. The temperature of 45° to 50° is maintained for only about half a second. During the next 80 to 90 seconds the mixture is cooled to 15°C. In the following 30 seconds the nitroglycerin is separated from the spent acid. A continuous centrifugal separator separates nitroglycerin from the spent acid. The centrifuge operates at 3,200 rpm. For a unit with a capacity of 25,000 liters per hour the quantity of nitroglycerin in the separator bowl during operation is only 3.5 kilograms. The separated acid free nitroglycerin is emulsified immediately by a wash jet to form a nonexplosive mixture and is removed continuously from the separator house to the nitroglycerin wash-and-weigh house.

4 Another proposed method is very similar to the Nobel Aktiebolaget process where the reaction is carried out in a tube. The significant difference is that the mixed acid and glycerin are pumped and turbulent flow is maintained in the tube to ensure a complete, rapid reaction. The reactants are then cooled, separated, and washed.

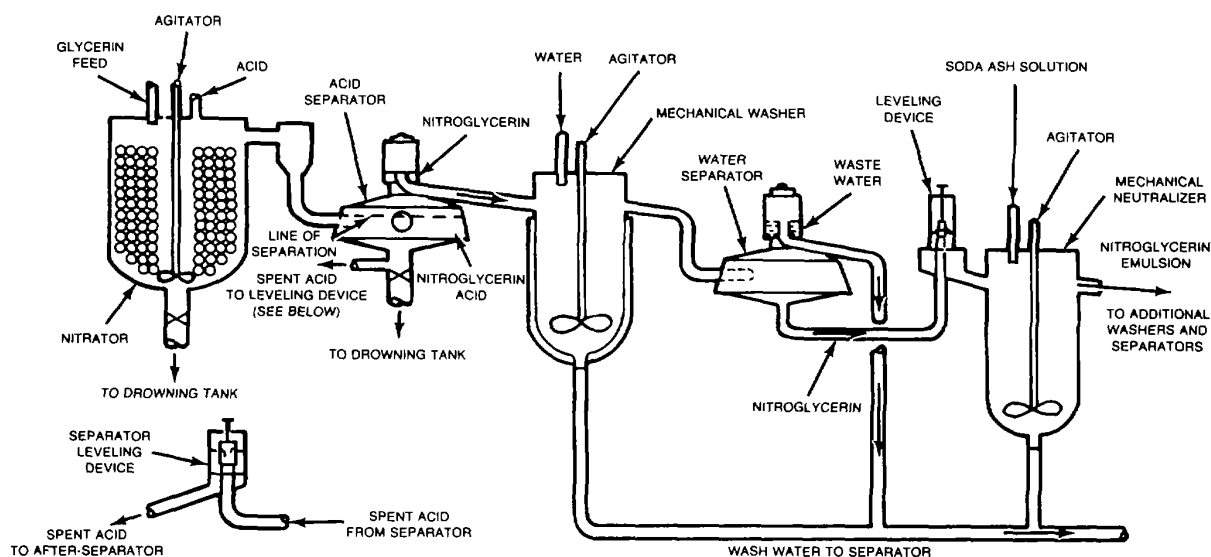

Figure 8-8. Biazzi continuous method for manufacturing nitroglycerin.

(8) There are two grades of nitroglycerin specified for military use. Type I uses grade B glycerin for manufacture. Type II uses partially polymerized glycerin. These two grades must comply with the following requirements:

	Type I	Type II
Moisture content, maximum	0.5 percent	0.5 percent
Acidity or alkalinity, maximum	0.002 percent	0.002 percent
Nitrogen content	18.40 percent, minimum	17.8 percent, minimum 17.9 percent, maximum
82.2°C, KI test, Minimum	10 minutes	10 minutes

The KI test does not measure stability but indicates the presence or absence of trace impurities not found in highly purified nitroglycerin.

(9) The great sensitivity of nitroglycerin is generally recognized. The pendulum friction test indicates nitroglycerin is very sensitive to friction. Impact test results vary with the instrument used, however, they all indicate nitroglycerin is very sensitive to impact. The Picatinny Arsenal impact test shows nitroglycerin is more sensitive than mercury fulminate. The results of impact tests have been found to depend on the area of the impacted nitroglycerin, the smoothness of the two surfaces involved, and the aeration of the nitroglycerin. The tests indicate a force of at least 1000 gram centimeters is necessary when using a five centimeter diameter weight but with a 2.5

centimeter diameter weight a greater force is required. Even the slightest dents in the anvil will greatly increase the sensitivity as measured by an impact test. Detonation is attributed to thermal ignition from compressed gas bubbles with the degree of compression being higher in the area of a dent. An increase in temperature increases sensitivity to impact markedly. Frozen nitroglycerin is much less sensitive than liquid and the liquid increases in sensitivity as the temperature rises. The most sensitive form, however, is when crystals are in contact with the liquid. Many accidents have occurred when frozen dynamite was jarred while being thawed. In general, unconfined bulk nitroglycerin is difficult to ignite by flame or heat, the ease of ignition improving as the nitroglycerin layer becomes thinner. Nitroglycerin may explode instead of igniting if large quantities are subjected to localized, sudden heating. If a very small quantity of the material is contained in a capillary glass tube and this is exposed to a flame, the nitroglycerin detonates with a loud report. When compared with similar values for other explosives, the five second explosion temperature test value of nitroglycerin, 222°C, does not indicate the observed sensitivity to initiation by heat. At 50° to 60°C nitroglycerin liquid or the liquid saturated in filter paper does not explode or ignite from a 13 kilovolt spark from an eight micro farad capacitor. In gap sensitivity tests, blends of 15 percent nitroglycerin and 85 percent inert salts were packed in two identical 30 to 32 millimeter diameter tubes and placed end to end on dry sand a definite distance apart. Detonation of one tube resulted in detonation of the other at maximum gaps for these salts of: NH_4Cl at 25 centimeters, NaCl at 11 centimeters, NaHCO_3 at 10 centimeters. Diammonium sulfate,

diammonium carbonate, chalk, or talc did not transmit the detonation even at zero gap. The particle size of the salts is important. For NaCl the optimum size is 0.10 to 0.12 millimeter in greatest dimension. Nitroglycerin is initiated to detonation by a black powder squib, but not uniformly so. No data are available in connection with the sensitivity of nitroglycerin to initiation by initial detonating agents. However, the fact that 40 percent straight dynamite can be detonated by lead styphnate indicates a high degree of sensitivity, since lead styphnate will not detonate pressed PETN and this is very sensitive to initiation.

(10) Pure nitroglycerin is too sensitive to be transported by common carrier. A mixture of 70 parts of nitroglycerin and 30 parts of acetone by weight is relatively insensitive and sometimes is transported by wagon or truck. Such a mixture can be detonated by a No. 8 blasting cap. Modified Bureau of Mines impact tests of various mixtures gave the sensitivity values shown by table 8-3.

Table 8-3. Impact Sensitivity of Nitroglycerin-Acetone Mixtures

Composition, percent		Impact test centimeters
Nitroglycerin	Acetone	
100	0	16
90	10	23
80	20	41
75	25	60
73	27	64
70	30	100 +

The nitroglycerin in such a mixture can be separated from the acetone by precipitating the nitroglycerin by addition of an excess of water or by evaporating the acetone with a current of air. An emulsion of 87 percent nitroglycerin and 13 percent water that has been stabilized with methyl cellulose also has been found to be sufficiently insensitive to permit safe handling. This mixture is not detonated by a blasting cap.

(11) The detonation velocity of nitroglycerin varies according to the method of initiation. When properly initiated, the normal rate of detonation at a density of 1.60 grams per cubic centimeter is given as 7,700 meters per second. When improperly initiated, the rate can be as low as 1,500 to 2,000 meters per second. The rate of detonation also varies according to the state of the nitroglycerin. In a 22 millimeter inner diameter glass tube with a 7,000 meters per second picric acid fuse, detonation velocities of 9,150 meters

per second, 0 meters per second, and 1,165 meters per second were obtained for the stabile, labile, and liquid forms, respectively. Use of a 20 gram tetryl booster gave 9,100 meters per second for the labile form. Use of 10 to 15 grams of the stabile form as a booster gave 8,750 meters per second for the liquid form. Tests indicate that the brisance of the stabile form is much higher than either the labile or liquid form. The Trauzl lead block compression test indicates nitroglycerin is 115 percent as brisant as TNT while the sand test indicates a value of 120 percent. The temperature of explosion is given as 4,577°C for the decomposition as shown:

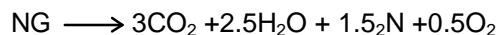

and a resultant pressure of 10,000 atmospheres. Trauzl lead block test results of 390 cubic centimeters, 518 cubic centimeters, and 560 cubic centimeters were obtained for the stabile, liquid, and labile forms, respectively. The Trauzl lead block test value for nitroglycerin is greater than that for any other military explosive. This is in agreement with the correspondingly high heat of explosion value. The ballistic pendulum test values indicate RDX and PETN to be more powerful than nitroglycerin. This can be explained by the fact that nitroglycerin has a ratio of combined oxygen to oxygen required for complete combustion of 105.9 percent, while RDX and PETN have corresponding ratios of 66.7 and 85.7 percent, respectively. In the Trauzl test, the samples are not in contact with air, while in the ballistic pendulum test, air surrounds the sample when placed in the explosion chamber. This would tend to increase the test value for explosives that are less than oxygen-balanced but have no effect on the test value for nitroglycerin.

(12) Nitroglycerin is quite stable at temperatures less than 50°C, as shown by storage tests over a period of years. At higher temperatures, the rate of decomposition increases rapidly, and 100°C vacuum stability test data show that at that temperature nitroglycerin is the least stable of the standard military explosives of the noninitiating type. Nitroglycerin does not cause significant corrosion of metals. This is attributed to the low solubility in water, the stability, and the neutrality of nitroglycerin. Rust markedly increases the decomposition of nitroglycerin, as indicated by 100°C vacuum stability tests. The presence of more than a trace of free acid renders nitroglycerin quite unstable; decomposition with the appearance of red fumes takes place within a few days.

e. *Nitrostarch (NS)*.

(1) Nitrostarch is a mixture of nitrates obtained by nitrating starch. The general formula for starch is $C_6H_{10}O_5$. The structure of starch is the same as for nitrocellulose, as shown in figure 8-3, with the exception that the polymer chains are spiral rather than straight. The starch molecule consists of approximately 1,000 anhydroglucose units. The nitration of starch involves replacement of the hydrogen in the three hydroxyl (OH) groups in the anhydroglucose units with NO_2 groups. A representative formula for the nitrated starch may be written as $C_6H_7(OH)_x(ONO_2)_y$ where $x + y = 3$. The NO_2 groups are distributed randomly along the entire length of the starch molecule, so x and y should be regarded as averages over the entire length of the chain. The following empirical formula can be employed to obtain y as a function of the nitrogen content N :

$$y = 162N / (1400 - 45N)$$

The appearance of nitrostarch is practically the same as the unnitrated starting material. Nitrostarch's solubility characteristics are determined by nitrogen content. With a nitrogen content below 8 percent, nitrostarch is scarcely soluble in a mixture of ether and alcohol. If the nitrogen content is between 8 percent and 12.8 percent, the solubility is complete but with a nitrogen content of over 12.8 percent, nitrostarch is only partially dissolved. For a nitrogen content of 6.4 percent, the solubility is 8.4 percent and for a nitrogen content of 13.1 percent the solubility is 78 percent. In acetone the solubility is complete for a nitrogen content of more than 6.4 percent. In ethyl alcohol the solubility is complete if the nitrogen content is between 10 and 11.5 percent. From a chemical viewpoint, nitrostarch may be considered to be another form of nitrocellulose with the same nitrogen content. Decomposition can be accomplished with sulfuric acid in the presence of mercury. Therefore nitrogen content can be measured by an nitrometer. When dissolved in nitric acid and allowed to stand, nitrostarch is decomposed. As with nitrocellulose, aqueous alkali solutions cause saponification. Nitrostarch has a wide variety of gelatinizing agents and is used rather than nitrocellulose in explosive compositions chiefly as a substitute for nitroglycerin. These compositions have the major advantage of being nonfreezing and not subject to the desensitization that accompanies the freezing of nitroglycerin explosives. Nitrostarch explosives have been used as successfully in the Antarctic and Arctic regions as in temperate climates. There is no standard grade of nitrostarch used for military purposes, but there is a specified commercial grade having a nitrogen content from 12.8 to 13.3 percent.

(2) The methods of production and stabilization of nitrostarch are considered trade secrets, so details are scarce. The starch used is produced from corn or cassava and can be obtained from potatoes. This is purified to some extent by washing with a dilute sodium hydroxide or ammonia solution to remove fats and pectic acid and then washing with water. The starch is then dried so that the moisture content is less than 0.5 percent. Nitrostarch can be prepared by dissolving starch in an excess of nitric acid and pouring this solution into an excess of sulfuric acid to precipitate the nitrostarch as an amorphous powder. This method is uneconomical and hard to control and consequently, not used commercially. The usual preparation methods employ mixed acids. The nitrogen content of the nitrostarch depends on the composition of the mixed acid and on the mixed acid to starch ratio. A ratio of 4 parts mixed acid to 1 part starch is used in one manufacturing process. The starch is added to the mixed acid in a nitrator, the temperature not exceeding 38° to $40^\circ C$. The composition of the mixed acid varies with the degree of nitration desired; an acid for nitration to 12.75 percent nitrogen contains 38 percent nitric acid and 62 percent sulfuric acid. After nitration is complete, the contents of the nitrator are drowned in cold water and the nitrostarch caught on a filter. Nitrostarch is purified by washing with cold water, with the addition of ammonia during the preliminary washing, until all traces of free acid are removed. After separation on a filter or in a centrifugal wringer, the nitrostarch is dried on trays in a dry house, heated to 35° to $40^\circ C$. The drying operation is the most dangerous of those involved in the manufacture of nitrostarch because the dry material is sensitive to ignition by spark and burns with great violence. Nitrostarch can also be prepared via nitration with nitric and phosphoric acids N_2O_5 dissolved in nitric acid; N_2O_5 dissolved in chloroform; or nitric acid with P_2O_5 .

(3) Nitrostarch is slightly less sensitive to impact than guncotton, or about 280 percent as sensitive as TNT. The explosion temperature test value of nitrostarch, $217^\circ C$, is essentially the same as that for nitrocellulose, $230^\circ C$.

(4) The brisance and power of nitrostarch are similar to those of nitrocellulose of comparable nitrogen content. The detonation velocity depends on the nitrogen content. The range for properly detonated nitrostarch is from 1,000 meters per second at 8.9 percent to 6,190 meters per second at 13.4 percent.

(5) Heat tests at 120° and $134.5^\circ C$ indicate nitrostarch is less stable than nitrocellulose; at ordinary temperatures, the two appear to be of similar stability as judged by long term storage tests.

f. *Pentaerythritol Tetranitrate (PETN)*.

(1) PETN is also known as 2,2-bis [(nitrooxy) methyl]-1,3-propanediol dinitrate; penthrite; or nitropenta and may be referred to as TEN. The compound (figure 8-9) is a white solid with a molecular weight of 316.2. PETN has two polymorphs: one with a tetragonal crystalline structure and the other with an orthorhombic crystalline structure. The phase change between the two polymorphs occurs at 130°C. The tetragonal crystals have a density of 1.778 grams per cubic centimeter and the orthorhombic crystals have a density of 1.716 grams per cubic centimeter. Normal manufacturing yields tetragonal crystals. The unit cell dimensions of the tetragonal crystals are $a=9.38$ Angstroms, $b=9.38$ Angstroms, and $c=6.71$ Angstroms. The dimensions for the orthorhombic crystals are $a=13.29$ Angstroms, $b=13.49$ Angstroms, $c=6.83$ Angstroms. There are two molecules per cell in the tetragonal form and four molecules per cell in the orthorhombic form. The interatomic distances have been determined as 1.50 Angstroms for the C-C bonds, 1.37 Angstroms for the C-O bonds, 1.36 Angstroms for O-N bonds, and 1.27 Angstroms for N-O bonds. PETN melts at 141.3°C. The boiling point is 160°C under a pressure of 2 torr; 180°C under a pressure of 50 torr. Under atmospheric pressure at temperatures above 210°C, PETN decomposes rapidly and in some cases detonates. The vapor pressure of solid PETN can be found by the empirical equation:

$$\log p = 16.73 - 7750/T$$

where p is the vapor pressure in millimeters of mercury and T is in degrees Kelvin. The vapor pressure of liquid PETN can be determined by the relationship:

$$\log p = 14.44 - 6352/T$$

The standard heat of formation of PETN is given as 128.7 kilocalories per mole. The heat of detonation is 1.65 kilocalories per gram for liquid water and 1.51 kilocalories per gram for gaseous water. The specific heat is given by the equation $0.239 + 0.008^\circ$ for T in the range of 32°C to 127°C. Two equations are given for the specific heat of PETN as a function of temperature:

$$C = 0.257 + (5.21 \times 10^{-4})T \text{ for } T \leq 140^\circ\text{C}$$

$$\text{and } C = 0.239 + (8.0 \times 10^{-4})T \text{ for } 32^\circ\text{C} < T < 127^\circ\text{C}$$

where C is in units of calories per gram per degree centigrade. The heat of combustion is 618.7 kilocalories per mole and the heat of formation is -110.34 kilocalories per mole. Table 8-4 lists the packing density as a function of loading pressure.

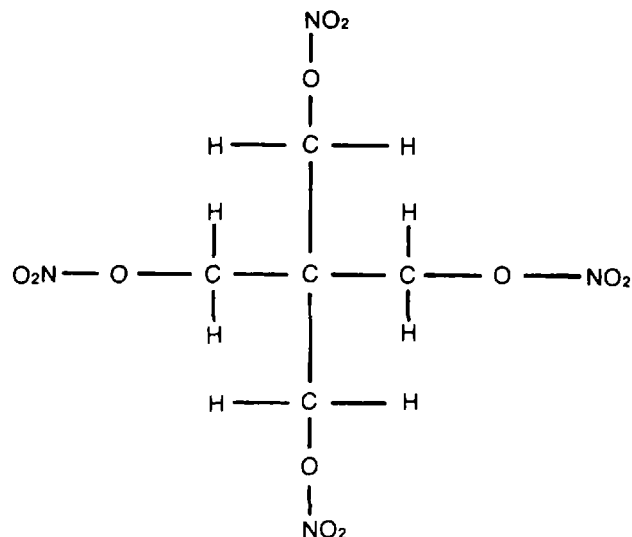

Figure 8-9. Structural formula of PETN.

Table 8-4. Packing Density

Pressure kilograms per square centimeter	Density grams per cubic centimeter
351	1.575
703	1.638
1,406	1.710
2,109	1.725
2,812	1.740

PETN crystals have a scratch hardness of slightly less than 2 on the Mohs scale. PETN is practically insoluble in water; at 25°C and 96°C the solubility is only 0.0043 and 0.018 grams per 100 grams of water, respectively. Table 8-5 lists the solubility of PETN in acetone-water mixtures.

Table 8-5. Solubility of PETN in Acetone Water Mixtures

Amount of PETN, in grams, dissolved in 100 grams of solvent	Acetone concentration				
	55%	70%	80%	90%	92%
	Temperature of solution, °C				
1	41				
2	52				
2.5	-	24.5			
4	62				
5	-	41.5	22		
10	-	54.5	38.5	15	10
15	-	62	48	24.5	20.5
17.5	-	65			
20	-	-	54	34.5	29
25	-	-	59	41.5	34
30	-	-	63	46.5	40.5
35	-	-		51.5	45
40	-	-	-	55	50
45	-	-	-	58.5	54
50	-	-	-	61.5	57.5
55	-	-	-		-60.5
60	-	-	-		62.5

PETN forms eutectic mixtures with a number of compounds as shown in table 8-6.

Table 8-6. PETN Eutectics

Composition	Melting point (C°)
1.5 percent PETN with 98.5 percent nitroglycerin	12.3
20 percent PETN with 80 percent m-dinitrobenzene	82.4
10 percent PETN with 90 percent 2,4-dinitrotoluene	67.3
13 percent PETN with 87 percent trinitrotoluene	76.1
30 percent PETN with 70 percent tetryl	111.3
20 percent PETN with 80 percent mannitol hexanitrate	101.3

(2) PETN is decomposed much more slowly by a boiling 2.5 percent solution of sodium hydroxide than nitrocellulose. Several hours are required for complete decomposition. At 50°C a solution of sodium sulfide decomposes PETN slowly, but decomposition proceeds rapidly in a boiling solution of ferrous chloride. PETN does not reduce Fehling's solution even on boiling. Hydrolysis of PETN takes place in water about 100°C; at 125°C under pressure the reaction proceeds quite quickly. Addition of 0.1 percent nitric acid

enhances the hydrolysis. The main product of hydrolysis is pentaerythritol dinitrate. At temperatures up to about 50°C, dry PETN does not react with copper, brass, aluminum, magnesium, magnesium-aluminum alloys, stainless steel, mild steel, mild steel coated with acid-proof black paint, and mild steel plated with copper, cadmium, nickel or zinc. Wet PETN does not react with stainless steel, and aluminum is affected only slightly after long periods of storage. However copper, brass, magnesium, magnesium-aluminum alloys, mild steel, mild steel coated with acid-proof black paint, and mild steel plated with cadmium, copper, nickel or zinc are affected. PETN is used in the explosive core of industrial detonating fuses, in the charge of commercial blasting caps, and as the entire explosive charge in exploding bridge wire detonators. PETN is also used in certain plastic bound explosives and in a mixture with TNT called pentolite.

(3) While PETN can be manufactured by treating pentaerythritol with nitric acid and adding concentrated sulfuric acid to complete the separation of the PETN, manufacture in the United States has been with nitric acid alone:

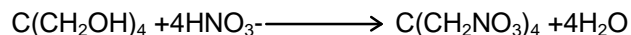

This is accomplished by adding approximately 75 pounds of pentaerythritol to 350 pounds of 98 percent nitric acid in a nitrator, and stirring and cooling the acid continuously. The pentaerythritol is added at a rate that, with an initial acid temperature of 18°C, the temperature increases to and is maintained at 22° to 23°C. Stirring and cooling are continued for 20 minutes after addition of the pentaerythritol is complete. The acid solution then is added, with agitation, to about 850 pounds of cold water in a drowning tank. The precipitated PETN is caught on a glass-cloth filter and washed with water. The precipitate is then mixed with 1,300 gallons of cold water containing 2 pounds of sodium carbonate and separated from the slurry by refiltering. After being washed again with water, the PETN is dissolved in 440 pounds of 98 percent acetone heated to 50°C and containing 14 ounces of ammonium bicarbonate. The solution is filtered and the PETN precipitated by the addition of cold water to the acetone solution. The precipitated solid is caught on a filter and washed with water to remove acetone. The water wet material is considered the final product. Drying is done at the point of use. The yield of PETN by this process is approximately 93 percent of the theoretical. The spent acid resulting from the drowning operation contains approximately 20 percent nitric acid. This is recovered and concentrated. The mother liquor, resulting from the precipitation of PETN, contains approximately 25 percent acetone, which also is recovered. The purity of PETN produced by this process depends upon that of the pentaerythritol nitrated. Ordinarily, the pentaerythritol used for nitration contains 2 or 3 percent of dipentaerythritol and a small amount of tripentaerythritol:

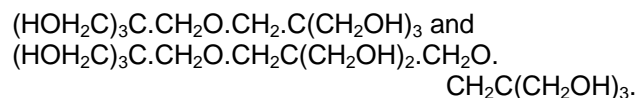

PETN produced on a large scale contains corresponding amounts of the hexanitrate and octanitrate of these compounds, respectively.

(4) One grade of PETN is used for military purposes and this complies with the following requirements:

Color: White or light buff.

Moisture¹: Minimum, 40 percent.

Melting point: 141°±1°C.

Nitrogen content: Minimum, 17.50 percent.

Acetone insoluble¹: Maximum, 0.10 percent

Insoluble particles²: None

Acidity or alkalinity²: Maximum, 0.01 percent

120°C vacuum stability test: Maximum, 5 milliliters of gas from 2.3 grams in 20 hours.

Granulation:

Through sieve No.	Class A	Class B	Class C	Class D
30 Minimum	-	-	95	100
80 Minimum	100	-	-	-
100 Maximum	-	-	-	20
100 Minimum	85	96	-	5
140 Maximum	55	-	-	-
200 Maximum	30	80	30	-
200 Minimum	-	65	-	-

¹Not applicable to class C PETN used in coprecipitated pentolite.

²Not applicable to class C PETN.

Class A PETN is used in detonating fuses and boosters; class B is used in priming compositions; class C is used in the manufacture of pentolite; and class D is used in blasting caps and detonators. Pure PETN has a nitrogen content of 17.72 percent and a melting point of 141.3°C. The military grade is approximately 99 percent pure. The insoluble particles requirement is important because of the sensitivity of PETN and the known effect of gritty material in increasing sensitivity. The acidity or alkalinity requirement is important since the presence of as little as 0.01 percent of either has been found to accelerate the deterioration of PETN markedly. The granulation requirements are those found optimum for specific uses of PETN.

(5) PETN is not as sensitive to impact as nitroglycerin or nitrocellulose, but is slightly more sensitive than RDX and distinctly more so than tetryl. Experiments using a five kilogram weight dropped one meter onto a 15 milligram sample of polycrystalline PETN show the physical changes that occur before initiation. The layer of PETN compresses to about 0.1 millimeter thick. After about 10 microseconds, lateral spreading stops and jetting occurs at 150 meters per second. The initially opaque layer of PETN becomes gradually translucent in an additional 10 to 15 microseconds and completely transparent in 15 to 20 microseconds. The transparency and rapid mobility of the PETN is associated with surface fusion and then melting of the entire sample. About 25 microseconds after the lateral spreading has stopped, the jetting velocity has increased to 300 meters per second and five microseconds after that several hot spots develop simultaneously. The exact mechanism of how the hot spots form is controversial and no generally satisfactory explanation has been put forward. The hot spots are points where deflagration has started. Initially, the deflagration proceeds at several tenths of a meter per second. The products of gaseous combustion raise the pressure of the reaction region and accelerate the rate of deflagration. At the same time, the products of hot combustion penetrate into unreacted regions to produce new ignition sites and a further pressure increase, accelerating deflagration even more. At about 5 to 15 millimeters from the point of initiation, the velocity of the flame front has increased to several hundred meters per second. The flame front drives a compression wave into the unreacted material. When this compression wave attains a velocity of about 700 to 800 meters per second, there is a sharp increase in the propagation velocity to about 1000 meters per second. Depending on the condition of the explosive, this low velocity detonation can propagate over considerable distances or can go over into a normal detonation whose propagation velocity is determined by the density and dimensions of the PETN layer. One condition that can cause acceleration of the detonation velocity to normal

is going from a region of 90 percent crystal density to one of 80 percent crystal density. Initiation by friction and electrical spark proceeds like initiation by impact after the formation of the hot spots. The maximum nonignition spark voltage and nonignition energy for PETN with a particle size of 2.6 microns is 12000 volts and 0.036 joules, respectively, at 500 micro farads capacitance and a spark gap of 0.005 inches. The energy required to detonate PETN 50 percent of the time is 0.19 and 0.36 joules for brass electrodes with lead foil coatings of 3 and 10 mils, respectively. For a steel electrode, the energy required is 0.1 and 0.41 joules with lead foil coatings of 1 and 10 mils, respectively. The physical condition of the explosive appears to have some influence on the amount of energy required for initiation. The discharge energy required increases with PETN particle size, packing density, water content, circuit inductance, and a decrease in ambient temperature. PETN is not particularly sensitive to electrostatic spark. The electrostatic sensitivity parameters should not be confused with the initiation of PETN by an exploding bridge. The exploding bridge is a wire through which a large current is passed, causing the wire to burst. There is an optimum length for each wire material and a minimum critical volume of explosive that must be detonated to cause initiation. Other factors that enhance the ability of the bridge to detonate PETN are: high power input to increase temperature and pressure, a sustained electrical energy input just after the wire bursts to provide simultaneous electrical and chemical energy contributions during the critical growth to detonation period, and use of wire materials with low boiling points and heats of vaporization for greater heat transfer. Attempts to initiate PETN by normal light have been generally unsuccessful although a few instances of some deflagration have occurred with very intense light. Lasers can be used to initiate PETN. The energy required for initiation increases with increased packing density. PETN five millimeters thick with a density of one gram per cubic centimeter can be detonated by a neodymium glass laser with an output at 10600 Angstroms when the beam is focused to produce a power density in excess of 0.08 megawatts per square millimeter. The delay in producing a steady detonation under these conditions is 1.5 to 2.0 microseconds. The delay can be reduced to under 0.5 microseconds if the PETN is coated with a 1000 Angstrom thick layer of aluminum which has been deposited on the sample, and the laser radiation is from 0.5 to 4.2 joules for 25 nanoseconds. Initiation appears to be a thermal process. The laser energy is absorbed rapidly in a thin layer of explosive which produces a shock wave that causes the initiation of the entire sample.

(6) Gap tests indicate the shock sensitivity of PETN increases as packing density increases and as

particle size increases. Gap test results are shown in table 8-8.

Table 8-8. Gap Test Results for PETN

	Density	Percent voids	Sensitivity in millimeters
NSWC small scale gap test	1.775	0.3	6.03
	1.576	11.5	14.38
	1.355	27.9	13.56
LANL small scale gap test	1.757	0.7	5.21
	(pressed)		
LANL large scale gap test	0.81 (raw)	54.2	69.4

Increasing the pressure of an inert gas such as carbon dioxide, nitrogen, or a Nobel gas in the interstices of a PETN pressing decreases shock sensitivity. Increasing the pressure of oxygen increases shock sensitivity. In cast PETN and PETN that has been pressed to 90 percent of the crystal density, substantial reactions take place well behind the shock front that enters the charge and proceeds through the explosive. Stable detonation occurs when the compression waves produced by this reaction catch up with the initial shock front. PETN is less sensitive to friction than RDX and more sensitive than nitroglycerin, as judged by the pendulum friction test. Explosion temperature test values indicate PETN to be as sensitive to heat as nitroglycerin or nitrocellulose. However, the minimum temperature required for the explosion of PETN, 215°C, is greater than that required for the explosion of nitroglycerin, 210°C, and nitrocellulose, 175°C. PETN is more sensitive to initiation than nitrocellulose, RDX, or tetryl, as judged by the sand test. This is shown, also, by the fact that PETN with 35 percent of water present can be detonated by a No. 6 electric blasting cap, whereas RDX fails to explode if more than 14 percent of water is present. PETN is one of the most sensitive of the standardized military explosives.

(7) As measured by the sand test, PETN is between 129 and 141 percent as brisant as TNT. Plate dent tests indicate PETN is 127 percent as brisant as TNT and the lead block compression test indicates a brisance of between 130 and 137 percent of TNT. Table

8-9 lists the detonation velocity of PETN at various packing densities determined experimentally with the confinement indicated.

Table 8-9. Detonation Velocity Versus Density

Density	Detonation velocity	Density	Detonation velocity
(g/cc)	(m/sec)	(g/cc)	(m/sec)
1.773	8,300*	1.27	6,660†
1.765	8,280†	1.26	6,760†
1.765	8,240*	1.09	5,830†
1.763	8,270*	0.55	3,850*
1.762	8,250*	0.436	3,400*
1.762	8,260*	0.241	2,810*
1.51	7,440†	0.201	2,730*
1.51	7,490†	0.185	2,670*

*Unconfined rate stick

†Cylinder test

The following equations, which are in agreement with the data in the table, specify the detonation velocity in kilometers per second as a function of density, p , for the range indicated.

$$\begin{array}{ll}
 D=2.14+2.84p & p < 0.37 \\
 D=3.19+3.7(p-0.37) & 0.37 < p < 1.65 \\
 D=7.92+3.05(p-1.65) & p > 1.65
 \end{array}$$

The diameter of a PETN charge has little effect on the velocity of detonation. The charge diameter below which no detonation can take place (the critical diameter) is only 0.9 millimeters for PETN at a density of one gram per cubic centimeter with 0.025 to 0.1 millimeter particles. The critical diameter becomes smaller as the density of the charge is increased. Since

confinement effects parallel the diameter effects, the detonation velocity of PETN is not greatly affected by confinement for any particular charge size. This is also indicated by table 8-9. Detonation, or Chapman-Jouguet, pressure is shown as a function of packing density in table 8-10.

Table 8-10. PETN Detonation Pressures Versus Density

Density grams per cubic centimeter	Dimensions of PETN: Diameter x length Centimeters (inches) Shock Electric Effect Measurements	Detonation pressure (kbar)
1.764	5 x 1.3 (2 x 0.5)	338
1.763	2.5 x 1.3 (1 x 0.5)	333
1.763	2.5 x 2.5 (1 x 1)	340
1.763	5 x 1.3 (2 x 0.5)	338
1.763	5 x 2.5 (2 x 1)	340
1.762	5 x 2.5 (2 x 1)	339
1.758	2.5 x 2.5 (1 x 1)	333
1.71	2.5 x 2.5 (1 x 1)	309
1.70	2.5 x 2.5 (1 x 1)	307
1.69	2.5 x 2.5 (1 x 1)	304
1.60	2.5 x 2.5 (1 x 1)	266
1.59	2.5 x 2.5 (1 x 1)	259
1.53	2.5 x 2.5 (1 x 1)	225
1.46	2.5 x 2.5 (1 x 1)	198
1.45	2.5 x 2.5 (1 x 1)	208
1.44	2.5 x 2.5 (1 x 1)	199
1.38	2.5 x 2.5 (1 x 1)	173
1.23	2.5 x 2.5 (1 x 1)	138
0.99	2.5 x 1.3 (1 x 0.5)	87
0.95	2.5 x 1.3 (1 x 0.5)	85
0.93	2.5 x 2.5 (1 x 1)	77
0.93	2.5 x 3.8 (1 x 1.5)	72
0.89	2.5 x 2.5 (1 x 1)	71
0.88	2.5 x 2.5 (1 x 1)	68
	Optical (Smear Camera) Measurements	
0.48	3.8 x 2.5 (1.5 x 1)	24
0.30	3.8 x 1.3 (1.5 x 0.5)	24
0.29	3.8 x 2.5 (1.5 x 1)	15
0.27	3.8 x 1.3 (1.5 x 0.5)	5
	Quartz Crystal Measurements	
0.25	4.5 x 2.5 (1.75 x 1)	8
0.25	4.5 x 2.5 (1.75 x 1)	7
0.25	4.5 x 3.8 (1.75 x 1.5)	6

The ballistic mortar test indicates PETN is 137 to 145 percent as powerful as TNT. The Trauzl test indicates PETN is 161 to 189 percent as powerful as TNT. PETN is ranked with RDX and nitroglycerin as the most potent of military explosives.

(8) The products obtained upon detonation of PETN depend on the density of the explosive. The four equations listed in subparagraphs (a) through (d) are valid at the density given. The subscript s refers to soot. The soot is produced in the Chapman-Jouguet region by the reactions:

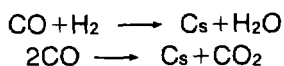

(a) For PETN with density of 1.77 grams per cubic centimeter:

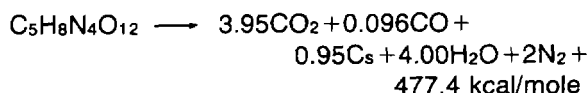

(b) For PETN with density of 1.67 grams per cubic centimeter:

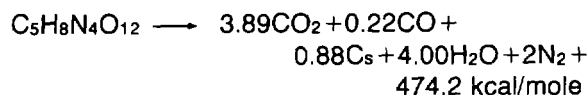

(c) For PETN with density of 1.2 grams per cubic centimeter:

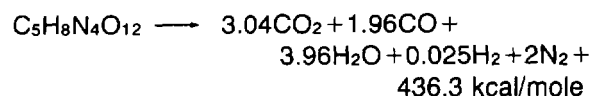

(d) For PETN with density of 1.0 grams per cubic centimeter:

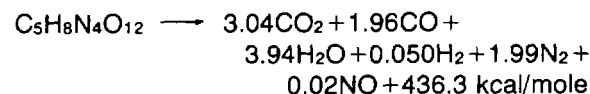

and minor amounts of NH_3 , H, OH and CH_4 .

(9) Vacuum stability tests at 100° and 120°C show PETN to be more stable than nitrocellulose or nitroglycerin at elevated temperatures but distinctly less stable than RDX, tetryl, or TNT. PETN is quite stable at 100°C and can withstand heating at this temperature for 100 hours without significant deterioration. In the LLNL reactivity test 0.10 to 0.14 cubic centimeters of gas are

evolved per .25 grams of sample. Figure 8-10 shows the percentage of PETN decomposition as a function of time and temperature for temperatures over 140°C. The curves were obtained by heating a sample to the indicated temperature for the indicated time then analyzing the remaining PETN. The following six reactions, which take place simultaneously, show the mechanism of thermal decomposition:

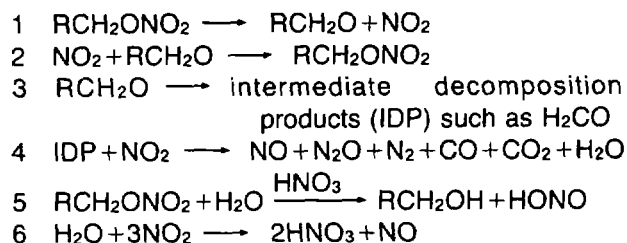

PETN is shown as RCH_2ONO_2 . Storage at 65°C for 20 months does not cause instability or undue acidity; and after 24 months only slightly excessive acidity develops. Figure 8-11 shows the DTA curve and figure 8-12 shows the TGA curve for PETN. When 0.01 percent of free acid or alkali is present, storage for only 15 months at 65°C results in rapid acceleration of the rate of decomposition. Since RDX, tetryl, and TNT are even more resistant to storage at 65°C, PETN is not as suitable for storage and use under tropical conditions.

g. Triethylene Glycoldinitrate (TEGN).

(1) This explosive is also referred to as TEGDN. The compound (figure 8-13) is a light yellow, oily liquid with a nitrogen content of 11.67 percent, a molecular weight of 240.20, and an oxygen balance to CO_2 of -66.6 percent. The melting point of the solid is -19°C. Other characteristics of the liquid are: refractive index, 1.4540; viscosity at 20°C, 13.2 centipoises; vapor pressure at 25°C, less than 0.001 torr; volatility at 60°C, 40 milligrams per square centimeter per hour; and density, 1.335 grams per cubic centimeter. At constant pressure, TEGN's heat of combustion is 3428 calories per gram, heat of explosion is 725 kilocalories per kilogram, and heat of formation is -603.7 kilocalories per kilogram. TEGN is very soluble in acetone, ether, and a solution of 2 parts ether and 1 part ethanol. TEGN is soluble in carbon disulfide and slowly soluble in water. The primary use of TEGN is as a gelatinizing agent for nitrocellulose in propellants, but TEGN can also be used as a component in a liquid explosive, a plasticizer in the fabrication of flexible explosive sheets, and as a plasticizer in pyrotechnic flares.

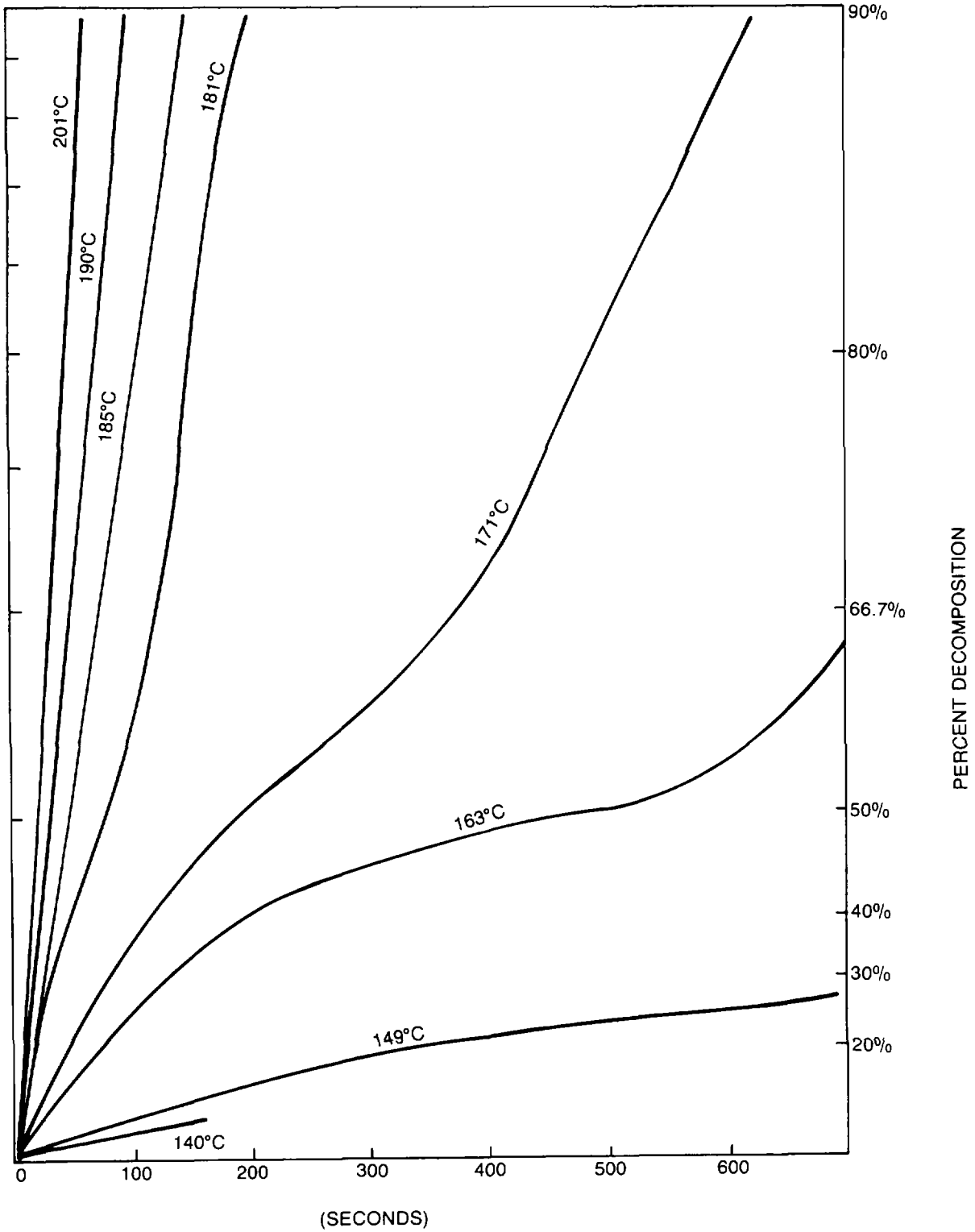

Figure 8-10. Thermal decomposition of PETN.

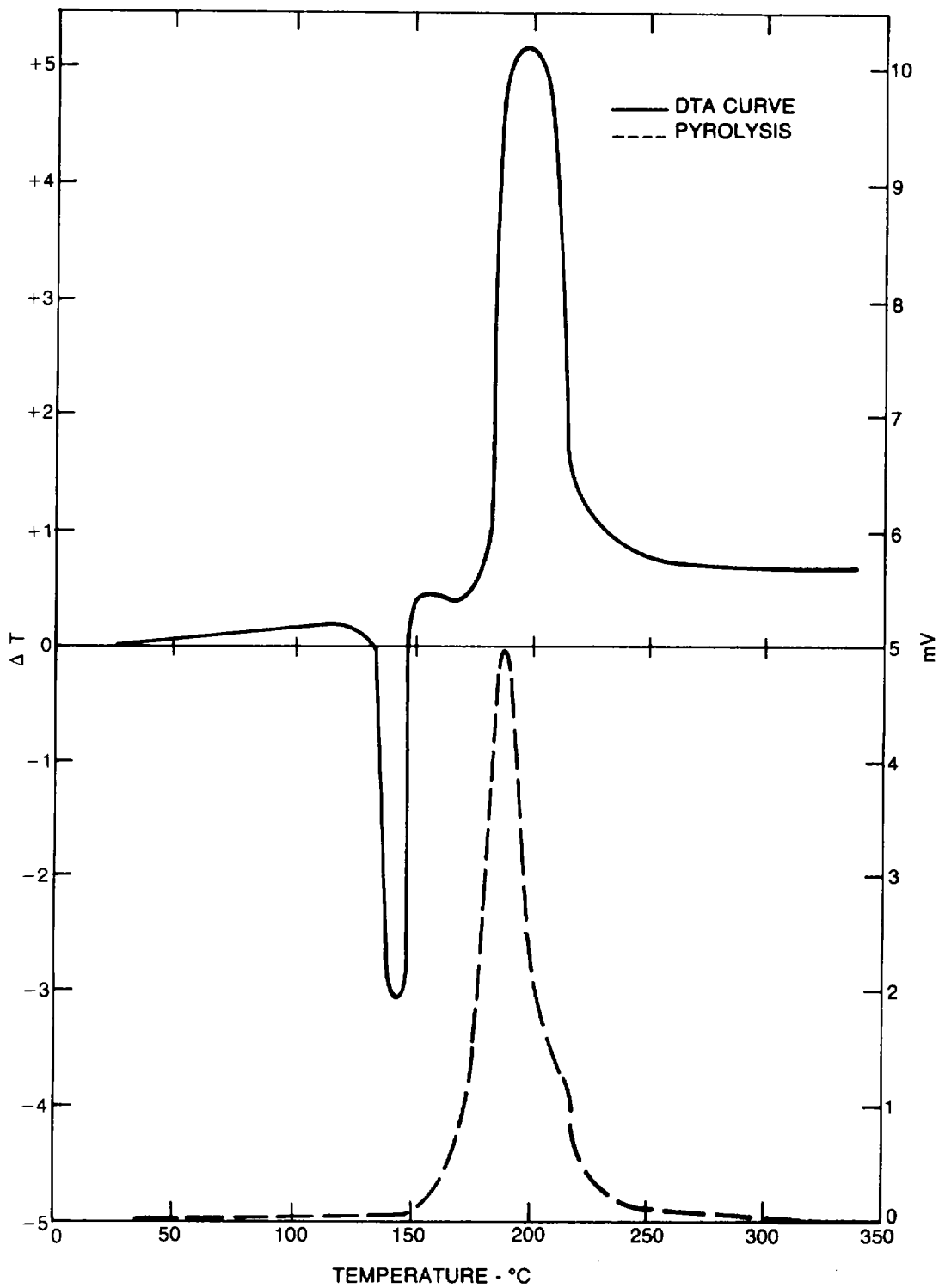

Figure 8-11. DTA curve for PETN.

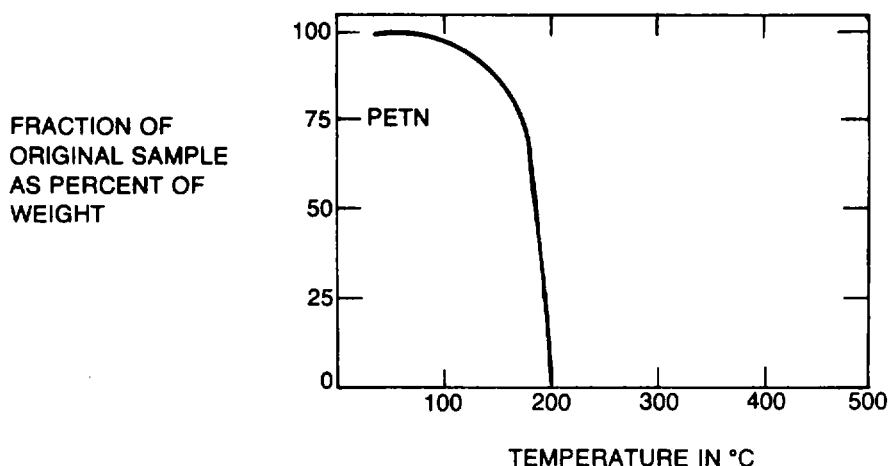

Figure 8-12. TGA curve for PETN.

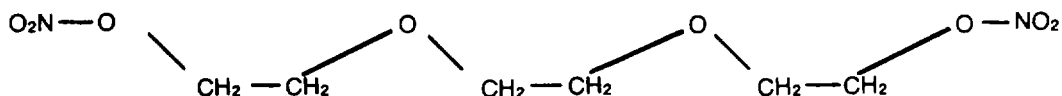

Figure 8-13. Structural formula for TEGN.

(2) TEGN is prepared by the nitration of triethylene glycol. The laboratory procedure for the production of TEGN is given here. The actual manufacturing procedure is by the Biazzi process, discussed under nitroglycerin. The triethylene glycol is purified by fractional distillation under vacuum in an 18 inch Vigreux fractionating column. The assembly as a whole is equivalent to 4.5 theoretical plates. The distillation is conducted using a 5 to 1 reflux ratio, at a pot temperature of approximately 180°C and a take-off temperature of approximately 120°C. The purified triethylene glycol is carefully stirred into a mixed acid that consists of 65 percent nitric acid, 30 percent sulfuric acid, and 5 percent water that is maintained at $0 \pm 5^\circ\text{C}$. The mixture is stirred and held at $0 \pm 5^\circ\text{C}$ for 30 additional minutes and then drowned by pouring over a large quantity of ice. The TEGN is extracted three times with ether and the combined extract is water washed until the pH is about four, then shaken with an excess solution of sodium bicarbonate, and further washed with

a 1 percent sodium bicarbonate solution until the washings are colorless. The ether solution is then water washed until the pH is seven. The solution is then carefully separated from the excess water, treated with chemically pure calcium chloride to remove the dissolved water, and filtered. The ether is removed by bubbling with dry air. The yield is 1.34 grams of TEGN per gram of triethylene glycol, 84 percent of theoretical. The nitrogen content of different batches can vary from 11.60 to 11.69 percent with 11.67 percent the calculated value. A modification that allows continuous rather than batch nitration is to dissolve the triethylene glycol and mixed acid separately in dichloromonofluoromethane, CH_2Cl_2 or freon 21, and then mix the two solutions. A sufficient quantity of CH_2Cl_2 must be used to maintain the temperature at 11°C and to ensure a safe degree of dilution of the solution. The dispersant is evaporated and the TEGN is recovered. The yield of this process is 74 percent.

(3) TEGN is unaffected in the pendulum friction test with the metal and fiber shoe. The Bureau of Mines impact test indicates a sensitivity of over 100 centimeters and the Picatinny Arsenal impact test indicates 109 centimeters. The five second explosion temperature test value is 225°C.

(4) The 100°C heat test, with losses of 1.8 percent and 1.6 percent for the first and second 48 hour periods, respectively, indicates TEGN is much more stable than nitroglycerin but considerably less stable than all other standard explosives. No explosions occur in the 100 hour observation period. The vacuum stability test results, 45 milliliters of gas in 40 hours at 100°C and 0.80 to 0.99 milliliters of gas in eight hours at 120°C, indicate that TEGN is more stable than PETN, slightly less stable than RDX, and much less stable than TNT.

(5) TEGN is insensitive to detonation. No detonation occurs in samples placed in relatively light steel tubing with a diameter of 3.175 centimeters at a density of 1.33 grams per cubic centimeter. When heavily confined, the detonation velocity is less than 2,000 meters per second, or 30 percent of TNT. The 200 gram sand test indicates a brisance of 30.6 percent of TNT, with 14.7 grams of sand crushed. TEGN's deflagration point is 195°C.

(6) TEGN is extremely toxic and should be considered a potent poison when absorbed through the skin or ingested. Tests with rabbits indicate 21 millimoles per kilogram of body weight causes death in two to three weeks when absorbed through the skin. A level of intraperitoneal exposure of 995 milligrams per kilogram of body weight causes death within 24 hours to 50 percent of the rats treated. TEGN, when selectively applied, can also inhibit the nerve functions in rats.

h. *1,1,1 Trimethylolethane Trinitrate (TMETN).*

(1) This explosive is also known as metriol trinitrate and is sometimes referred to as MTN. The compound (figure 8-14) is a slightly turbid, viscous oil with a nitrogen content of 16.41 percent and a molecular weight of 255.15. TMETN has a melting point of -3°C and an apparent boiling point of 182°C, but this is merely the temperature at which decomposition becomes vigorous enough to resemble boiling. Other properties of the liquid are a density of 1.47 grams per cubic centimeter at 22°C and a refractive index of 1.4752 at 25°C. TMETN is practically insoluble in water. Less than 0.015 grams dissolved per 100 grams of water at up to 60°C. TMETN is soluble in alcohol and many other organic solvents. At 60°C TMETN's volatility is 24 milligrams per square centimeter. The heat of formation is 422 calories per gram at constant volume and 446 calories per gram at constant pressure. The heat of combustion is 2,642 calories per gram at constant volume with the water being

liquid. In an acid bath, TMETN is hydrolyzed to the extent of 0.018 percent in 10 days at 220°C and 0.115 percent in 5 days at 60°C. TMETN can be used as a flash and erosion reducing additive in propellants and an ingredient of commercial explosives. TMETN alone does not gelatinize nitrocellulose unless the temperature is raised to 100°C, which would be dangerous. But if mixed with only 8 percent of metriol triacetate, gelatinization takes place at 80°C. When TMETN is mixed with nitroglycerin, the mechanical properties of double-base cast propellants are improved. Combinations with triethylene glycol dinitrate are used as plasticizers for nitrocellulose.

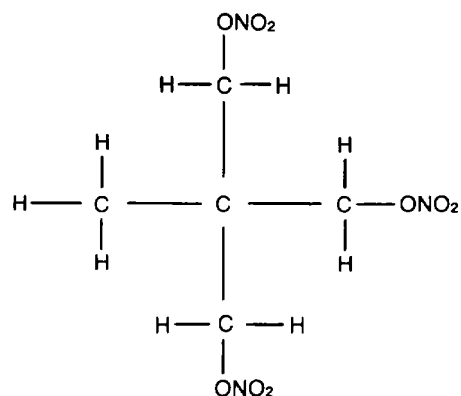

Figure 8-14. Structural formula for TMETN.

(2) One method for the manufacture of TMETN is to feed 50 kilograms of finely powdered metriol into a nitrator provided with cooling coils and an agitator. The nitrator contains 175 kilograms of mixed acid that consists of 65 percent nitric acid and 35 percent sulfuric acid. The nitration time is about 20 minutes at 20°C after which the contents of the nitrator are allowed to set for 15 minutes. The TMETN separates from the spent acid and is decanted and then washed at 40°C with an aqueous solution of soda and then with water. The yield is almost 100 kilograms of TMETN with a nitrogen content of 16.32 to 16.36 percent.

(3) The Bureau of Mines impact apparatus indicates TMETN is as sensitive as nitroglycerin, with a drop height of four centimeters for a two kilogram weight. The five second explosion temperature test value is 235°C and TMETN detonates with both the metal and fiber shoe in the pendulum friction test.

(4) TMETN is 91 percent as brisant as TNT with 43.7 grams of sand crushed in the sand test. The Trauzl test and ballistic mortar test indicate TMETN to be 140 percent and 136 percent, respectively, as powerful as TNT.

(5) The stability of TMETN is not very satisfactory as indicated by the vacuum stability and heat tests. In the 100°C heat test, a 2.5 percent weight loss is reported in the first 48 hours and 1.8 percent in the second 48 hours. No explosions occur in the first 100 hours. In the 100°C vacuum stability test, 1.9 cubic centimeters of gas are evolved in the first 40 hours. At 25°C TMETN is hygroscopic to the extent of 0.07 percent with 90 percent relative humidity and 0.14 percent at 100 percent relative humidity.

8-3. Nitramines. Compounds in this class are prepared by N-type nitration in which a nitro group is attached to a nitrogen atom of the compound being nitrated.

a. *Cyclotetramethylenetetranitramine (HMX).*

(1) HMX is also known as: octahydro-1,3,5,7-tetranitro-1,3,5,7-tetrazocine; 1,3,5,7-tetranitro-1,3,5,7-tetrazacyclooctane; cyclotetramethylene tetranitramine; or octogen. HMX (figure 8-15) is a white, crystalline solid with a nitrogen content of 37.84 percent, a theoretical maximum density of 1.905 grams per cubic centimeter, a nominal density of 1.89 grams per cubic centimeter, a melting point of 285°C, and a molecular weight of 296.17. There are four polymorphs of HMX: an alpha, beta, gamma, and delta form. Each polymorph has a range of stability and there are differences among them in physical properties such as density, solubility, and refractive index. The most common polymorph is the beta form. The term HMX without an alpha, gamma or delta qualifier refers to the beta form throughout the rest of this text. The crystalline structure of beta HMX is monoclinic with a density of 1.903 grams per cubic centimeter. The unit cell dimensions are $a=6.54$ Angstroms, $b=11.05$ Angstroms, and $c=8.70$ Angstroms. Beta HMX is stable to about 102°C to 104.5°C, when the crystalline structure is converted to the alpha form. The crystals of the alpha form are orthorhombic with a density of 1.82 grams per cubic centimeter. The unit cell dimensions are $a=15.14$ Angstroms, $b=23.89$ Angstroms, $c=5.91$ Angstroms. At approximately 160°C to 164°C the meta stable gamma form exists. The crystals of the gamma form are monoclinic with a density of 1.76 grams per cubic centimeter. The unit cell dimensions are $a=10.95$ Angstroms, $b=7.93$ Angstroms, and $c=14.61$ Angstroms. Above the 160°C to 164°C range to the melting point, the delta form exists. The crystals of the delta form are hexagonal with a density of 1.80 grams per cubic centimeter. The unit cell dimensions are $a=7.71$ Angstroms and $b=32.55$ Angstroms. The polymorphs may also be prepared by precipitation from solution under various conditions. The beta form is precipitated from a solution of HMX in acetic acid,

acetone, nitric acid, or nitromethane with very slow cooling. The alpha form is precipitated from the same solution with more rapid cooling and the gamma form is precipitated with even more rapid cooling. The delta form is crystallized from solution such as acetic acid or betachloroethyl phosphate, in which HMX is only slightly soluble. Very rapid chilling of the solution is required. This is usually accomplished by pouring small quantities of the solution over ice. Military grade HMX consists only of the beta polymorph. HMX is insoluble in water, but is soluble in the solvents listed in table 8-11 to the degree shown.

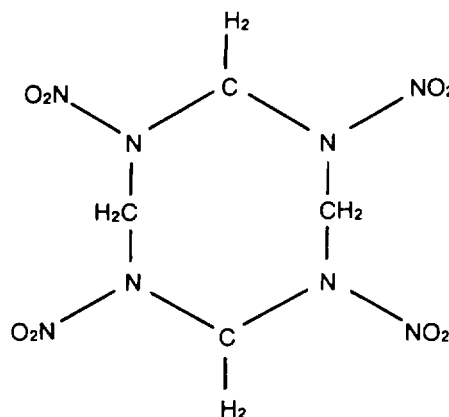

Figure 8-15. Structural formula for HMX.

Table 8-11. Solubility of HMX

Solvent	Grams of HMX dissolved per 100 grams of solution	Temperature °C
Dimethylformamide	4.4	25
Nitrobenzene	0.129	25
1,2-Dichlorethane	0.125	70
Acetic acid	0.0375	25
Acetone	0.96	25
Acetonitrile	1.98	25
Cyclohexanone	2.11	25
Ethylacetate	0.02	25
Ethylbromide	0.02	25
Methylethylketone	0.46	25
Nitroethane	0.172	25
Nitromethane	0.778	25
Triethylphosphate	1.75	25

Table 8-12 lists the solubility of HMX by volume for various solvents.

Table 8-12. Solubility of HMX by Volume

Solvent	Grams of HMX dissolved per 100 milliliters of solution
Gamma-butyrolactone	21.0
Cyclopentanone	1.3
Cyclohexanone	5.2
Acetone	2.2
Acetonitrile	2.0
Nitromethane	1.1
Nitroethane	0.03
Methylisobutylketone	1.8

HMX will also dissolve to the extent of 0.003 grams, 0.002 grams, and 0.144 grams in 100 milliliters of chloroform, carbon tetrachloride, and dioxane, respectively. Carbon disulfide will not dissolve HMX. Table 8-13 lists specific heat values for HMX at various temperatures.

Table 8-13. Specific Heat of HMX

Temperature °C	Calories per gram per degree centigrade
-75	0.153
0	0.228
25	0.248
50	0.266
75	0.282
85	0.288
90	0.290
100	0.295
125	0.307
150	0.315

HMX has a hardness of 2.3 on the Moh's scale, a heat of combustion of 660.7 to 667.4 kilocalories per mole, a heat of formation of 11.3 to 17.93 kilocalories per mole,

a heat of detonation of 1.62 kilocalories per gram with liquid water and 7.48 kilocalories per gram with gaseous water. The vapor pressure of HMX in torr is given by the following equations for the temperature ranges indicated:

$$\log p = 16.18 - 9154/T(K) \text{ for } 97.6^{\circ}\text{C} < T < 129.3^{\circ}\text{C}$$

$$\log p = 15.17 - 8596/T(K) \text{ for } 188^{\circ}\text{C} < T < 213^{\circ}\text{C}$$

HMX and RDX are chemically very similar except that HMX is not easily decomposed by alkaline hydroxide. Concentrated sulfuric acid liberates a little more than one third of nitric acid with HMX while with RDX a little more than two thirds is liberated. HMX is used as an explosive charge when desensitized, as a booster charge in admixtures with TNT called octols, and as an oxidizer in solid rocket and gun propellants.

(2) Two grades of HMX are used for military applications. Both grades consist of only the beta polymorph and must meet the following requirements:

	Grade A	Grade B
Purity, minimum:	93 percent	98 percent
RDX content, maximum:	7 percent	2 percent
Melting point, minimum:	277°C	277°C
Acetone insoluble material, maximum:	0.05 percent	0.05 percent
Inorganic insoluble material, maximum:	0.03 percent	0.03 percent
Insoluble particles on US standard 40 sieve:	none	none
US standard 60 sieve:	5	5
Acidity	0.02 percent	0.02 percent

In addition the HMX must meet the following granulation requirements:

Through US Standard	Class 1 Percent	Class 2 Percent	Class 3 Percent	Class 4 Percent	Class 5 Percent	Class 6 Percent
8				100		
12			99 min	85 min		99 min
35				25 ± 15		
50	90 ± 6	100	40 ± 15			90 min
100	50 ± 10		20 ± 10	15 max		65 ± 15
120		90 min				
200	20 ± 6		10 + 10			30 ± 15
325	8 ± 5	75 min			98 min	15 ± 10

(3) To manufacture HMX, a solution of 785 parts glacial acetic acid, 13 parts acetic anhydride, and 17 parts paraformaldehyde is maintained at a temperature of 44°C ± 1°C. All part measurements in this discussion are by weight. The solution is held at that temperature throughout the subsequent steps of the process. Two more solutions are prepared. One consists of 101 parts hexamine and 165 parts acetic acid. The other is prepared by dissolving 840 parts ammonium nitrate in 900 parts of 99 percent or stronger nitric acid. Over a 15 minute period with constant stirring, the hexamine-acetic acid solution, 180 parts of the nitric acid-ammonium nitrate solution, and 320 parts acetic anhydride are added simultaneously, continuously, and equivalently. The mixture is aged for 15 minutes. In the second stage of the reaction, 320 parts of acetic anhydride and 271 parts of the nitric acid-ammonium nitrate solution are added proportionately, then 160 parts of acetic anhydride are added in bulk. The mixture is allowed to age for 60 minutes. Then 350

parts hot water are added and the solution is refluxed for 30 minutes. After cooling to 20°C by adding ice, the water insoluble precipitate is collected and washed with three portions of cold water. The yield of 200 parts HMX is 95 percent of the theoretical and the purity is higher than 90 percent. The product is alpha HMX which is converted to beta HMX by crystallization from boiling acetone, acetonitrile, or cyclohexanone, using equivalent parts of solid and solvent. The recrystallized HMX has a melting point of 278° to 279°C. The recrystallization process also removes any RDX that was formed during manufacturing.

(4) HMX has similar sensitivity to impact and friction as RDX. The Bureau of Mines impact apparatus with two kilogram weight measures 32 centimeters for a 20 milligram sample. In the pendulum friction test, HMX explodes with the steel shoe but is unaffected by the fiber shoe. Table 8-14 shows the gap test results for HMX.

Table 8-14. Gap Test Results for HMX

	Density grams per cubic centimeter	Percent voids	Sensitivity in millimeters
NSWC small scale gap test	1.814	4.7	8.71
	1.517	20.3	11.28
LANL small scale gap test	1.840 (pressed)	3.2	3.43
	1.790 (pressed)	5.8	4.27
	1.20 (coarse)	36.8	8.53
	0.7 (fine crystals)	63	6.45
LANL large scale gap test	1.07	43.7	70.7

The minimum charge of lead azide required for detonation to obtain maximum brisance is 0.30 grams. Explosion temperature test values are 306°C in 10 seconds, 327°C in five seconds, and 380°C in 0.1 second. When HMX is under a compression of 93,082 kilopascals (13,500 pounds per square inch), the explosive can be reliably detonated by a Q-switched laser operating at 6,943 Angstroms. As measured in a differential thermalgraph analysis study, the auto ignition temperature of HMX is 234°C. In the spark sensitivity test with a brass electrode and a sample size of 66.9 milligrams, the energy required for a 50 percent probability of explosion for lead foil thicknesses of 3 and 10 mils is 0.2 joules and 1.03 joules respectively. For a steel electrode, the energy required is 0.12 joules and 0.87 joules for lead foil thicknesses of 1 and 10 mils, respectively.

(5) The sand test indicates HMX is 125 percent as brisant as TNT or about 96 percent as brisant as RDX. The ballistic pendulum test indicates 170 percent of TNT, the ballistic mortar test indicates 150 percent, and the Trauzl test indicates a power of 159 to 165 percent of TNT. The detonation velocity of HMX at a density of 1.89 grams per cubic centimeter is 9,110 meters per second. The following critical diameters were measured for HMX:

HMX/Wax, percent	Density grams per cubic centimeter	Critical diameters
90/10	1.10	6.0 < <i>dc</i> < 7.0
78/22	1.28	7.0 < <i>dc</i> < 8.0
70/30	1.42	8.0 < <i>dc</i> < 9.0

The diameters are given in millimeters. A gelled aqueous slurry of 30 percent HMX will detonate high order. At 25 percent HMX concentration detonation would be partially propagated and at 20 percent concentration the detonation would not propagate. Settled slurries propagate high order detonation at and above 10 percent HMX concentration. At the five percent level, the settled slurry will detonate about one third of the time.

(6) The 150°C vacuum stability test indicates HMX is comparable to TNT in stability, with test values of 0.6 and 2.5 milliliters of gas evolved. The 100°C heat test loss in the first 48 hours is 0.05 percent and in the second 48 hours 0.03 percent. No explosions occur in 100 hours. At 30°C and 95 percent relative humidity, HMX is nonhygroscopic. In the LLNL reactivity test, less than 0.01 cubic centimeters of gas are evolved. The

DTA curve is shown in figure 8-16 and the TGA curve is shown in figure 8-17.

b. *Cyclotrimethylenetrinitramine (RDX)*.

(1) This explosive is also known as: hexahydro-1,3,5-trinitro-1,3,5-triazine; 1,3,5-trinitro-1,3,5-triazacyclohexane; cyclotrimethylene trinitramine; hexogen; cyclonite; or 1,3,5-trinitrotrimethylene-triamine. The compound (figure 8-18) is a white solid with a density of 1.806 grams per cubic centimeter, a nitrogen content of 37.84 percent, and a molecular weight of 222.13. RDX has orthorhombic crystals with a wide variety of habits; from needles when precipitated from HNO₃, to plates when precipitated from acetic acid, to a massive form when precipitated from nitroethane or acetone. The unit cell dimensions are a=13.18 Angstroms, b = 1 1.57 Angstroms, and c = 10.71 Angstroms, and there are eight molecules per cell unit. On the Moh's scale RDX has a scratch hardness of 2.5. Other properties of pure RDX include a specific heat as shown in table 8-15 and a heat of combustion at constant pressure of 2,307.2 calories per gram. The heat of formation value is + 14.71 kilocalories per mole. RDX has an extremely low volatility.

Table 8-15. Specific Heat of RDX

Temperature °C	Calories per gram per degree
20	0.298
40	0.331
60	0.360
88	0.384
100	0.406
120	0.427
140	0.446

Packing density as a function of pressure is shown in table 8-16.

Table 8-16. RDX Packing Density

Pressure kilopascals	Pressure pounds per square inch	Density grams per cubic centimeter
34,475	5,000	1.52
68,950	10,000	1.60
137,900	20,000	1.68
172,375	25,000	1.70
206,850	30,000	1.72

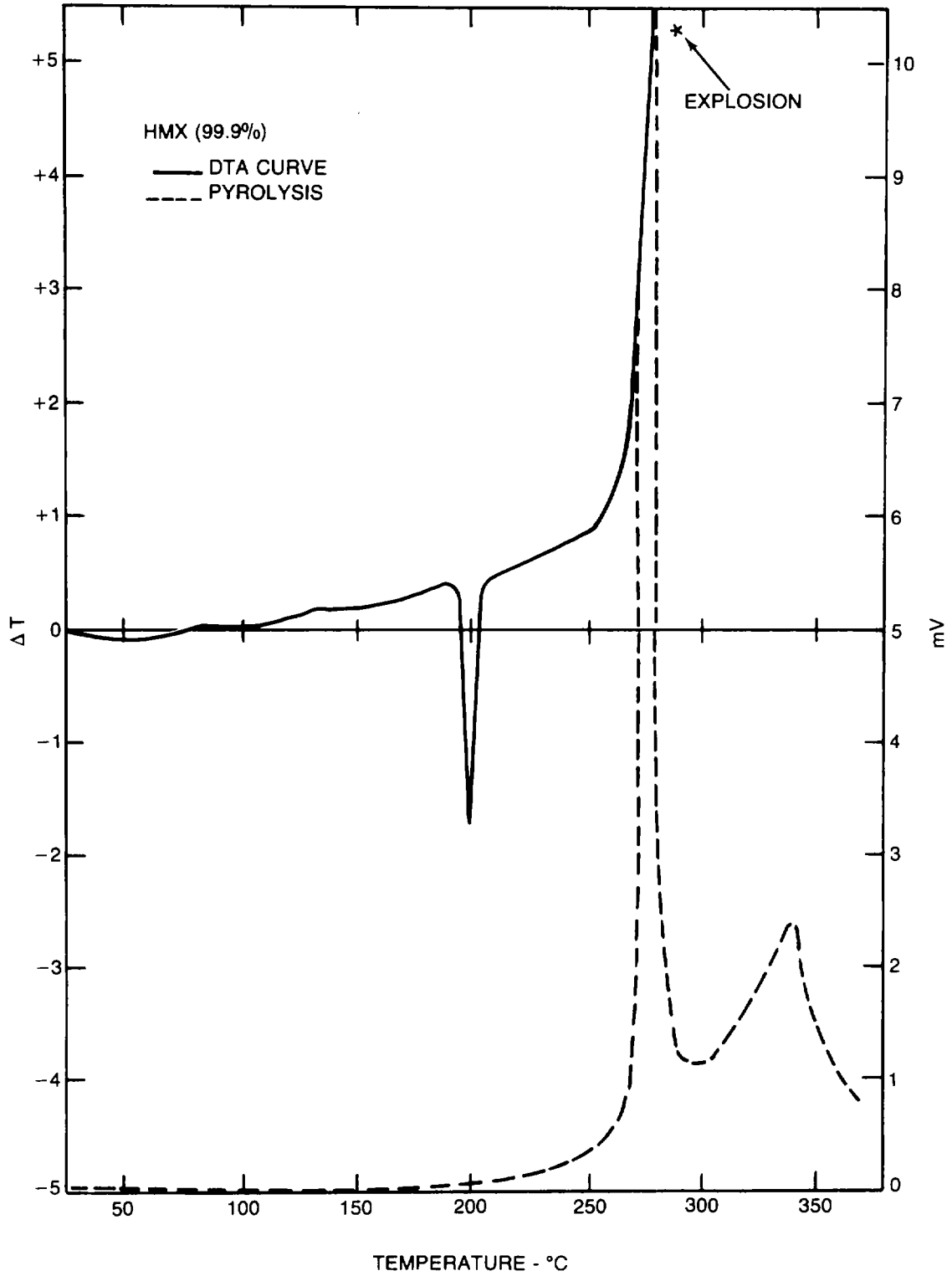

Figure 8-16. DTA curve for HMX.

RDX does not blend with or gelatinize nitrocellulose. With nitroglycerin, RDX forms an explosive plastic mass. Table 8-17 lists the solubility characteristics with TNT.

Table 8-17. RDX-TNT Solubility

Temperature °C	Grams of RDX dissolved per 100 grams of TNT
81	4.5
85	4.7
90	5.0
95	5.8
100	6.5
105	7.3
110	8.2

The eutectic mixture is 4.16 percent RDX at 79°C. Table 8-18 lists the solubility of RDX in various solvents. There is considerable divergence in the solubility data for RDX taken from different sources in the literature, probably due to the different methods and conditions used in making the determinations, the difference in purity, and the difference in physical state of the RDX tested.

Therefore, the values given in table 8-18 are only approximate. The coefficient of cubical expansion between 20°C and 100°C is 0.00025 cubic centimeters per gram per degree centigrade. RDX has a heat combustion of 501.8 to 507.3 kilocalories per mole at constant volume with liquid water. The heat of formation is 14.7 kilocalories per mole. The heat of

detonation is 1.62 kilocalories per gram with liquid water and 1.48 kilocalories per gram with gaseous water. RDX detonates according to the empirically determined equation:



The temperature developed on explosion is 3380°C. There are two grades specified for RDX: types A and type B. Type A contains no HMX and type B has a constant impurity of from 8 to 12 percent HMX. Types A and B are produced by different manufacturing processes. Type A RDX melts between 202°C and 203°C; type B RDX melts between 192°C and 193°C. The vapor pressure of RDX is given by the equation:

$$\log p = 11.87 - 5850/T(K) \quad \text{for } 55.7^\circ\text{C} < T < 97.7^\circ\text{C}$$

Pure RDX is used in press loaded projectiles but not in cast loaded projectiles because of extensive decomposition at the melting point. Cast loading is accomplished by blending RDX with a relatively low melting point substance. Compositions in which the RDX particles are coated with wax are called Composition A, in mixtures with TNT, Composition B, and blends with a nonexplosive plasticizer, Composition C. Straight RDX is used as a base charge in detonators and in some blasting caps, and as an oxidizer in specialized gun propellant.

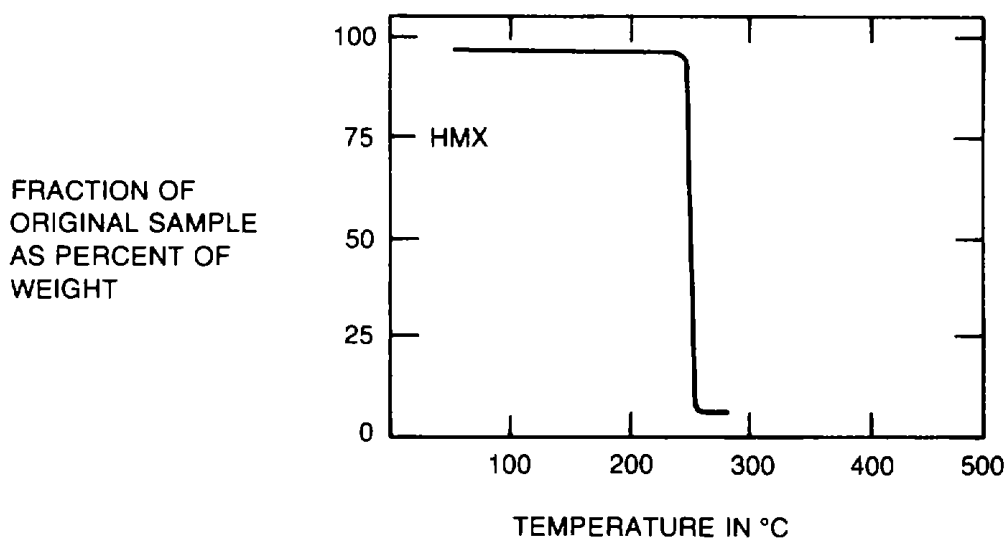

Figure 8-17. TGA curve for HMX.

Table 8-18. Solubility of RDX in Various Solvents

Solvent	Grams RDX per 100 grams of solution at						
	0°C	20°C	30°C	40°C	60°C	80°C	100°C
Acetic acid (50%)			0.12	-	0.50	1.25	-
Acetic acid (100%)	-	-	0.41	-	1.35	2.60	-
Acetic anhydride	-	4.0	4.80	6.0	9.30	-	-
Acetone	4.2	6.8	8.40	10.3	15.3	(at 58)	-
Acetonitrile	-	-	12.0	16.2	24.6	33.0	-
Alcohol, ethyl	0.04	0.10	-	0.24	0.60	1.20	-
Benzene	-	0.05	0.06	0.09	0.20	0.40	-
Carbon tetrachloride	0.0013	0.0022	0.0034	0.007	-	-	-
Chlorobenzene	0.20	0.33	0.44	0.56	-	-	-
Chloroform	-	0.015	-	-	-	-	-
Cyclohexanone	-	12.7 (at 25°)	-	-	-	-	25 (at 97°)
Cyclopentanone	-	-	11.5 (at 28°)	-	-	-	37 (at 90°)
Dimethylformamide	-	25.5	27.3	29.1	33.3	37.7	42.6
Ether, dethyl	-	0.055	0.075				
Beta-ethoxyethyl acetate	-	1.48	1.55	1.9	3.4		
Isoamyl alcohol	0.02	0.026	0.04	0.06	0.21	0.50	1.33
Methanol	0.14	0.235	0.325	0.48	1.06	-	-
Methyl acetate	-	2.95	3.30	4.10	6.05 (at 52°)	-	-
Toluene	0.016	0.02	0.025	0.05	0.125 (at 52°)	0.295	0.64
Trichloroethylene	-	0.20	0.21	0.22	0.23 (at 52°)	-	-
Trinitrotoluene (TNT)	-	-	-	-	-	4.4	7.0
Water	-	0.005	-	0.025 (at 50°)	-	-	0.28

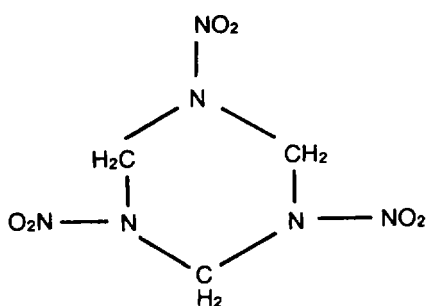
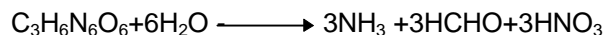

Figure 8-18. Structural formula for RDX.



In sulfuric acid solution the nitric acid oxidizes the formaldehyde to formic acid while being reduced to nitrous acid. RDX dissolved in cold, concentrated sulfuric acid decomposes when the solution is allowed to stand. Reduction of RDX dissolved in hot phenol yields methylamine, nitrous acid, and hydrocyanic acid; but if solid RDX is suspended in 80 percent ethanol and reduced, both hydrolysis and reduction take place and the products are methylamine, nitrous acid, ammonia, and formaldehyde. With diphenylamine and sulfuric acid, RDX gives a strong blue color. RDX dissolves, without decomposing, in concentrations of up to 70 per-

(2) RDX is hydrolyzed slowly when treated with boiling, dilute sulfuric acid or sodium hydroxide according to the reaction:

cent nitric acid and may be recovered from solution by dilution with water. Hot or cold hydrochloric acid does not attack RDX. Complete decomposition can be obtained by heating RDX with equal parts of $\text{Ca}(\text{OH})_2$ for four hours at 60°C . RDX decomposes slowly when heated at 60°C with a one tenth normal solution of sodium hydroxide for five hours, but rapidly when heated with a normal solution of sodium hydroxide. When RDX is placed in an alkaline solution, decomposition occurs. The products of that decomposition which have been isolated are: nitrogen gas, ammonia, nitrates, nitrites, formaldehyde, heramine, and organic acids such as formic. When mixed with oxides of heavy metals, such as iron or copper, RDX forms unstable compounds which may undergo decomposition and cause ignition of mixtures at temperatures as low as 100°C .

(3) Type A RDX is manufactured by the nitration of hexamethylenetetramine which is obtained by the reaction of formaldehyde and ammonia. The process is accomplished by slowly adding one part by weight of hexamethylenetetramine to 11 parts of 100 percent nitric acid, the temperature of which is maintained at 30°C or less while being stirred vigorously. The reaction proceeds according to the equation:

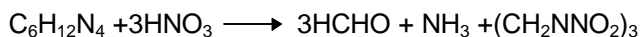

The formaldehyde, HCHO, liberated by the reaction is oxidized by the nitric acid if the mixture is allowed to stand or is warmed. After being cooled to 0°C , the mixture is stirred for 20 minutes more and then drowned in ice water. As a result of the rupture and degradation of the hexamethylenetetramine molecule, numerous aliphatic and cyclic nitrocompounds are formed that are present in crude RDX. The crude RDX is caught on a filter and washed with water to remove most of the acid. Removal of all but a trace of acid is important and purification is accomplished by grinding the wet material then treating with boiling water or by recrystallizing from cyclohexanone or acetone. Production of type B RDX is based on the following reaction:

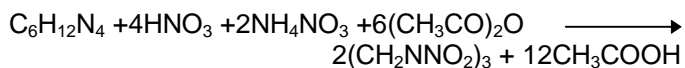

The hexamethylenetetramine is nitrated to RDX by the nitric acid and, as indicated for the production of type A RDX, three moles of formaldehyde are produced. The formaldehyde reacts with the ammonium nitrate in the

presence of the acetic anhydride, $(\text{CH}_3\text{CO})_2\text{O}$, to form hexamethylenetetramine, which is nitrated by the nitric acid to form the second mole of RDX. The HMX impurity is not shown. The yield of the type B reaction is greater than for the reaction using nitric acid alone. Other methods for producing RDX include a process of nitrating hexamethylenetetramine by nitric acid in the presence of phosphorous pentoxide with a yield of 90 percent of theoretical. Nitration by some processes in the presence of ammonium salts such as $(\text{NH}_4)_2\text{SO}_4$ can increase yields. Yields of 65 percent, 80 percent and 91 percent were obtained using no ammonium salt, ammonium nitrate, and ammonium sulfate, respectively. Another possible method of manufacture uses nitrogen pentoxide dissolved in inert, nonaqueous solvents such as hydrocarbons or chlorinated hydrocarbons to nitrate hexamethylenetetramine. The equation for the reaction would be:

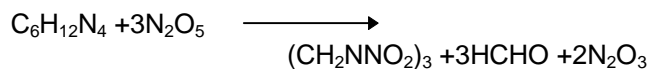

The yield for this method is claimed to be 89 percent. A proposed method for the production of type A RDX consists of oxidizing the compound 1,3,5-trinitroso-1,3,5-triazacyclohexane, which is obtained from hexamethylenetetramine, HCL, and NaNO_2 . Oxidization with hydrogen peroxide and nitric acid yields as an intermediate 1-nitroso-3,5 dinitroso-1,3,5 triazacyclohexane which is converted on further treatment with hydrogen peroxide and nitric acid into RDX having a melting point of 205°C .

(4) Type A and type B RDX are equally sensitive to impact, friction, heat, and initiation. This is due to the fact that HMX, the chief impurity in type B RDX, has sensitivity characteristics that are very similar to those of RDX. Impact tests indicate RDX is 300 percent as sensitive as TNT. Temperature has a marked effect on the sensitivity of RDX. Impact tests of a sample of type A RDX at 20° , 88° , and 105°C gave values of 9, 8, and 5 inches, respectively. Granulation also affects sensitivity; the height of fall increases with decreasing particle size. In pendulum friction tests, RDX explodes with the steel shoe but is unaffected by the fiber shoe. When rubbed in an unglazed porcelain mortar, partial deflagration occurs. RDX displays great sensitivity in the rifle bullet impact test, but the test samples partially deflagrate rather than detonate. RDX can be initiated by lead azide or mercury fulminate. Gap test results for RDX are shown in table 8-19.

Table 8-19. Gap Test Results for RDX

	Density grams per cubic centimeter	Percent voids	Sensitivity in millimeters
NSWC small scale gap test	1.717	4.7	7.90
	1.546	14.2	12.01
	1.188	34.1	11.18
LANL small scale gap test	1.735 (hot-pressed)	4.1	4.8 - 5.6
	1.11 (bulk coarse)	38.7	8.86
	1.00 (bulk fine)	44.8	7.82
	0.7 (fine crystalline)	61	6.77

RDX is much less sensitive to an electric spark than tetryl, TNT, or PETN. Using a circuit with a capacitance of 0.0003 millifarads and a test sample of pulverized or crystalline RDX, no ignitions occur at 12,300 volts but local ignitions do occur at 14,950 volts. At elevated temperatures RDX either fumes off and ignites or deflagrates when unconfined. There are no explosions. Some elevated temperature test results are: at 255° to 260°C, five seconds; at 3160C, one second; at 405°C, 0.1 second. Held at 290°C RDX fumes. The flammability index is 278 versus 100 for TNT and 244 for tetryl. The presence of more than 14 percent moisture prevents detonation by a number 6 blasting cap.

(5) Reported sand test results indicate RDX is from 125 to 145 percent as brisant as TNT. Fragmentation tests, with 51 grams of explosive at a density of 1.50 loaded in a 40 millimeter shell, indicate a brisance of 141 percent of TNT. Plate cutting tests indicate RDX is 125 percent as brisant as TNT, while plate dent tests indicate 135 to 141 percent. The equation for detonation velocity is:

$$D = 2.56 + 3.47p$$

where D is in meters per second and p, the density, is in grams per cubic centimeter. Upon detonation, the pressure developed is 12,600 kilograms per square centimeter or 156 percent of TNT. The following were measured for RDX at the densities shown:

RDX/Wax percent	Density grams per cubic centimeter	Critical diameter
95/5	1.05	4.0 < d _c < 5.0
90/10	1.10	4.0 < d _c < 5.0
80/20	1.25	3.8 < d _c < 5.0
72/82	1.39	3.8 < d _c < 5.0

The diameters are given in millimeters. The volume of gas produced at 0°C and 760 millimeters of pressure is 908 liters per kilogram or 132 percent of TNT. Trauzl tests indicate RDX is 151 to 170 percent as powerful as TNT. However, tests against earthworks, masonry, and in underwater explosions indicate a power of close to 200 percent that of TNT. In one test a 25 kilogram charge of RDX in a shell produced a crater in packed earth 12.60 cubic meters in volume. The same amount of TNT under the same conditions produced a crater 6.75 cubic meters in volume. This indicates a power for RDX of 186.5 percent of TNT. The ballistic mortar test indicates a power of 150 to 161 percent that of TNT. These test results indicate RDX is the second most powerful military explosive.

(6) RDX is highly stable. In a one year surveillance test no decomposition occurred at either 65°C or 85°C. When heated for two months at 100°C no decomposition occurred. The 82.2 KI test results are 60 minutes. In the heat tests, the results were: at 75°C, .03 percent weight loss in 48 hours; at 100°C, 0.04 percent weight loss in the first 48 hours, no weight loss in the second 48 hours and no explosions after 100 hours; at 132°C no change occurred in eight hours of heating; and at 135°C there was no acid and no explosion in 300 minutes. A sample of five grams of RDX subjected to the vacuum stability test yielded the following results: in 40 hours at 120°C, 0.9 cubic centimeters of gas evolved and at 150°C, 2.5 cubic centimeters of gas evolved. A sample of five grams of type B RDX with a melting point of 192°C evolved 3.95 cubic centimeters of gas in 40 hours. In the LLNL reactivity test 0.02 to 0.025 cubic centimeters of gas were evolved. The DTA curve for RDX is shown in figure 8-19 and the TGA curve is shown in figure 8-20.

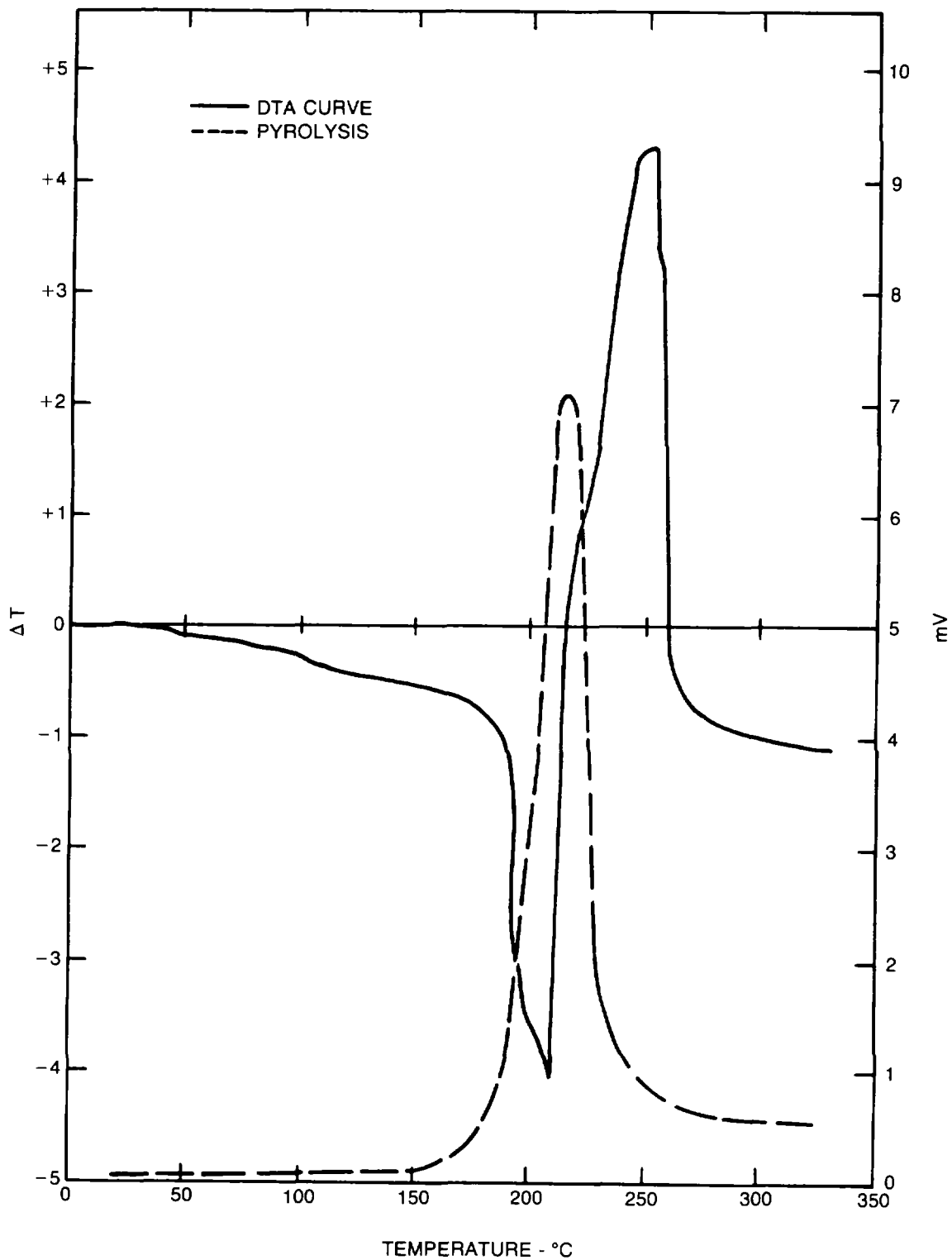

Figure 8-19. DTA curve for RDX.

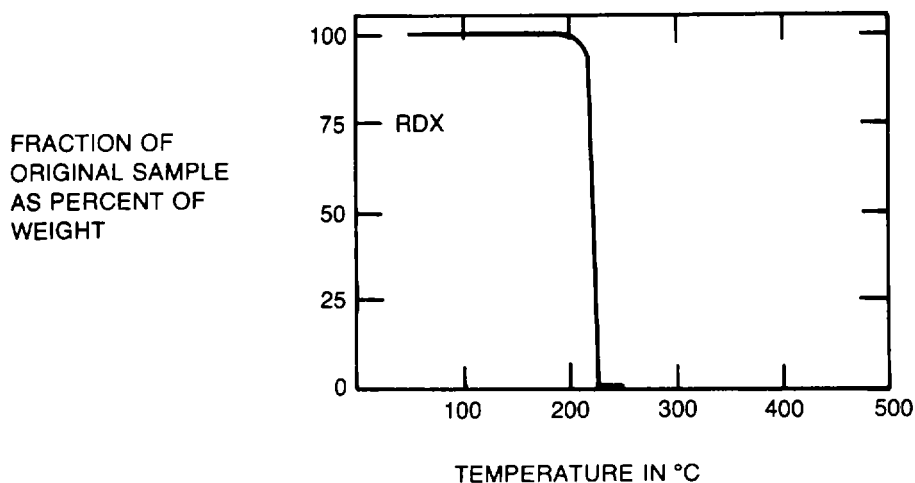

Figure 8-20. TGA curve for RDX.

(7) In the United States and England, RDX is stored wetted with water. In Germany and Japan it is stored dry. RDX does not cause corrosion of aluminum or stainless steel, even in the presence of moisture. Dry RDX causes no corrosion of and RDX with 0.5 percent moisture causes only slight corrosion of nickel or zinc. Dry or damp RDX causes very slight corrosion of copper, brass, mild steel, or cadmium.

(8) Table 8-20 lists the requirements for military grade RDX for the United States government.

Table 8-20. Types of RDX

Properties	Type A	Type B
Melting point, °C (min)	200.0	190.0
Acetone insoluble (max)	0.05	0.05
Inorganic insoluble (max)	0.03	0.03
Insoluble particles retained on US standard sieve No. 60, particles (max)	5	5
Acidity, percent (max)	0.05	0.02

Type A RDX is produced by the nitric acid process: type B is produced by the acetic anhydride process. Granulation requirements are listed in table 8-21.

Table 8-21. Granulation Requirements for RDX

Through US standard sieve No.	Class (% of material passing sieve)							
	A	B	C	D	E	F	G	H
8	-	-	-	100	-	-	-	-
12	-	-	99*	-	-	-	-	-
20	98	-	-	-	-	-	-	-
35	-	99	-	20	-	-	-	100
50	90	95	40	-	-	-	98	98*
60	-	-	-	-	-	99	-	-
80	-	-	-	-	-	97	-	-
100	60	65	20	-	-	-	90	90*
120	-	-	-	-	-	83	-	-
170	-	-	-	-	-	65	-	-
200	25	33	10	-	-	-	46	70
230	-	-	-	-	-	36	-	-
325	-	-	-	-	97*	22	-	50

*Minimum Percent

(9) The suggested uses of RDX based on class and granulation are as follows:

- (a) Class A, for use in Composition A3, Composition B, Composition C4, and cyclotol
- (b) Class B, for use in Composition A3 and Composition C4
- (c) Class C, for use in the preparation of RDX booster and detonator pellets
- (d) Class D, for use in cyclotols
- (e) Class E, for use in Composition C4 and plastic bonded explosives (PBX's)
- (f) Class F, for use in Composition B3
- (g) Class G, for use in PBX's
- (h) Class H, for use in Composition C4

c. Ethylenediamine Dinitrate (EDDN).

(1) This explosive is also designated EDD or EDAD. The compound (figure 8-21) is composed of white crystals with a specific gravity of 1.595 at 25/40, a nitrogen content of 30.10 percent, an oxygen balance to CO_2 of 25.8 percent, a melting point of 185° to 187°C, and a molecular weight of 186.13. The compound is soluble in water, but insoluble in alcohol or ether. EDDN has a heat of combustion of 374.7 kilocalories per mole at constant pressure, a heat of formation of 156.1 kilocalories per mole, and a heat of explosion of 127.9 to 159.3 kilocalories per mole. Eutectics are formed with ammonium nitrate, but EDDN is immiscible with molten TNT. An aqueous solution of EDDN is distinctly acidic. EDDN has been used to a limited extent as a bursting charge pressed in shells and as a cast charge in eutectic mixtures with ammonium nitrate. Mixtures with wax were used in boosters during World War II by the Germans.

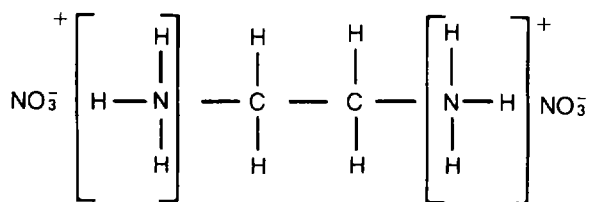

Figure 8-21. Structural formula for EDDN.

(2) EDDN is produced by neutralization of ethylenediamine dihydrate with concentrated nitric acid.

This is followed by the concentration and crystallization of the salt formed.

(3) EDDN is more sensitive to shock than TNT, having impact test values of nine inches and 75 centimeters, respectively, with the Picatinny and Bureau of Mines apparatuses. In rifle bullet impact tests with a charge of specific gravity 1.0 no detonations occurred on the impact of bullets with velocities below 960 meters per second and incomplete detonations occurred with bullet velocities around 1,000 meters per second. EDDN is less sensitive to initiation than TNT, requiring a minimum detonating charge of 0.10 gram of tetryl according to the sand test. Two grams of mercury fulminate are required for the initiation of a 50 gram sample pressed to a specific gravity of 1.23 in a paper cylinder 30 millimeters in diameter. In a gap test a minimum separation of 3.75 centimeters was found with paper cartridges each containing a 50 gram sample pressed to a density of 0.75. The explosion temperature test value of EDD is 445°C, as compared with 475°C for TNT. A small sample placed in a test tube ignites in six seconds when plunged into a bath preheated to 370°C, and in one second when the temperature of the bath is increased to 430°C. EDDN is ignited by open flame after one minute and continues to burn at the rate of 1.5 centimeters per minute.

(4) The sand test indicates EDDN is 96 percent as brisant as TNT, and plate dent test values are practically the same for the two explosives. The detonation velocity for a sample of EDDN with a specific gravity of 1.00 is 4,650 meters per second, 6,270 meters per second at a specific gravity of 1.33, and 6,915 meters per second at a specific gravity of 1.50. EDDN is indicated to be 114 percent and between 120 and 125 percent as powerful as TNT by the ballistic pendulum and Trauzl lead block tests, respectively.

(5) When heated in vacuum EDDN vaporizes and condenses without noticeable decomposition. When heated at 10 millimeters of pressure in an atmosphere of nitrogen or air, autocatalytic decomposition occurs between 230°C and 360°C. EDDN is hygroscopic to the extent of 1.24 percent at 90 percent relative humidity and 25°C. In the 120°C vacuum stability test, five milliliters of gas are evolved. Because of poor solubility, hygroscopicity, and acidity characteristics, EDDN is not very satisfactory for use as a military explosive and is an inferior substitute for TNT.

d. *Ethylenedinitramine (Haleite).*

(1) This compound is also known as N' N'-dinitroethylene diamine; ethylene dinitramine; or 1,2-dinitrodiaminoethane, and is sometimes designated EDNA. The name Haleite is in recognition of the development of this compound as a military explosive by the late Dr. G. C. Hale of Picatinny Arsenal. The compound (figure 8-22) is white with an orthorhombic crystal structure, a nitrogen content of 37.33 percent, an oxygen balance to CO₂ of 32 percent, an oxygen balance to CO of 10.5 percent, and a molecular weight of 150.10. The density of the crystals vary from 1.66 to 1.77 depending on the solvent from which the crystallization took place. Packing density as a function of pressure is shown in table 8-22.

Table 8-22. Haleite Packing Density

Pressure grams per cubic kilopascals	Pressure pounds square inch	Density grams per cubic centimeter
34,475	5,000	1.28
68,950	10,000	1.38
82,740	12,000	1.41
103,425	15,000	1.44
137,900	20,000	1.49

Haleite melts with decomposition at 177.30C, but does not extrude. The solubility of Haleite in water at 10°, 20°, 50°, 75°, and 95°C is 0.10, 0.25, 1.25, 5.0, and 16.4 grams, respectively, per 100 grams of solvent. In 95 percent ethanol at 10°, 20°, 50°, 75°, and 78.5°C, Haleite is soluble to the extent of 0.55, 1.00, 3.50, 10.07, and 11.5 grams, respectively, per 100 grams of solvent and is soluble in methanol. Haleite is insoluble in ether, but in acetone at 200C, Haleite is soluble to the extent of 8.2 grams per 100 grams. Haleite is soluble in nitromethane, nitrobenzene, and dioxane, which can be used to recrystallize the explosive. The heat of combustion of Haleite at constant pressure is 2,477 calories per gram, from which a heat of formation value of 20.11 kilogram-calories per mole is derived. The heat of explosion is 1,276 calories per gram.

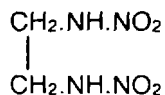
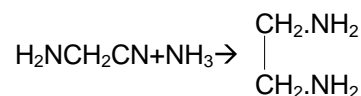
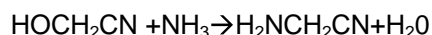
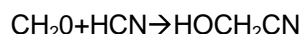

Figure 8-22. Structural formula for Haleite.

(2) Haleite is an explosive that combines the properties of a high explosive like TNT and an initiating

agent like mercury fulminate or lead azide, possessing a high brisance and comparatively low sensitivity. No other high explosive is known which has such a low sensitivity to impact and at the same time so readily explodes by heat. Another important characteristic of Haleite is a relatively low explosion temperature, approaching that of mercury fulminate or nitroglycerin. Haleite lacks oxygen for complete combustion to CO₂. Mixtures with oxidizing agents such as ammonium nitrate, potassium chlorate, and ammonium perchlorate yield a series of explosive mixtures more powerful than Haleite.

(3) The first step in the manufacture of Haleite is the production of ethylene diamine. One reaction employed is:



The yield of the second reaction is 82 percent. The third reaction is carried out under high pressure. The ethylene diamine is converted to ethyleneurea, 2-imidazolidinone, by either reacting with diethylcarbonate or carbon dioxide. The reaction with diethylenecarbonate is not generally used because the yield is only 42 percent of theoretical and the reaction requires the use of high pressure and high temperature for an extended period of time. The reaction with carbon dioxide is carried out under 820 atmospheres of pressure at 220°C. The reactions are shown in figure 8-23. The ethyleneurea can be nitrated with either concentrated nitric acid or a mixture of nitric and sulfuric acids. In the latter case, 10 parts of mixed acid containing 74.0 percent sulfuric acid, 15.4 percent nitric acid, and 10.6 percent water are cooled to 10°C or less and agitated. One part of ethyleneurea is added at such a rate that the temperature does not rise above 10°C. After the last portion of the ethyleneurea has been added, stirring is continued for five minutes. A variation of this process is to dissolve 1 part of ethyleneurea in 7.5 parts of 95 percent sulfuric acid, while maintaining the temperature at 20°C. This solution then is added slowly, while maintaining the temperature of the mixture at 0°C or less, to 3.33 parts of a mixed acid containing 15.8 percent sulfuric acid, 66.7 percent nitric acid, and 17.5 percent water. When addition is complete, the temperature is increased to 10°C and maintained at that value for two hours. The dinitroethyleneurea is caught on a filter and

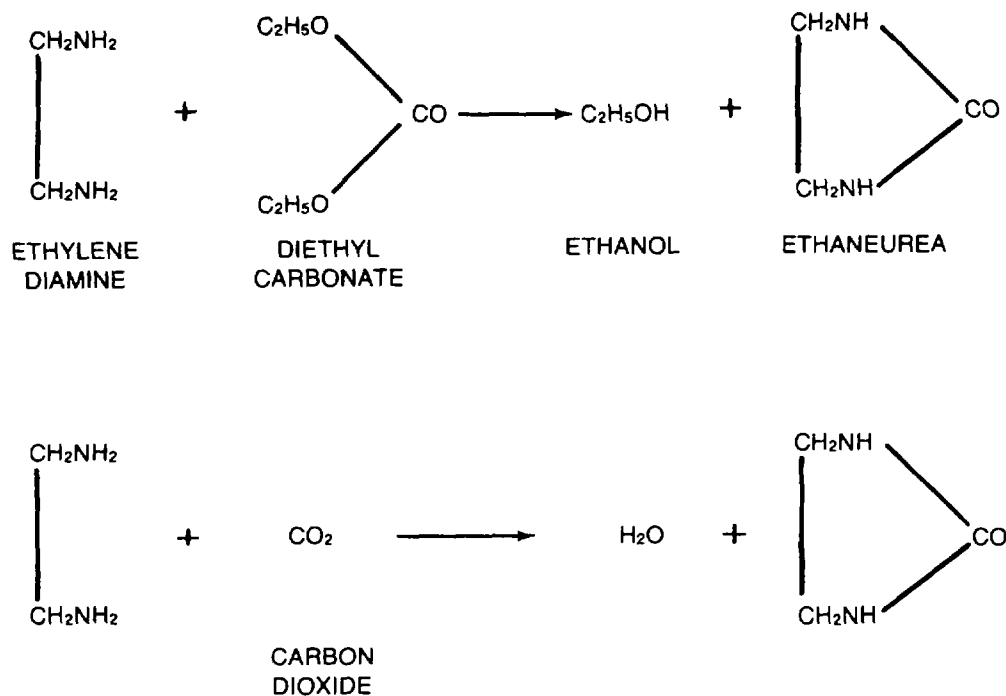

Figure 8-23. Production of ethyleneurea.

washed with ice water until the washings are almost neutral. Additional dinitroethyleneurea is recovered by drowning the spent acid in ice water. A total yield of 97 percent of the theoretical is obtainable. One part dinitroethyleneurea, by weight, is suspended in seven parts water and boiled until the evolution of carbon dioxide ceases. The reaction is shown in figure 8-24. Haleite separates as shining crystals when the solution is cooled to room temperature. This is caught on a filter, washed with cold water, and dried. The total yield of Haleite from ethyleneurea is approximately 92 percent of the theoretical. Another method of producing Haleite is by treating dinitroethylenediurethane with an alcoholic solution of ammonia followed by acidifying with hydrochloric acid. This reaction is shown in figure 8-25.

(4) One grade of Haleite is specified for military purposes. This complies with the following requirements:

Color: White to buff.
 Moisture: Maximum, 0.10 percent.
 Melting point: Minimum, 174.0°C.
 Purity: Minimum, 99.0 percent.
 Water insoluble matter: Maximum, 0.10 percent.

Grit: None.

120°C vacuum stability test: Maximum, 5.0 milliliters of gas in 40 hours.

Granulation:

	Percent
Through US No. 10 sieve, minimum	100
Through US No. 100 sieve, maximum	20

(5) Impact tests show Haleite to be slightly more than twice as sensitive as TNT, with a 48 centimeter drop height versus 100 centimeters for TNT. In the rifle bullet impact test for 100 trials, there were 60 partial detonations, 20 burnings, and 20 unaffected. Haleite is unaffected by either the fiber or steel shoe in the pendulum friction test. A minimum initiating charge of 0.21 grams of mercury fulminate or 0.13 grams of lead azide are required for initiation. In the gap test, a minimum separation of 14 centimeters was found for two paper cartridges, each containing 50 grams of Haleite at a density of 0.80. This value is 64 percent of that for tetryl at a density of 0.94. The explosion temperature test value is 190°C. The 0.1 second explosion temperature test value is 265°C. Haleite flammability index is 138 seconds.

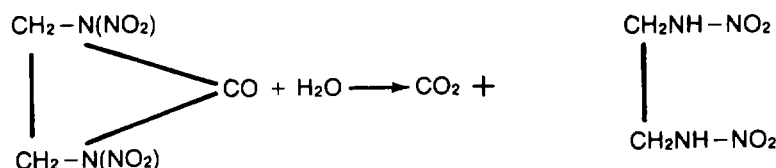

Figure 8-24. Boiling of dinitroethyleneurea.

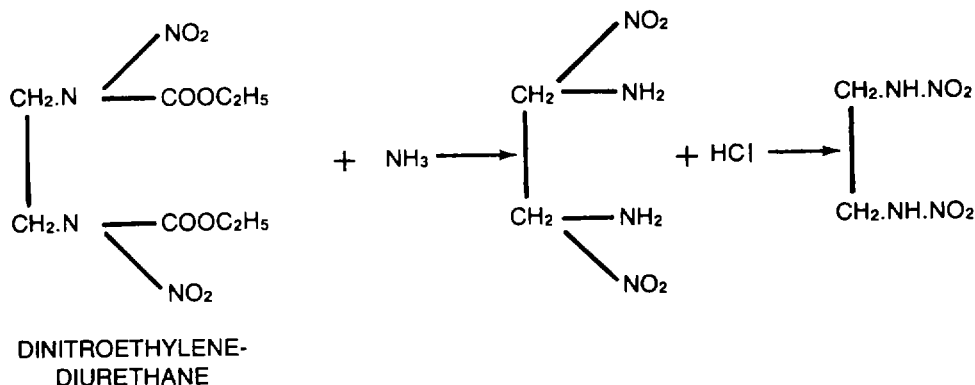

Figure 8-25. Production of Haleite.

(6) As measured by the sand test, Haleite has a brisance of 109 to 119 percent of that for TNT. The plate dent test indicates a brisance value of 113 to 122 percent of TNT. The plate cutting test indicates a brisance equal to that of PETN. A fragmentation test using a three inch, high explosive, M42A shell with a charge of 95 percent Haleite and 5 percent wax at a density of 1.56 was found to produce 117 percent as many fragments as TNT. Other fragmentation test values varied from 136 to 147 percent of TNT. The detonation velocity for a sample at a density of 1.55 grams per cubic centimeter is reported as 7,883 meters per second. For a sample of density 1.50, a detonation velocity of 7,580 meters per second was reported and a velocity of 5,650 meters per second for a sample of density 1.0. The ballistic mortar tests indicate Haleite is 136 to 140 percent as powerful as TNT. The Trauzl test indicates a power of 122 to 143 percent of TNT.

(7) In the 100°C heat test, a 0.2 percent weight loss was reported in the first 48 hours, and 0.3 percent was lost in the second 48 hours. No explosions occurred. The 135°C heat test results are satisfactory. The 75°C international heat test result is that a 0.01 percent loss occurs in 48 hours. Decomposition

temperatures are 170°C in 20 seconds, 173°C in 15 seconds, 178°C in 10 seconds, 189°C in 5 seconds. At higher temperatures, Haleite darkens to a red brown with the evolution of NO₂. Haleite is hygroscopic to the extent of 0.01 percent at 90 percent relative humidity. In the vacuum stability test at 100°C with a five gram sample, 0.5 cubic centimeters of gas are evolved in 48 hours. At 120°C, 1.5 to 2.4 cubic centimeters of gas are evolved, and at 135°C more than 11 cubic centimeters are evolved. Tests have shown Haleite to be volatilized at the rate of 0.05 percent per hour when heated at 100°C in an open dish. Storage tests have shown dry Haleite to be of unimpaired stability after storage at 65°C for five months or 50°C for 30 months. Therefore, Haleite is considered to be of satisfactory stability at the normal exposure temperatures for storage and handling. Dry Haleite does not cause corrosion of aluminum, brass, copper, mild steel, stainless steel, cadmium, nickel, or zinc. Magnesium and magnesium alloys are slightly affected by dry Haleite. Stainless steel is not corroded by wet Haleite, but copper, brass, mild steel, cadmium, nickel, and zinc are heavily corroded in the presence of as little as 0.5 percent moisture.

e. Nitroguanidine (NQ).

Table 8-23. Solubility of Nitroguanidine in Sulfuric Acid

Sulfuric acid percentage in water	Temperature °C	Grams dissolved per 100 cubic centimeters
0	0	0.12
	25	0.42
15	0	0.3
	25	0.55
20	0	0.45
	25	1.05
25	0	0.75
	25	1.8
30	0	1.3
	25	2.9
35	0	2.0
	25	5.2
40	0	3.4
	25	8.0
45	0	5.8
	25	10.9

(1) This explosive is also known as picrite or guanylnitramine. The compound (figure 8-26) has a nitrogen content of 53.84 percent, an oxygen balance to CO₂ of -30.8 percent, a theoretical maximum density of 1.81 grams per cubic centimeter, a nominal density of 1.55 to 1.75 grams per cubic centimeter, and a molecular weight of 104.1. The melting point of nitroguanidine varies somewhat with the rate of heating. The pure material melts with decomposition at 232°C, but values from 220°C to 250°C are obtainable with various heating rates. At least two crystalline forms exist for nitroguanidine; alpha and beta. The alpha form is obtained when nitroguanidine is dissolved in concentrated sulfuric acid and then drowned with water. The crystals formed are long, thin, lustrous, flat needles that are tough and very difficult to pulverize. The needles have a double refraction value of 0.250. This is the form most commonly used in the explosive industry. The beta form crystallizes from hot water in fern-like clusters of small, thin, elongated plates. The plates have a double refraction value of 0.185. The beta form may be converted into the alpha by dissolving in concentrated sulfuric acid and drowning in water. Neither form, however, is converted into the other by recrystallization from water, and the two forms can be separated by fractional crystallization from water. The beta form may also be converted to the alpha form by decomposition of the nitrate or hydrochloride formed by beta nitroguanidine. When alpha nitroguanidine is decomposed by heat, some beta nitroguanidine is formed; but the beta compound generally is obtained by the nitration of the mixture of guanidine sulfate and ammonium sulfate, resulting from the hydrolysis of dicyandiamide, H₂N.C(:NH).NH.CN, by sulfuric acid. The alpha form is obtained by the reaction of guanidine and nitric acid to form the nitrate. The nitrate is dehydrated to form the nitrocompound. Both forms of nitroguanidine have the same melting point and are alike in most chemical and physical properties. The unit cell dimensions are 17.58 Angstroms, 24.84 Angstroms, and 3.58 Angstroms. There are 16 molecules per cell. The refractive index is; alpha equals 1.526, beta equals 1.694, and gamma equals 1.81. However, they differ slightly in solubility in water except at 25°C and 100°C, where their solubility curves cross, having values of 0.42 to 0.44 grams per 100 milliliters at 25°C and 8.25 grams per 100 milliliters at 100°C. Solubility between 25°C and 100°C is slightly lower for the alpha than for the beta form. At 0°C the solubility for both forms is about 0.12. Both forms are slightly soluble in alcohol and nearly insoluble in ether. In a solution of one normal potassium hydroxide at 250°C the solubility is 1.2. Table 8-23 lists the solubility for nitroguanidine in sulfuric acid at various concentrations and temperatures.

Nitroguanidine has a crystal density of 1.715, but because of the toughness and flexibility of the crystals, a density of only 0.95 is obtained when subjected to a pressure of 3,000 psi. The heat of combustion of nitroguanidine at constant pressure is 210.4 kilocalories per mole, and from this is derived a heat of formation value of 20.29 kilogram-calories per mole. The heat of detonation is 1.06 kilocalories per gram with liquid water and 880 calories per gram with gaseous water. The volume of gas produced is 1077 cubic centimeters per gram.

Nitroguanidine is essentially nonvolatile. The vapor pressure is given by the equation:

$$\log p_a = 13.01 - 7014/T(^{\circ}\text{C})$$

$$\text{for } 70.70^{\circ}\text{C} < T < 174.20^{\circ}\text{C}$$

One torr equals 133 pa. The specific heat, in calories per gram per degree centigrade, for high bulk density nitroguanidine is:

$$0.269 + (7.0 \times 10^{-4})T \text{ for } 37^{\circ}\text{C} < T < 167^{\circ}\text{C}$$

The specific heat for low bulk density nitroguanidine is:

$$0.242 + (11.1 \times 10^{-4})T \text{ for } 370^{\circ}\text{C} < T < 167^{\circ}\text{C}$$

Because of the low temperature of explosion, about 2,098°C, nitroguanidine is used in triple-base propellants that are practically flashless and less erosive than nitrocellulose-nitroglycerin propellant of comparable force. When used by the Germans in World War II in antiaircraft guns, a nitroguanidine propellant increased the barrel life from 1,700 firings to about 15,000 firings.

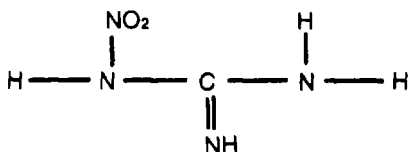
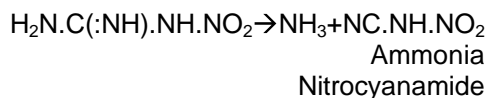
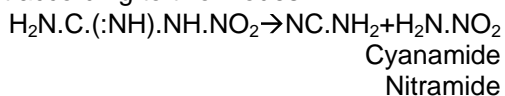

Figure 8-26. Structural formula for nitroguanidine.

(2) Nitroguanidine is chemically reactive because of a free amino group as well as a nitro group and a tendency toward dearrangement. With hot concentrated nitric acid, nitroguanidine forms a nitrate that melts at 147°C and, with strong hydrochloric acid, yields a crystalline hydrochloride. On reduction, nitroguanidine yields nitrosoguanidine, $H_2N.C(NH).NH.NO$, and then aminoguanidine, $H_2N.C(:HN).NH.NH_2$. With a solution of diphenylamine in sulfuric acid, nitroguanidine gives a blue color. When tested with ferrous ammonium sulfate and sodium hydroxide, a fuchsine color is developed. When warmed with water and a large excess of ammonium carbonate, nitroguanidine forms guanidine carbonate. With an aqueous solution of hydrazine, nitroguanidine reacts to form N-amino, N'-nitroguanidine, $N_2N.HN.C(:NH).NH.NO_2$, which melts at 182°C. On being heated or undergoing reaction in sulfuric acid solution, nitroguanidine appears to undergo dearrangement according to two modes:



When decomposed by heating above the melting point, the products obtained from nitroguanidine are water, nitrous oxide, cyanamide, melamine, ammonia, cyanic acid, cyanuric acid, ammeline, and ammelide. These are the products to be anticipated from the dearranged compound. The reaction and decomposition of the primary products of decomposition form carbon dioxide, urea, melam, melem, mellon, nitrogen, hydrocyanic acid, cyanogen, and paracyanogen. In aqueous solution, nitroguanidine dearranges in both of the above

modes, but this is only to a small degree, unless another compound is present to react with one of the products of dearrangement. As a result of this, nitroguanidine is relatively stable in aqueous solution. A saturated aqueous solution at 25°C has a pH value of 5.5. After being heated at 60°C for two days, such a solution has a pH value of 8.5. In the absence of ammonia and in the presence of a primary aliphatic amine, nitroguanidine reacts to form an alkylnitroguanidine as if the amine reacted with nitrocyanamide present by dearrangement. A solution of either form of nitroguanidine in concentrated sulfuric acid acts chemically as if the nitroguanidine had dearranged into nitramide and cyanamide, although alpha nitroguanidine is precipitated if the solution is poured into water. When such a solution is warmed, nitrous oxide and a little nitrogen are evolved at first from the dehydration of nitramide. Later and more slowly, carbon dioxide is liberated resulting from the hydrolysis of cyanamide. After standing for some time, a sulfuric acid solution of nitroguanidine no longer gives a precipitate of nitroguanidine when diluted with water. Although a freshly prepared solution contains no nitric acid, this is formed by the hydration of nitramide, if a material that can react with nitric acid is present. Consequently, nitroguanidine splits off the nitro group quantitatively and the purity of the material can be determined by the nitrometer method.

(3) The specification for military nitroguanidine covers two types of material and two classes with respect to granulation. The requirements with which the explosive must comply are as follows:

Properties	Type I, %		Type II, %	
	Min	Max	Min	Max
Purity (assay)	98.0	-	99.0	-
Ash content	-	0.30	-	0.30
pH value	4.5	7.0	4.5	7.0
Acidity (as sulfuric acid)	-	0.60	-	0.06
Total volatiles	-	0.25	-	0.25
Sulfates (as sodium sulfate)	-	0.20	-	0.20
Water insoluble impurities	-	0.20	-	0.20

Granulation requirements are as follows:

Type	Class	Minimum in microns	Maximum in microns
I	1	4.3	6.0
	2	-	3.3
II	1	3.4	6.0
	2	-	3.3

(4) Several methods for the preparation of nitroguanidine are known. The earliest method was by the direct nitration of guanidine thiocyanate with mixed acids. Guanidine thiocyanate is one of the cheapest and easiest to prepare of the guanidine salts. However, this method of production also produced sulfur compound impurities which attacked nitrocellulose. This lowered the stability of propellant compositions to an unacceptable degree, thus precluding early use of the compound as an ingredient in nitrocellulose based propellants. A more pure form of nitroguanidine that does not contain the sulfur compound impurities can be prepared in one of several known ways. In one method equimolecular quantities of urea and ammonium nitrate are fused according to the equation:

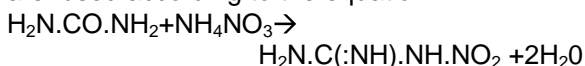

The product is then recrystallized from boiling water. The yield of this method is approximately 92 percent of the theoretical. Another method of preparation involves heating a solution of equimolecular quantities of cyanamide and ammonium nitrate to 160°C at a pressure of 200 pounds. The reaction proceeds according to the equation:

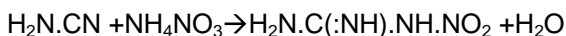

The product is then recrystallized from boiling water. The yield of this method is approximately 88 percent. A third method involves the production of guanidine nitrate as a precursor to the nitroguanidine. Two reactions can be employed to produce guanidine nitrate. The first reaction:

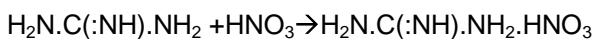

is simply the reaction between guanidine and nitric acid. The second reaction:

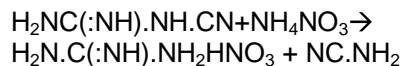

is the reaction between dicyandiamide and ammonium nitrate. As the guanidine or dicyandiamide can be produced from the raw materials coke, limestone, atmospheric nitrogen, and water, the production of nitroguanidine does not involve the use of special natural resources. However, a very large amount of electrical energy is required for the production of dicyandiamide or guanidine. Dehydration of guanidine nitrate to nitroguanidine is affected by adding 1 part of the nitrate to 2.3 parts by weight of sulfuric acid (95 percent), so that the temperature does not rise above 10°C. The reaction proceeds according to the equation:

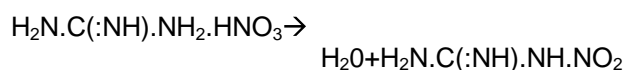

As soon as all the nitrate has been dissolved, the milky solution is poured into seven and one-half parts of ice and water. The mixture is kept ice-cold until precipitation is complete, when the nitroguanidine is caught on a filter, washed with cold water, and redissolved in 10 parts of boiling water. The nitroguanidine recrystallizes when the solution cools. The yield is approximately 90 percent of the theoretical.

(5) Impact sensitivity test results are 47 centimeters using the standard two kilogram weight in the Bureau of Mines apparatus and 26 inches using a nonstandard weight of one pound in the Picatinny Arsenal apparatus. Even when a factor is applied to correct for the nonstandard weight, the values obtained are inconsistent. The preponderance of evidence, however, is that this explosive is considerably less sensitive than TNT to impact as well as friction and initiation. Gap test results for nitroguanidine are shown in table 8-24. Nitroguanidine is unaffected by the rifle bullet impact test and both the fiber and steel shoes in the pendulum friction test. The result of the five second explosion temperature test is 275°C. A minimum charge of 0.20 grams of lead azide or 0.10 grams of tetryl are required for initiation. Sensitivity to initiation varies somewhat with crystal size. Larger quantities can be detonated by a blasting cap containing 1.5 grams of mercury fulminate. Nitroguanidine, therefore, may be classified as one of the least sensitive of military explosives.

Table 8-24. Gap Test Results for Nitroguanidine

	Density grams per cubic centimeter	Percent voids	Sensitivity in millimeters
LANL small scale gap test	1.575 (pressed)	11.8	no explosions
LANL large scale gap test	1.715 (pressed)	3.5	no explosions
	1.609 (pressed)	9.6	5.00

(6) The sand test indicates nitroguanidine to be between 73.5 and 84 percent of TNT. At a density of 1.5 grams per cubic centimeter, the plate dent test indicates a brisance of 95 percent of TNT, and the lead block compression test indicates 73 percent of TNT. The critical diameter at a density of 1.52 grams per cubic centimeter is between 1.27 millimeters and 1.43 millimeters. At a density of 1.70 grams per cubic centimeter the detonation velocity is 8.100 meters per second. At a specific gravity of 1.5 the velocity is 7,650 and at a specific gravity of 1.0 the velocity is 5,360. At a density of 1.55 grams per cubic centimeter, nitroguanidine has a higher velocity of detonation than TNT at the same density; 7,650 compared to 6,900 for TNT. The detonation velocity as a function of density is given by the equation:

$$d = 1.44 + 4.015p$$

where d is in kilometers per second and p, the density, is in grams per cubic centimeter. By the Trauzl test, nitroguanidine is 78 to 101 percent as powerful as TNT, and by the ballistic mortar test, 104 percent as powerful. The temperature of explosion is about 2098°C as compared to 2820°C for TNT. The relatively small heat of explosion explains nitroguanidine's cooling effect when present in propellant compositions.

(7) Nitroguanidine begins to undergo decomposition at a higher temperature, 232°C, than does TNT, 80°C to 200°C. The results of the 75°C international test is a 0.04 percent weight loss in 48 hours. The 100°C heat test results are 0.48 percent weight loss in the first 48 hours, 0.09 percent in the second 48 hours and no explosions in 100 hours. Vacuum stability tests at 120°C show nitroguanidine and TNT to be of the same order of stability. As both are essentially nonhygroscopic and very slightly soluble in water, the impairment of stability by moisture is not a practical problem. In the LLNL reactivity test, 0.02 to 0.05 cubic centimeters of gas are evolved per 0.25 grams of sample. Propellant compositions containing nitroguanidine have been found to be of a high order of stability; indications are that the nitroguanidine acts to some extent as a stabilizer, since such compositions generally do not liberate red fumes when subjected to the 65.5°C surveillance test. The DTA curve for nitroguanidine is shown in figure 8-27. The TGA curve is shown in figure 8-28.

f. 2, 4,6Trinitrophenylmethylnitramine (Tetryl).

(1) This explosive is also known as: 2,4,6tetranitro-N-methyl aniline; N-methyl-N,2,4,6tetranitro-benzenamine; 2,4,6-trinitrophenylmethylnitramine; tetranitromethylamulene; or picrylmethylnitramine and is sometimes referred to as pyronite, tetrylit, tetralite, tetralita, or CE. The compound (figure 8-29) is colorless when freshly prepared and highly purified, but rapidly acquires a yellow color when exposed to light. Tetryl has a nitrogen content of 24.4 percent, an oxygen balance to CO₂ of -47 percent, a nominal density of 1.71 grams per cubic centimeter with a theoretical maximum density of 1.73 grams per cubic centimeter, and a molecular weight of 287.15. The melting point of the pure substance is 129.45°C and of the technical grade, 129°C. Melting is accompanied by partial decomposition. Repeated solidification and melting rapidly increase the degree of decomposition. Tetryl has a scratch hardness of less than one on the Mohs' scale and therefore the crystals are slightly softer than talc. The crystals are monoclinic with unit cell dimensions of a = 14.13 Angstroms, b = 7.37 Angstroms, c = 10.61 Angstroms. There are four molecules per unit cell. The refractive index is: alpha, 1.546; beta, 1.632; gamma, 1.74. Table 8-25 lists the density of tetryl as a function of loading pressure.

Table 8-25. Density as a Function of Loading Pressure for Tetryl

Loading pressure in kilopascals	Loading pressure in pounds per square inch	Density in grams per cubic centimeter
20,685	3,000	1.40
34,475	5,000	1.47
68,950	10,000	1.57
82,740	12,000	1.60
103,425	15,000	1.63
137,900	20,000	1.67
206,850	30,000	1.71
	cast	1.62

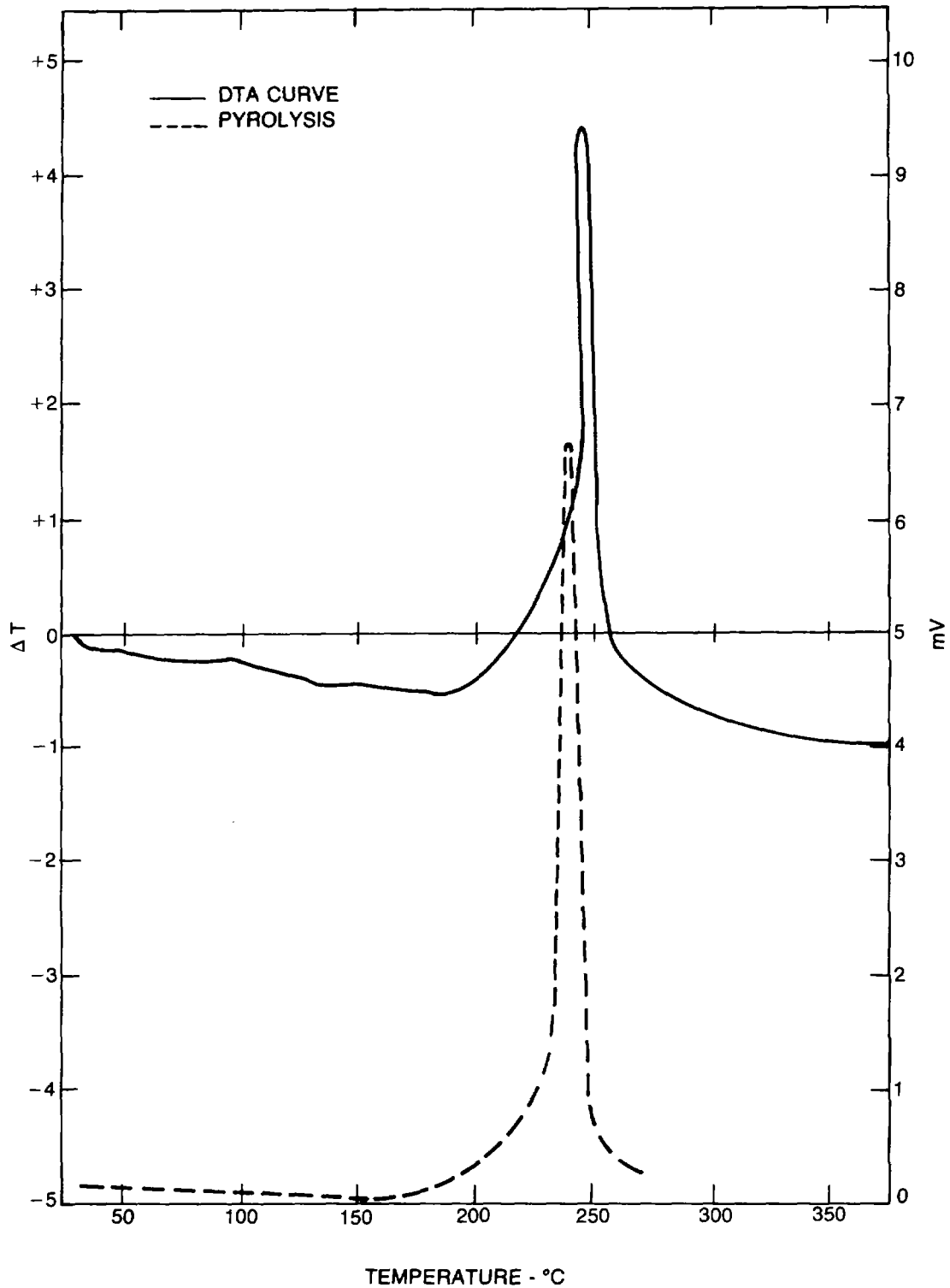

Figure 8-27. DTA curve for nitroguanidine.

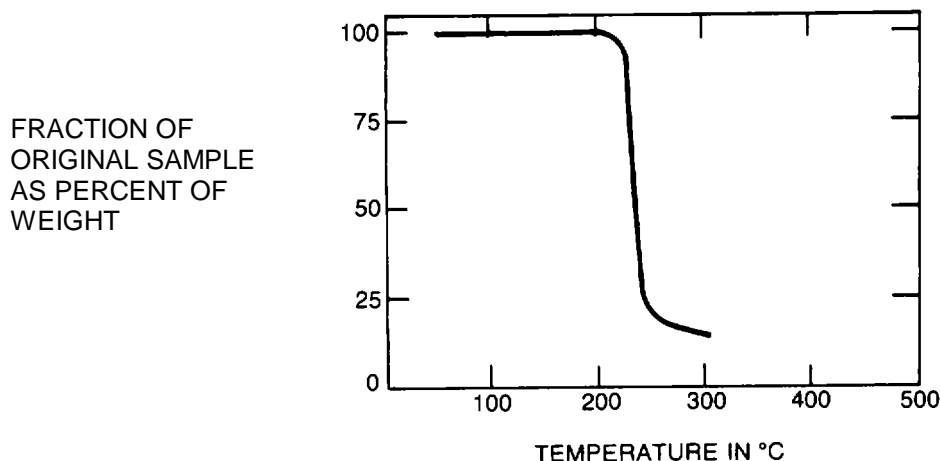

Figure 8-28. TGA curve for nitroguanidine.

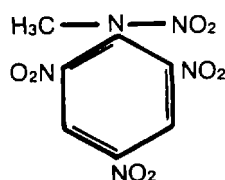

Figure 8-29. Structural formula for tetryl.

Over the temperature range of 200° to 403° Kelvin, the specific heat of tetryl as a function of temperature has been found to be

$$\text{Specific heat} = 0.213 + (2.18 \times 10^{-4})T - (3.73 \times 10^{-7})T^2$$

where T is in degrees Kelvin and the specific heat is in units of calories per gram per degree centigrade. Table 8-26 lists the dielectric constant for tetryl at various densities.

Table 8-26. Dielectric Constant of Tetryl

Density grams per cubic centimeter	Dielectric constant measured at 35 giga cycles
0.9	2.059
1.0	2.163
1.4	2.782
1.5	2.905
1.6	3.097
1.7	3.304

Tetryl has a heat of fusion of 5.9 kilocalories per mole and entropy of fusion of 13.7 eu. The heat of vaporization value is 26 kilocalories per mole, the coefficient of thermal expansion is 0.32×10^{-3} per degree, and the thermal conductivity in cgs units is 6.83×10^{-4} at a density of 1.53 grams per cubic centimeter. Tetryl's heat of combustion at constant pressure is 2,914 calories per gram. The heat of formation value is 4.67 to 7.6 kilogram-calories per mole. The vapor pressure in torr of tetryl is given by the equation:

$$\log p = 13.71 - 6776/T(K) \quad \text{for } 85^\circ\text{C} < T < 106^\circ\text{C}$$

Tetryl dissolves readily in concentrated nitric acid and moderately well in other mineral acids but is soluble to the extent of only 0.3 percent in the spent acid after manufacture. Table 8-27 lists tetryl solubility in various solvents at the temperatures given. Benzene holds more tetryl in solution if a solution with solid tetryl present is cooled to a given temperature than if a mixture of benzene and an excess of tetryl is heated to and maintained at a given temperature. At 15°C, 25°C, 35°C, 45°C, and 55°C, tetryl has respective supersolubility values of 10.2, 12.2, 14.9, 18.25, and 22.5 and subsolubility values of only 3.9, 5.5, 7.4, 9.7, and 13.25 grams per 100 grams of benzene.

Table 8-27. Solubility of Tetryl in Various Solvents

Solvent	Grams per 100 grams of solvent											
	0°C	10°C	20°C	30°C	40°C	50°C	60°C	70°C	80°C	90°C	100°C	120°C
Water	0.0050	-	0.0075	-	0.0110	-	-	-	0.810	-	0.184	-
Carbon tetrachloride	0.007	-	0.015	-	0.058	-	0.154	-	-	-	-	-
Ether	0.188	0.330	0.418	0.493	-	-	-	-	-	-	-	-
95% Ethanol	0.320	0.425	0.563	0.76	-	1.72	-	5.33 at 75°C	-	-	-	-
Chloroform	0.28	-	0.39	-	1.20	-	2.65	-	-	-	-	-
Carbon disulfide	0.009	0.015	0.021	0.030	-	-	-	-	-	-	-	-
Ethylene dichloride	-	4.5 at 25°C	-	-	-	-	-	45 at 75°C	-	-	-	-
Acetone	-	-	75	95	116	138	-	-	-	-	-	-
Trichloroethylene	0.007	-	0.12	-	0.26	-	-	-	1.50	1.76 at 86°C	-	-
Ethyl acetate	-	-	40 approx.	-	-	-	-	-	-	-	-	-
Toluene	-	-	8.5	-	-	-	-	-	-	-	-	-
Xylene	-	-	3.3	4.4	5.4	6.0	-	-	-	-	-	-
TNT	-	-	-	-	-	-	-	-	82	-	149	645

(2) Tetryl is highly resistant to attack by dilute mineral acids, but does react with concentrated acid or weak basic solutions. Trinitrophenyl methylamine (figure 8-30) is formed when tetryl reacts with concentrated sulfuric acid or with phenol. Prolonged boiling with dilute sulfuric acid has no effect. When tetryl is boiled with a solution of sodium carbonate, dilute aqueous sodium hydroxide, or dilute aqueous potassium hydroxide, the nitramino group is hydrolyzed as shown in figure 8-31. If this reaction is carried out in a nitrometer in the presence of mercury, the nitric acid is reduced to nitric oxide and can be measured. In benzene solution at ordinary temperatures, tetryl reacts with aniline to form 2,4,6-trinitrodiphenylamine and methyl nitramine as shown in figure 8-32. Aqueous sodium sulfide decomposes tetryl completely into nonexplosive, water soluble products. The reaction is relatively slow unless the solution is heated to 80° to 90°C. Prolonged heating of tetryl at 120°C yields picric acid. Tetryl is reduced and hydrolyzed to 2,4,6-triaminophenol by the action of tin and hydrochloric acid. Tetryl and TNT form an addition compound with a mole ratio of one to two, respectively. An addition compound is also formed with naphthalene with a mole ratio of one to one. Tetryl forms a eutectic mixture with 76.5 percent trinitro-m-xylene that has a melting point of 118.8°C, and with 29.5 percent trinitroanisole that has a melting point of 22.8°C.

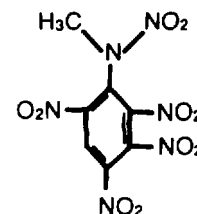

Figure 8-30. Trinitrophenyl methylamine.

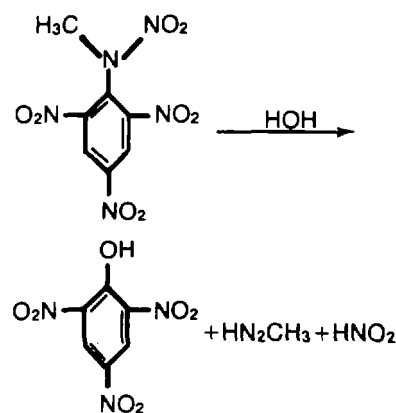

Figure 8-31. Hydrolysis of tetryl.

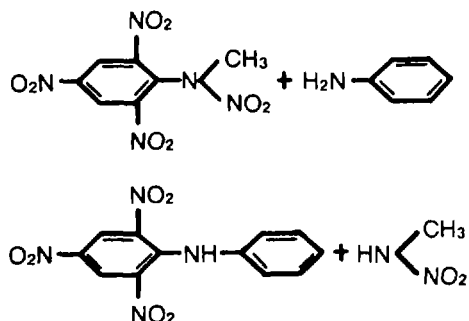

Figure 8-32. Reaction of tetryl with aniline.

(3) A number of homologs and analogs of tetryl are known. Figure 8-33 shows some examples.

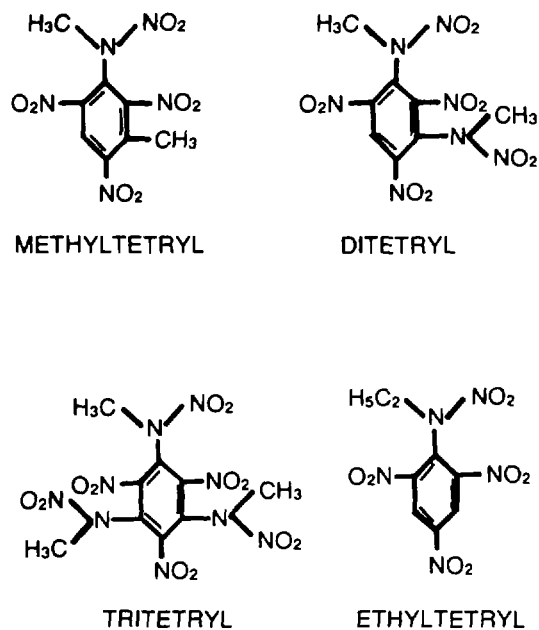

Figure 8-33. Homologs and analogs of tetryl.

(4) Tetryl is fairly resistant to degradation by gamma radiation. Exposure to a 10^4 Curie C_{60} source,

which emits gamma rays at 1.173 and 1.332 million electron volts, produced some erratic results, but on the whole the changes induced by this exposure were not great. A sample exposed to 1.4×10^7 R passed the 120°C vacuum stability test, but a sample exposed to 1.2×10^8 R could only pass the 100°C test and failed in the 1200°C test. Weight loss increased dramatically when exposure levels were increased from 1.3×10^8 R to 10^9 R. Irradiated samples did not show much change over control samples in the DTA test until exposure levels reached 1.2×10^8 R, and even at 10^9 R changes were moderate. The impact sensitivity, detonation velocity, and explosion temperature are only slightly affected by exposure to gamma radiation.

(5) Tetryl shows negligible reaction with: Adhesive EC 1099, Dapon resin, Delrin, Epoxy 907 adhesive, Galvanoplast, conductive paint, Glastimat No. 1, Lexan, Loctite 404, Molyube No. 18, Permacel PN 112 tape, Polyesters, polysulfide rubber sealant, polyurethane EP 626/628, RTV 102 and 732 vulcanizing rubbers, Silastic RTV 731 or 732 (uncured), Silicone No SE 1201 and No Q 95-011, urea-formaldehyde. Tetryl is also compatible with the following adhesives: Adiprene L-10Q, L-167 and LD-213, and Eastman 910.

(6) As of 1979 the United States has discontinued the use of tetryl. No new components are being designed with tetryl, and all components that contained tetryl are being redesigned to eliminate the tetryl. The reason for this action is the relative instability of tetryl after storage at elevated temperatures. Various NATO nations have not discontinued tetryl's use in boosters and lead charges.

(7) Two methods have been used extensively for the manufacture of tetryl. The first method uses methylamine (CH_3NH_2), a cheap commercial bulk chemical, in the production of dinitrophenylmethylamine from 2,4- or 2,6-dinitrochlorobenzene by the reaction:



This can be nitrated to tetryl with relative ease. A considerable amount of tetryl was prepared by this method in the United States during World War II. A variation on this method is used at the present time in Germany. The reaction between the 2,4or 2,6-dinitrochlorobenzene and methylamine is carried out in the presence of sodium hydroxide. The dinitrophenylmethylamine is then dissolved in sulfuric acid, which is made up from spent acid and contains some nitric acid, oxides of nitrogen and 16 percent water. This solution is then added to mixed acid containing 78 percent nitric acid, 6 percent sulfuric acid, and 16 percent water. The second method uses dimethylaniline as the starting material. The use of dimethylaniline has the disadvantage of requiring nitric acid for the removal of one methyl group by oxidation according to the equation:

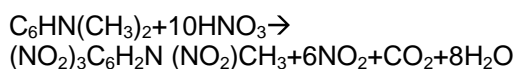

This disadvantage is not shared by the first process described above. Direct nitration of dimethylaniline proceeds so violently that the reaction can be carried out only under specialized conditions. The dimethylaniline is converted to dimethylaniline sulfate by dissolving one part of the chemical in 14.4 parts of 96 to 99 percent sulfuric acid at 20°C to 30°C. Many years experience in tetryl manufacture has shown that the ratio of sulfuric acid to dimethylaniline should not be lower than 3: 1, since a smaller amount of sulfuric acid may be detrimental to the nitration process. However, the ratio of sulfuric acid to dimethylaniline must not be too high, otherwise tetryl yield is decreased. Sulfonation of the benzene ring will occur if the temperature is not maintained between 20°C and 40°C. A quantity of 15.4 parts of the solution of dimethylaniline sulfate is added in a nitrator to 9.2 parts of mixed acid which contains 66.7 percent nitric acid, 15.8 percent sulfuric acid, and 17.5 percent water. The contents of the nitrator are heated to 68°C then heating is discontinued. This step involves a reaction that oxidizes a methyl group and is highly exothermic. The temperature of the reaction must be maintained at 60°C to 72°C by external means, if necessary. For safe and efficient nitration, very vigorous stirring is essential to ensure that the reacting liquids are mixed almost instantaneously. The mixture is kept in this nitrator for a very short period, so the reaction may be incomplete. The contents of the nitrator are discharged via an overfall to a larger reactor that is also equipped with a stirrer. In this reactor, which is maintained at 70°C, the reaction is completed. Commercial dimethylaniline contains some

methylaniline which is nitrated to 2,3,4,6-tetranitrophenylmethylamine (also called m-nitroethyl) which in turn is readily hydrolyzed to 2,4,6-trinitro-3-hydroxyphenylmethylamine. The nitration and hydrolysis are shown in figure 8-34. The compound formed is readily soluble in water and easily removed. If the water content of the mixed acid is too high, benzene insoluble impurities are formed which are benzidine derivatives. The derivatives are shown in figure 8-35. After the reaction is completed in the reactor, the liquid which contains partially crystallized tetryl is allowed to run into a crystallizer which is maintained at 20°C. The crystallized product is discharged to a vacuum filter where the tetryl is collected and the spent acid is passed on to be renitrated. Tetryl must then be purified carefully to remove any tetranitrocompound and occluded acidity, which have adverse effects on the stability of tetryl. Most of the acidity is removed by washing with cold water. Treatment with boiling water decomposes any tetranitrocompound present and removes any products. If benzene is used as a solvent, the crude tetryl is dissolved, the solution is washed with water to remove residual acidity, and filtered to remove insoluble matter. Upon cooling the solution, the tetryl is precipitated, separated, and dried. If acetone is used as the solvent, the solution is neutralized and filtered and the tetryl is precipitated by mixing the solution with water. The acetone purification process is carried out on a continuous basis, while that with benzene is operated as a batch process. In the lab, high purity tetryl can be obtained by nitrating dimethylaniline with nitric acid, not mixed acid, in the presence of inert solvents such as dichloromethane, chloroform, or carbon tetrachloride.

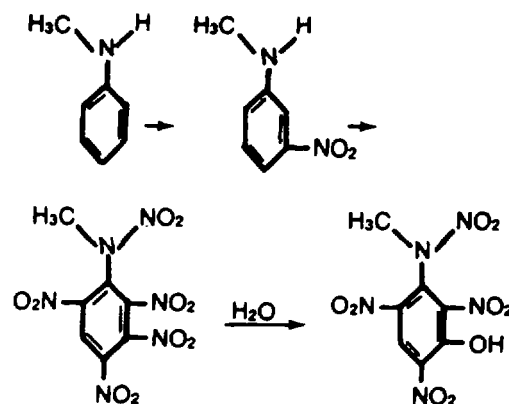

Figure 8-34. Nitration and hydrolysis of methylaniline.

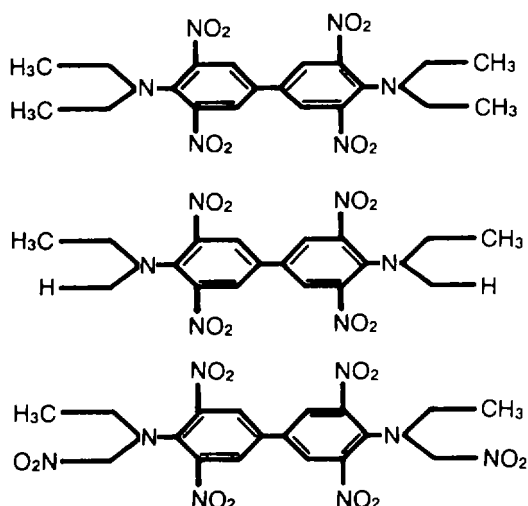

Figure 8-35. Benzidine derivatives during tetryl manufacture.

(8) One grade of tetryl is specified for military purposes. This complies with the following requirements:

Color: Light yellow
 Moisture and volatiles: Maximum, 0.10 percent
 Toluene insoluble matter: Maximum, 0.10 percent
 Grit: 3 particles
 Acidity: Maximum, 0.02 percent
 Melting point: Minimum, 128.8°C; maximum, 129.5°C

Granulation: Percent through US standard sieve:

No. 12, minimum	100
No. 16, minimum	95
No. 30, minimum	-
No. 40, maximum	-
No. 60, maximum	30
No. 100, maximum	5

A requirement also exists for an infrared spectrum with only certain specified peaks and no extraneous peaks. The requirement with respect to insoluble matter is included because of the marked desensitizing effect of

such impurities. Freedom from grit is required because of the affect of grit on sensitivity to impact and friction.

(9) Impact and rifle bullet tests indicate tetryl is more sensitive than TNT. The pendulum friction test, however, produces no detonations with the steel shoe. The explosion temperature test value of tetryl is much lower than that of TNT. For tetryl dropped on a heated copper surface the results in table 8-28 were reported.

Table 8-28. Heat Initiation of Tetryl

Temperature in °C	Time to explosion in seconds
302	0.4
280	1.1
260	2.0
236	6.2

Slightly different results were obtained with confined samples of tetryl. The explosion times for 25 milligrams of tetryl in copper shells of 0.635 millimeter diameter submerged in a hot woods metal bath are shown in table 8-29.

Table 8-29. Heat Initiation of Confined Tetryl

Temperature in °C	Time to explosion in seconds
360	0.325
346	0.425
329	0.582
285	1.45
269	2.22
264	Does not detonate

When a 0.5 gram sample of tetryl is heated at a rate of 20°C per minute, ignition occurs between 190°C and 194°C. If the temperature of a sample is held at 180°C ignition occurs in 40 seconds. The minimum primary charges necessary for reliable detonation of tetryl with mercury fulminate is 0.20 to 0.29 grams and with lead azide is 0.025 to 0.10 grams. Tetryl containing 60 percent water cannot be detonated by a commercial detonator. Shock sensitivity as measured by the gap tests are summarized in table 8-30.

Table 8-30. Gap Test Results for Tetryl

	Density grams per cubic centimeter	Percent voids	Sensitivity in millimeters
NSWC small scale gap test	1.687	2.5	7.80
	1.434	17.1	11.96
LANL small scale gap test	1.684 (pressed)	2.7	3.84
	1.676 (pressed)	3.1	4.04
	0.93 (bulk)	46.2	7.44
LANL large scale gap test	1.690 (not pressed)	2.3	59.82
	1.666 (pressed)	3.7	60.60
	0.85 (bulk)	50.9	69.2

The shock sensitivity of a lightly confined sample decreases as temperature decreases, but confined samples show only a slight tendency toward reduced shock sensitivity. Particle size has an effect on shock sensitivity. As the particle size decreases, the shock sensitivity increases. Deflagration can also be initiated by shock. For coarse tetryl with a density of 1.65 grams per cubic centimeter in a 21 millimeter diameter plexiglas tube, the deflagration threshold pressure is 12.1 to 14 kilobar, as compared to 18 kilobar for detonation. Tetryl's sensitivity to shock initiation by an explosive bridge wire is dependent on particle size and crystal habit. The sensitivity decreases as packing density increases. In studies of tetryl's sensitivity to initiation by laser beams, no initiation occurred upon direct exposure to the beam. But if the tetryl sample was coated with a thin metal film, initiation was observed at a density of 1.08 grams per cubic centimeter. With higher density tetryl no initiation occurred.

(10) At a density of about 1.60 grams per cubic centimeter, the sand test indicates a brisance of 113 to 123 percent of TNT, the copper cylinder compression test indicates 117 to 125 percent, the lead block compression test indicates 112 percent, the plate dent test indicates 115 percent, and the fragmentation effect test indicates 121 percent. The ideal detonation velocity as a function of density is given by the equation:

$$D=5600+3225(p-1)$$

where D, the detonation velocity, is in units of meters per second and p, the density, is in grams per cubic centimeter. This equation yields slightly higher values than have been observed by other researchers. Low velocity detonation has been observed when coarse tetryl is weakly initiated. Below a certain diameter, which varies with particle size, low velocity detonation can be stable for lengths up to 25 charge diameters. Above this diameter low velocity detonation is stable for only distances of 2 to 4 charge diameters, at which point

there is a transition to normal detonation velocity. Table 8-31 summarizes the dependence of transition diameter, minimum diameter for low velocity detonation, minimum diameter for normal detonation, and the approximate speed for low velocity detonation on particle size for 0.9 grams per cubic centimeter tetryl. Low velocity detonation is not affected by the initiating power of the detonator, provided the detonator is weak enough not to initiate normal detonation. For charge diameters between the minimum diameter for low velocity detonation and minimum diameter for normal detonation, even powerful initiators will produce only steady, low velocity detonation, provided the charge is of sufficient strength. Low velocity detonation is maximum at the transition diameter. This velocity is virtually independent of particle size and even type of explosive. TNT, PETN, RDX, and tetryl all have the same maximum low velocity detonation. Experiments with oil coated or crushed particles suggest that the main reaction in low velocity detonation is surface combustion. The power of tetryl by the ballistic pendulum test is 145 percent that of TNT, by the ballistic mortar test 126 to 132 percent of TNT, and by the Trauzl test 125 to 145 percent of TNT. The heat of detonation as a function of density is given by the equation:

$$Q=680+282p$$

where Q is in units of calories per gram and p, the density, is in grams per cubic centimeter. The values given by the above equation fall short of the computed values for an ideal detonation. Point initiation studies with tetryl at a density of 1.51 grams per cubic centimeter indicate that the radius of curvature of the detonation front increases with charge length in the manner expected for spherical expansion of the front. The radius of curvature is also a function of the particle size and packing density of the explosive. The apparatus shown in figure 8-36 was used to study the deflagration to

detonation transfer in tetryl. After ignition, the length of the column before detonation occurs is determined by the markings on the tube fragments recovered. This result is checked with the ionization probe and strain gage records for consistency. The results for coarse tetryl with a particle size of 470 microns and fine tetryl with a particle size of 20 microns are plotted in figure 8-37. According to the graph, both fine and coarse tetryl show the same effects of compaction on predetonation column length, which is nearly constant at low density, with increasing values at 75 percent density. At a given density, the fine tetryl has a greater predetonation column length than the coarse, as well as longer relative time to detonation. In the experiments with tetryl, the ionization probes frequently failed to respond because the decomposition products formed shortly after ignition have such a high electrical resistance. Another unique characteristic of tetryl is that the onset of accelerated burning is located nearer to the onset of detonation than

the ignition region. Both of these effects are attributed to the low temperature of decomposition of tetryl. The addition of 3 percent wax to a sample changes the initial low temperature decomposition to behavior typical of other explosives, with accelerated burning starting sooner. The burning rate of tetryl is not greatly affected by the initial temperature of the sample; the rate increasing by less than a factor of two for a temperature difference of 100°C. The burning rate decreases with additions of small amounts of water, and increases with increasing ambient pressure.

(11) Figure 8-38 shows the amount of gas evolved by tetryl as a function of temperature and time. The presence of picric acid tends to accelerate the evolution of gas, while trinitroanisole or trinitroaniline tend to slow the evolution of gas. Table 8-32 shows the composition of the gaseous products of tetryl decomposition.

Table 8-31. Low Velocity Detonation in Tetryl

Particle size in millimeters	Minimum diameter for low velocity detonation	Minimum diameter form normal detonation in millimeters	Transition diameter in millimeters	Minimum low velocity detonation in kilometers per second	Maximum low velocity detonation in kilometers per second
0.5	7	13	13	1.4	2.1
0.8	9	15	16	1.3	2.3
1.3	12	20	21	1.3	2.2

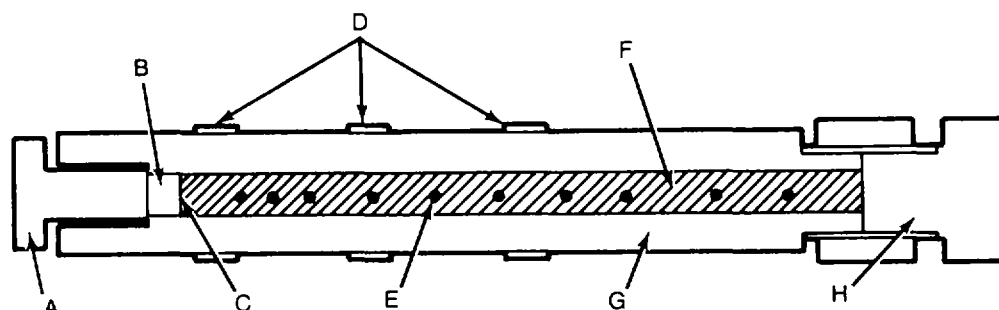

- A - IGNITER BOLT
- B - IGNITER
- C - IGNITER/EXPLOSIVE INTERFACE
- D - STRAIN GAGES
- E - IONIZATION PROBE LOCATION
- F - EXPLOSIVE CHARGE
- G - TUBE
- H - BOTTOM CLOSURE

INNER DIAMETER = 16.3MM

OUTER DIAMETER = 50.8MM

DISTANCE FROM IGNITER/EXPLOSIVE INTERFACE TO BOTTOM CLOSURE = 295.4MM

Figure 8-36. Deflagration to detonation transfer apparatus.

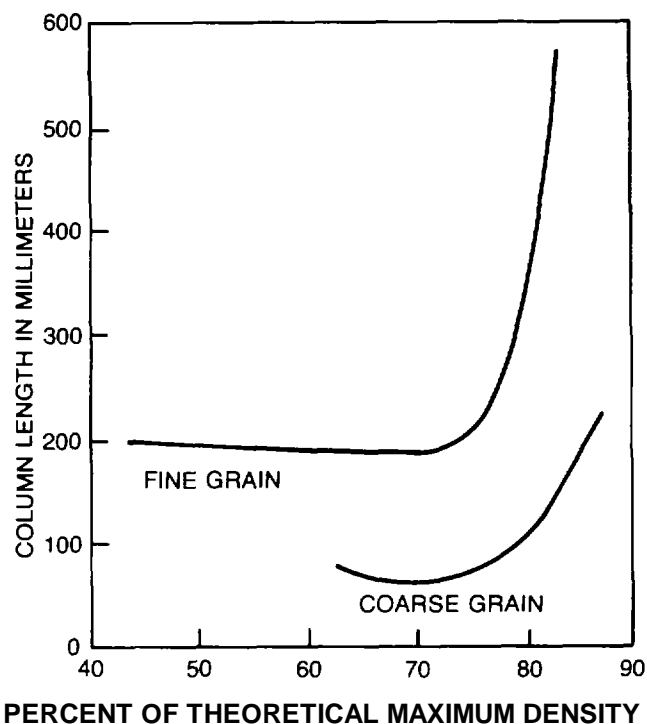

Figure 8-37. Effect of compaction on predetonation column length in tetryl.

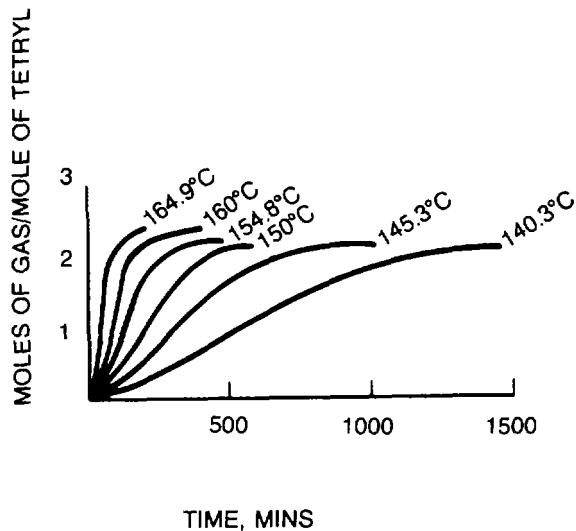

Figure 8-38. Kinetic gas-evolution curves in the decomposition of tetryl.

Table 8-32. Composition of Gaseous Products of Tetryl Decomposition

Time mins	Moles of gas per mole of tetryl	Composition of dry gas volume %				Composition of gas, moles per mole of tetryl				
		CO ₂	CO	NO	N ₂	CO ₂	CO	NO ₂	NO	N ₂
221	0.650	23.6	10.6	4.3	61.5	0.134	0.060	0.016	0.024	0.348
1530	2.208	25.9	12.0	5.3	56.8	0.493	0.229	0.000	0.101	1.080
40	0.450	25.1	10.9	5.0	59.0	0.087	0.035	0.021	0.017	0.204
50	0.667	24.5	11.3	6.3	57.9	0.124	0.057	0.018	0.032	0.282
80	1.338	23.9	11.1	8.2	56.8	0.243	0.113	0.031	0.084	0.578
110	1.808	24.3	10.8	8.1	56.8	0.358	0.158	-	0.118	0.838
140	2.010	25.2	11.5	8.5	54.8	0.420	0.193	0.016	0.143	0.925
200	2.149	25.1	11.8	8.6	54.5	0.448	0.210	0.004	0.153	0.972
422	2.304	25.7	12.1	8.2	54.0	0.491	0.231	0.001	0.156	1.030
1440	2.674	27.8	13.4	8.4	50.4	0.624	0.302	0	0.190	0.130
40	1.950	24.5	11.6	8.8	55.1	0.397	0.188	0.023	0.142	0.892
382	2.572	27.7	12.7	9.6	50.0	0.584	0.268	0.003	0.202	1.060

Table 8-33 shows the composition of the condensed phase as a function of time for tetryl that has been heated at 160°C.

Table 8-33. Composition of Condensed Phase Tetryl

Time mins	Weight of residue as % of initial quantity of tetryl	Moles per mole of tetryl			
		Tetryl	2, 4, 6- trinitroanisole	Picric Acid	N-methyl-2, 4, 6- trinitroanalline
25	95.6	0.832	0.073	0.037	0.030
45	90.0		0.195		0.034
55	86.9	0.494	0.265	0.094	0.045
70	83.8		0.295	0.113	
90	80.5	0.227	0.412	0.131	0.072
111	78.2		0.503		
145	75.9	0.029	0.525	0.160	0.065
300	74.2	0.019	0.478	0.204	0.047
400	73.2		0.463		
1440	69.0	0	0.110	0.524	0.031

The heat of reaction for the slow decomposition of tetryl is 328 to 341 calories per gram. Vacuum stability tests show tetryl to be less stable than TNT. The DTA curve for tetryl is shown in figure 8-39 and the TGA curve is shown in figure 8-40. Ammunition that has been loaded with tetryl cannot be stored at temperatures greater than 125°. This is specifically why the United States has discontinued the use of this explosive. Tetryl corrodes steel heavily. Slight corrosion is reported for iron, zinc, zinc plated steel, tin plated steel, parkerized steel, brass, and monel metal. Tetryl does not react with copper, tin, nickel, lead, copper plated steel, bronze, stainless steel, cadmium, aluminum, silver, and titanium. Tetryl frequently is used with one to two percent of a binding agent or lubricant, such as graphite, stearic acid, or magnesium stearate; and has been found to be compatible with such materials as well as black powder.

8-4. Nitroaromatics. Compounds in this class are prepared by C-type nitration in which a nitrogroup is attached to a carbon atom of the compound being nitrated.

a. Ammonium Picrate.

(1) This explosive is also known as ammonium 2,4,6-trinitrophenolate, explosive D, and Dunnite. The compound (figure 8-41) has a nitrogen content of 22.77 percent, an oxygen balance to CO₂ of 52 percent, a maximum crystal density of 1.717 grams per cubic centimeter, a nominal density of 1.63 grams per cubic centimeter, a melting point with decomposition of about 280°C and a molecular weight of 246. Ammonium picrate exists in a stable form as yellow,

monoclinic crystals and a meta stable form as red, orthorhombic crystals. The unit cell dimensions are a =13.45 Angstroms, b =19.74 Angstroms, and c =7.12 Angstroms. The compound manufactured for military use is yellow to orange in color. Table 8-34 lists the density of ammonium picrate as a function of loading pressure.

Table 8-34. Density of Ammonium Picrate

Pressure in kilopascals	Pressure in pounds per square inch	Density in grams per cubic centimeter
20,685	3,000	1.33
34,475	5,000	1.41
68,950	10,000	1.47
82,740	12,000	1.49
103,425	15,000	1.51
137,900	20,000	1.53
344,750	50,000	1.59
689,500	100,000	1.64

The refractive index at 20°C is: alpha, 1.508; beta, 1.870; and gamma, 1.907. The heat of combustion of ammonium picrate at constant pressure is 2,745 calories per gram, from which is derived a heat of formation value of 95.82 kilogram-calories per mole. The heat of explosion is 706 calories per gram. Table 8-35 lists the solubility of ammonium picrate in various solvents as a function of temperature.

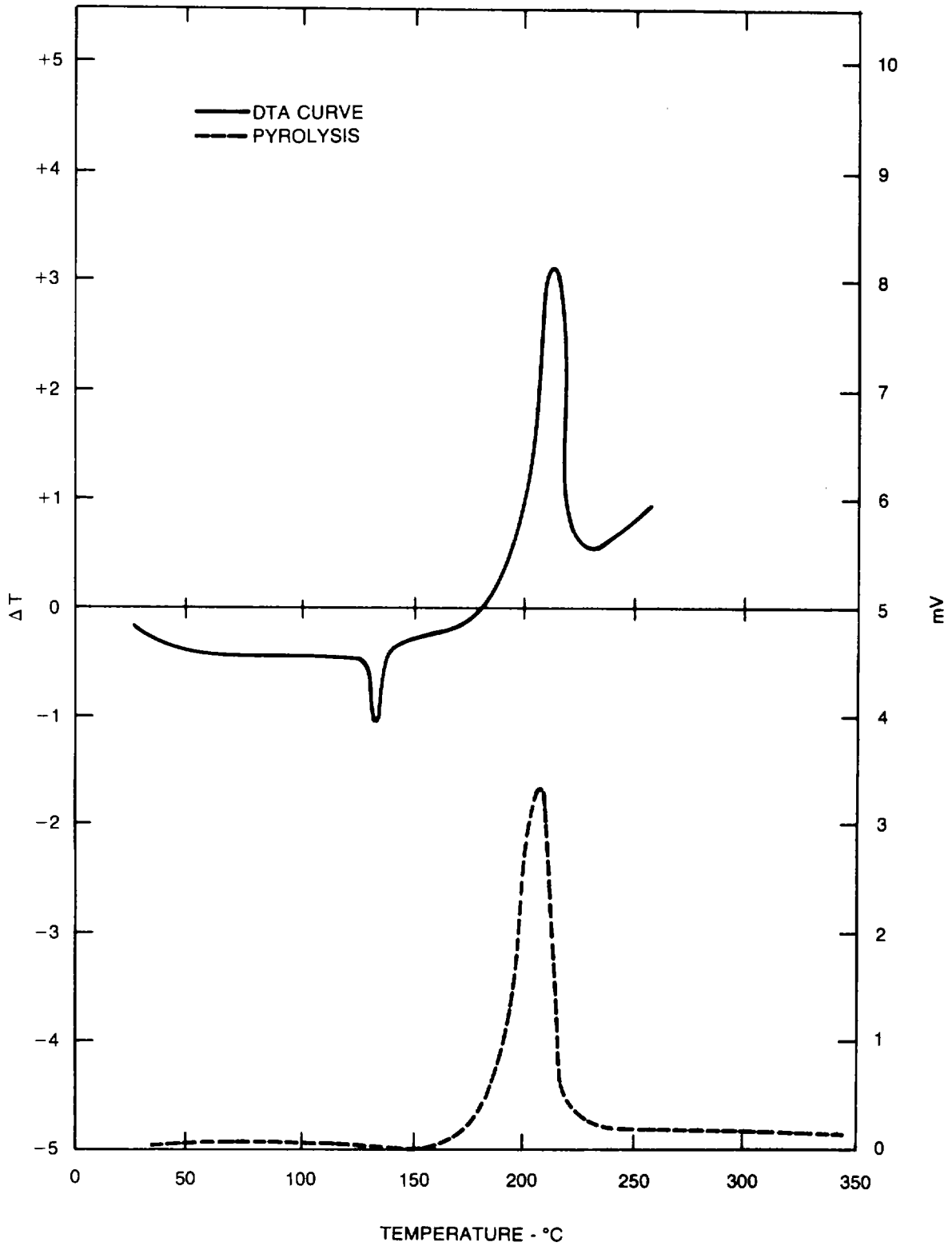

Figure 8-39. DTA curve for tetryl.

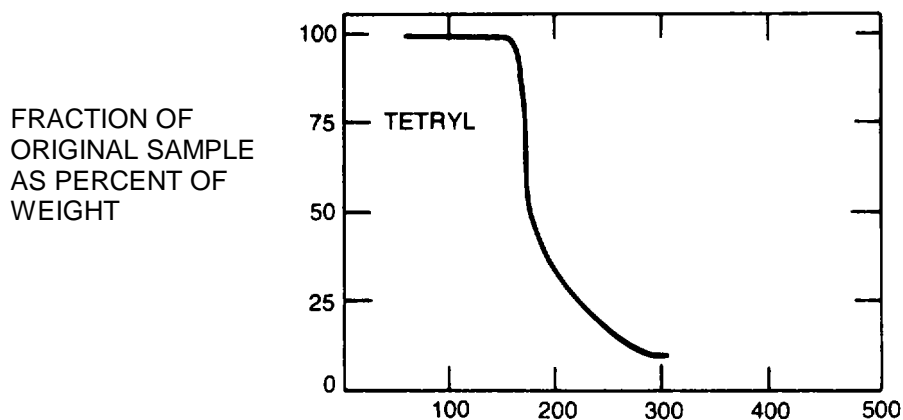

Figure 8-40. TGA curve for tetryl.

Table 8-35. Solubility of Ammonium Picrate

Solvent	Solubility in grams per 100 grams of solvent						
	0°C	10°C	20°C	30°C	50°C	80°C	100°C
Water	-	0.70	102	-	-	-	75
Ethanol	0.51	0.69	0.86	1.05	1.89	3.62	-
Ethyl acetate	0.29	0.30	0.34	0.38	0.45	0.56	-
Acetone	-	-	-	2.85	-	-	-
Octyl alcohol	-	-	0.2	-	-	-	-
	-	-	at	-	-	-	-
	-	-	25°C	-	-	-	-

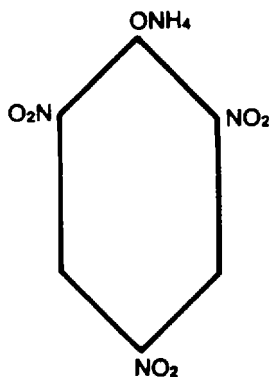

Figure 8-41. Structural formula for ammonium picrate.

In ethanol, ammonium picrate dissolves very slowly and slow separation occurs when the solution is left standing. The solubility in ether is very slight. Ammonium picrate, because of an extreme insensitivity to shock, is used in armor piercing projectiles. The compound is also used in jet assisted takeoff units for aircraft.

(2) Chemically, ammonium picrate is not very reactive. Decomposition by alkalis yields picric acid and ammonia. This reaction is the basis of one of the methods for determining the purity of the material. When maintained at the melting point, ammonium picrate decomposes to the same products. At 0°C an equimolecular amount of ammonia is absorbed, but at 26°C this is lost by volatilization.

(3) The manufacture of ammonium picrate is relatively simple. Picric acid, which is only partially soluble in water, is suspended in hot water and neutralized by the addition of gaseous or aqueous ammonia. The picrate, which is more soluble in water, is formed and immediately goes into solution. The reaction is slightly exothermic. On cooling the solution, the ammonium picrate separates out. If a marked excess of ammonia is used, the red form is obtained so care must be taken to avoid this and obtain the yellow form. The yellow form has a higher bulk density than the red and can be pressed better. The separated crystals are washed with cold water to remove any free ammonia present and then dried.

(4) The specifications for ammonium picrate cover one grade of material representing two classes with respect to granulation. Class 1 material, which is the coarser of the two classes, is intended for use in the

press-loading of shells, while class 2 is used for the manufacture of picratol and other compositions. The requirements are as follows:

	Class 1	Class 2
Surface moisture and volatile content (%), maximum:	0.10	
Total moisture content (%), maximum:	-	0.2
Ammonium picrate purity (%), minimum:	99	99
Sulfates (as sulfuric acid) (%), maximum:	0.10	0.10
Chloroform insoluble impurities (%), maximum:	0.10	-
Water insoluble material (%), maximum:	0.10	0.10
Irritant contaminants as parts chlorine per million, maximum:	50	-
Ash (%), maximum:	0.1	0.1
Acidity and alkalinity (as picric acid or ammonia (%), maximum:	0.025	0.025
Color	Yellow to orange	Yellow to
Granulation (US standard sieves)		
Percent through No. 12 sieve, minimum	99.9	-
Percent through No. 40 sieve, minimum	-	99.5
Percent retained on No. 70 sieve, minimum	60	-
Percent retained on No. 70 sieve, maximum	-	20
Percent through No. 200 sieve, maximum	5	-

The picric acid used to make class 2 ammonium picrate shall be made by the nitration of phenol and shall contain no material salvaged from trimmings or from loading operations. Class 2 ammonium picrate shall contain no reworked ammonium picrate made by way of any process other than the phenol nitration process. The irritant contaminants requirement is not applicable to ammonium picrate made from picric acid produced by the nitration of phenol. The color requirement is intended to cover the unavoidable presence of a small amount of the red form of ammonium picrate in admixture with the yellow form. The requirement with respect to irritant contaminants represents a control of the purity of picric acid used in manufacture when this is made by the dinitrochlorobenzene process. The chloroform soluble matter requirement also represents a control of the nature of impurities present in picric acid manufactured by a process other than the nitration of phenol.

(5) Ammonium picrate is distinctly less sensitive to impact than TNT and is unaffected by the steel shoe in the pendulum friction test. A slightly greater sensitivity is indicated by the rifle bullet impact test with three partially burned samples in ten trials. This is attributed to the lower temperature required for explosion for ammonium picrate, 318°C in the five second test, as opposed to 457°C for TNT. The time to

explosion as a function of temperature is shown in table 8-36.

Table 8-36. Ammonium Picrate Explosion Temperature

Time in seconds	Temperature in degrees centigrade
0.1	405
1	367
5	318
10	314
15	299
20	295

The low degree of sensitivity of ammonium picrate to impact is paralleled by a relative insensitivity to initiation. In the sand test, ammonium picrate is not detonated completely by either lead azide or mercury fulminate. A booster charge of 0.06 gram of tetryl is required for complete detonation. In this test, a minimum charge of 0.28 gram of diazodinitrophenol detonates ammonium picrate but a charge of only 0.15 gram is required for the detonation of TNT. The minimum charge of mercury fulminate required to initiate 0.4 grams of ammonium

picrate loaded at about 200 atmospheres of pressure is 0.85 grams versus 0.26 grams of mercury fulminate necessary to initiate 0.4 grams of TNT. Moisture has a marked effect on the sensitivity of ammonium picrate to initiation. The presence of 0.5, 1.0, and 2.0 percent of moisture requires increases in the minimum detonating charge of tetryl to 0.09, 0.11, and 0.14 gram, respectively. Storage of either the yellow or red form at 50°C for two years causes such an increase in sensitivity that initiation by mercury fulminate alone is possible. Subsequent storage of the yellow form at magazine temperatures for two years causes desensitization to such an extent that a booster charge to tetryl is required for complete detonation and four years of such storage is required for return to the original condition of insensitivity. Storage at 50°C has the same effect on the sensitivity of red ammonium picrate but subsequent storage at magazine temperatures for four years merely increases the minimum detonating charge of mercury fulminate from 0.23 to 0.29 gram. The changes in sensitivity are not accompanied by any change in brisance or in color. In an electrostatic sensitivity test for material that passes through a 100 mesh sieve, an energy of 6.0 joules was required for confined material and 0.025 joules for unconfined material. Ammonium picrate which has been pressed into and removed from projectiles or other ammo is much more sensitive to shock than new or unused material. Therefore, reclaimed material should not be pressed or loaded into ammo items until after recrystallization.

(6) In the sand test, 37.5 grams to 39.5 grams of sand are crushed, which indicates a brisance of 78 to 82.5 percent of TNT. The plate dent test indicates a brisance of 91 percent of TNT for a charge of ammonium picrate with a density of 1.50 grams per cubic centimeter. Fragmentation tests indicate a brisance of 91 percent, 96 percent and 99 percent of TNT for charges that have been pressed to density values of 1.50, 1.53, and 1.55, respectively. The approximate velocity of detonation as a function of density is given by the equation:

$$V = 960 + 3800d$$

where V is in meters per second and d, the density, is in grams per cubic centimeter. A charge diameter of 2.54 centimeters was used to determine the above equation.

The critical diameter for a sample with density of 1.65 grams per cubic centimeter is greater than 25.4 millimeters. When exploded adiabatically at constant volume, ammonium picrate produces a pressure of 8956 kilograms per square centimeter when pressed to a density of 1.5 grams per cubic centimeter, and 9553 kilograms per square centimeter when pressed to a density of 1.6 grams per cubic centimeter. These values are 113 percent of the corresponding values for TNT. Although the heat of explosion of ammonium picrate is only 86 percent that of TNT, the ballistic pendulum test indicates a power of 98 percent of TNT. This combination of brisance and power, almost equal to those of TNT, together with relative insensitivity, has made ammonium picrate suitable for use in armor piercing projectiles. However, the impracticality of melt-loading ammonium picrate has led to partial replacement by picratol, which can be melt-loaded. When ignited in an unconfined state, ammonium picrate burns slowly without detonation emitting dense, black smoke. However, when confined and heated to the ignition temperature, an explosion occurs. Complete detonation produces a dense, black cloud of smoke with sooty deposits and an odor of ammonia. When incomplete detonation occurs, yellow smoke is produced along with unburned ammonium picrate particles.

(7) Ammonium picrate is of a very high order of stability. In the 100°C heat test, 0.1 percent is lost in the first 48 hours and 0.1 percent in the second 48 hours. No explosions occur in 100 hours. In the 130°C heat test there is no acidity or explosion in 300 minutes. The vacuum stability test at 100°C produced 0.2 cubic centimeters of gas in 40 hours, at 120°C, 0.4 cubic centimeters of gas are produced, and at 150°C, 0.4 cubic centimeters of gas are produced. The material has been found to withstand storage at ordinary temperatures for a period of twenty years with no evidence of deterioration, and at 50°C for more than five years without marked deterioration. Moisture increases ammonium picrate's reactivity with metals such as lead, potassium, copper, and iron. The compounds produced are extremely sensitive. This reactivity requires that all projectiles loaded with this material have contact areas covered with acid proof paint. At 100°C ammonium picrate is compatible with TNT or black powder but undergoes reactions with nitroglycerin, nitrocellulose, PETN, or tetryl. Figure 8-42 shows the DTA curve for ammonium picrate.

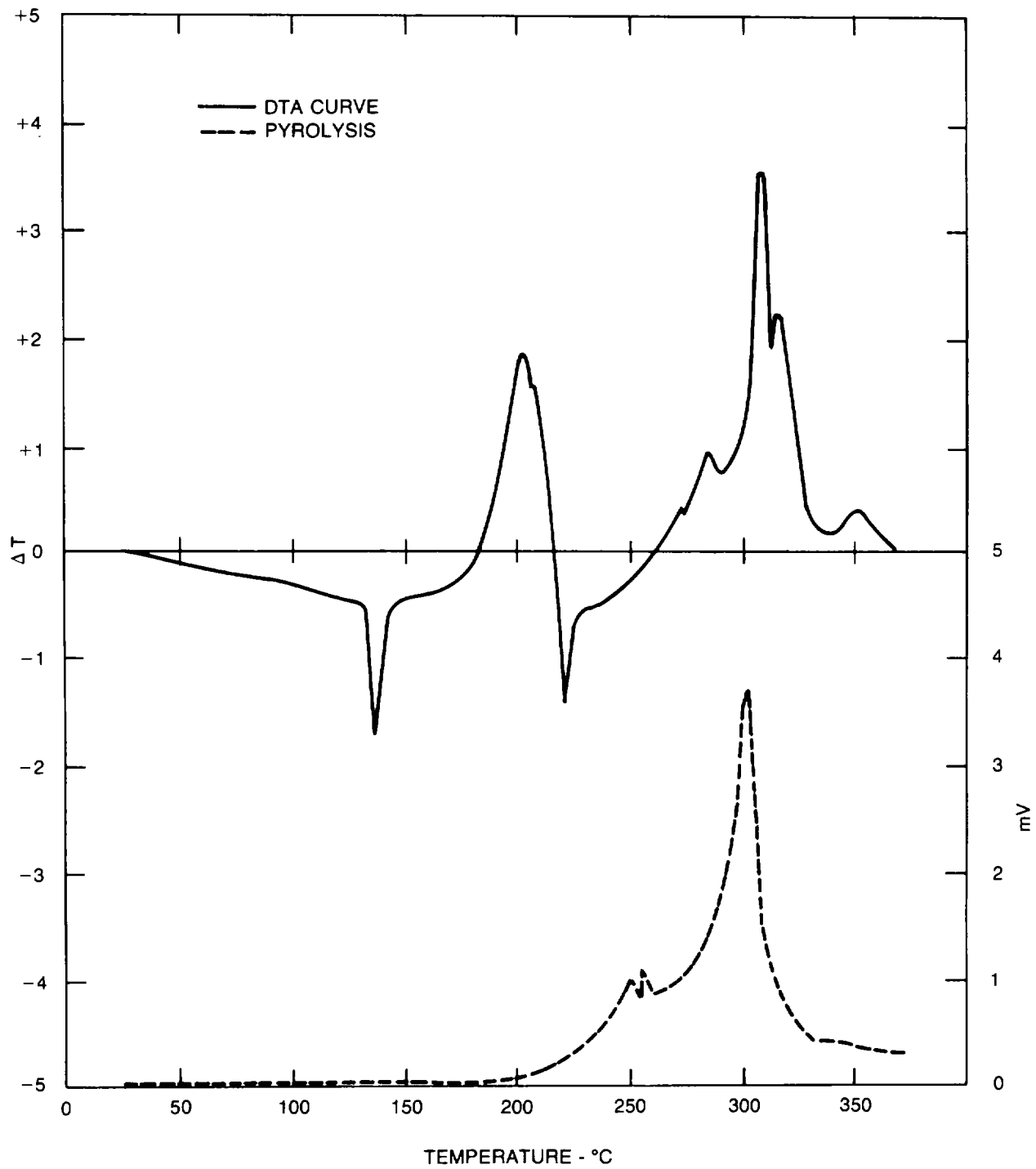

Figure 8-42. DTA curve for ammonium picrate.

b. 1,3-Diamino-2,4,6-Trinitrobenzene (DATB).

(1) This explosive is also known as 2,4,6-trinitro-1,3-diaminobenzene; 2,4,6-trinitro-7,3-benzenediamine trinitro-m-phenylenediamine; or 2,4,6-trinitro-1,3-diaminobenzol and may be referred to as DATNB. The compound (figure 8-43) is a yellow, crystalline solid with a nitrogen content of 28.81 percent, a melting point of 286°C to 301°C with decomposition, and a molecular weight of 243.14. Two polymorphs of DATB have been identified. Form I, which is stable to 217°C, has two molecules per unit cell and unit cell lengths of a=7.30 Angstroms, b=5.20 Angstroms, c = 11.63 Angstroms. Form II has four molecules per unit cell and unit cell lengths of a=7.76 Angstroms, b =9.04 Angstroms, c = 12.84 Angstroms. The maximum density of form I is 1.837 grams per cubic centimeter and the density of form II is 1.815 grams per cubic centimeter. The nominal density of DATB is 1.79 grams per cubic centimeter. DATB is slightly soluble in acetic acid and only very slightly soluble in other solvents. The vapor pressure is given by the equation:

$$\log p = 12.75 - 7492/T(^{\circ}\text{C})$$

for 92.8°C < T < 176.8°C

The heat of formation is 97.1 to -119 calories per gram, the heat of combustion is 7115 kilocalories per mole, the heat of detonation with liquid water was experimentally determined as 980 calories per gram and with gaseous water, 910 calories per gram. The computed maximum values for the heat of detonation

are 1260 calories per gram and 1150 calories per gram for gaseous and liquid water, respectively. The specific heat is given by the equation:

$$C_p = 0.20 + (1.11 \times 10^{-3})T - (1.81 \times 10^{-6})T^2 \text{ for } 47^{\circ}\text{C} < T < 200^{\circ}\text{C}$$

The heat of sublimation is 138 calories per gram. DATB can be used as a pressed explosive or as a ballistic modifier in some rocket propellants.

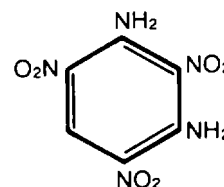

Figure 8-43. Structural formula for DATB.

(2) DATB can be prepared by nitrating m-dichlorobenzene to 2,4,6-trinitro-1,3-dichlorobenzene and aminating in methanol solutions. Another method of preparation is by the amination of 2,4,6-trinitro-3-aminoanisole. In a third method of preparation phosphorous oxytrichloride and dipyridinium styphnate are reacted directly at steam bath temperature and a suspension of the resulting 2,4,6-trinitro-1,3-dichlorobenzene in methanol is treated with gaseous ammonia. Impact sensitivity is 200 percent that of TNT. Table 8-37 shows the gap test results for DATB.

Table 8-37. Gap Test Results for DATB

	Density grams per cubic centimeter	Percent voids	Sensitivity in millimeters
NSWC small scale gap test	1.775	3.5	3.28
	1.233	33	5.18
LANL small scale gap test	1.801 (hot pressed)	2.0	0.36
	1.714 (pressed)	6.7	1.27
LANL large scale gap test	1.786 (pressed)	2.8	41.68
	1.705 (pressed)	7.2	45.36
	0.81 (bulk)	56	49.3
PX gap test	1.781	3.2	17.86
	1.446	21.3	19.94

(3) The detonation velocity is given by the equation:

$$D = 2.480 + 2.852p$$

where D is in kilometers per second and p, the density, is in grams per cubic centimeter. The failure diameter of unconfined DATB at a density of 1.816 grams per cubic centimeter is 5.3 millimeters. The detonation pressure is 251 and 259 kilobars for samples with densities of 1.780 and 1.790 grams per cubic centimeter, respectively. The plate dent test indicates a brisance of 120 percent of TNT.

(4) In the vacuum stability test, less than 0.03 cubic centimeters of gas are evolved in 48 hours at 120°C. In the LLNL reactivity test, less than 0.03 cubic centimeters of gas are evolved per 0.25 grams of

sample in 22 hours at 120°C. Figure 8-44 shows the DTA curve for DATB.

c. *2,2',4,4',6,6'-Hexanitroazobenzene (HNAB)*.

(1) This explosive is also known as bis (2,4,6trinitrophenyl)-diazene. HNAB forms blood red prisms when crystallized from nitrobenzene, glacial acetic acid, or concentrated nitric acid. The compound (figure 8-45) has a melting point of 215°C to 216°C, a molecular weight of 452, and a density of 1.79 grams per cubic centimeter. HNAB has a heat of formation of -58 to -67.9 calories per mole and a heat of detonation of 1.47 kilocalories per gram for liquid water and 1.42 kilocalories per gram for gaseous water. The specific heat is 0.3 calories per gram per degree centigrade. Table 8-38 shows the gap test results for HNAB.

Table 8-38. Gap Test Results for HNAB

	Density in grams per cubic centimeter	Percent voids	Sensitivity in millimeters
NSWC small scale gap test	1.774	-	6.38
	1.383	-	12.04
LANL small scale gap test	1.601 pressed	-	5.6

(2) One method of obtaining HNAB is to treat picryl chloride, $(\text{NO}_2)_3\text{C}_6\text{H}_2\text{Cl}$, with hydrazine, $\text{H}_2\text{N.NH}_2$, to obtain hexanitrohydrazobenzene. The hexanitrohydrazobenzene is then oxidized by nitric acid or nitrogen oxide gas in a glacial acetic acid solution to HNAB. The nitrogen oxide gas is obtained from the reaction of nitric acid and As_2O_3 . Another method of obtaining HNAB also involves two steps. The first step is to suspend a mixture of dinitrochlorobenzene, $(\text{NO}_2)_2\text{C}_6\text{H}_3\text{Cl}$, with hydrazine in hot water that contains sodium or calcium carbonate to form tetranitrohydrazobenzene, $(\text{NO}_2)_2\text{C}_6\text{H}_3\text{NH.HN.C}_6\text{H}_3(\text{NO}_2)_2$. The second step is to treat the tetranitrohydrazobenzene with concentrated nitric acid. The nitric acid introduces the two required NO_2 groups and also oxidizes the $-\text{NH.HN}$ group to an $-\text{N}=\text{N}$ group to form HNAB.

(3) HNAB is a very powerful and brisant high explosive. At a density of 1.77 grams per cubic centimeter, the detonation velocity is 7250 meters per second. Power, by the Trauzl test, is 123 percent of TNT. The DTA curve for HNAB is shown in figure 8-46.

d. *Hexanitrostilbene (HNS)*.

(1) This explosive is also known as hexanitrodiphenylethylene or 1,2 bis-(2,4,6-trinitrophenyl)ethylene or 1,1'-(1,2-ethenediyl) bis-(2,4,6trinitrobenzene). The compound (figure 8-47) forms yellow needles when crystallized from nitrobenzene. HNS has a nitrogen content of 18.67 percent, a molecular weight of 450.24, and a melting point of 316°C. The theoretical maximum density of type I HNS is 1.740 grams per cubic centimeter with a nominal density of 1.72 grams per cubic centimeter. The crystals are orthorhombic with unit cell dimensions of $a=22.13$ Angstroms, $b=5.57$ Angstroms, $c=14.67$ Angstroms. At the melting point decomposition and explosions occur. The heat of formation is 13.9 to -18.7 kilocalories per mole, the heat of sublimation is 94.9 calories per gram, the heat of detonation with liquid water is 1.42 kilocalories per gram, and the heat of detonation with gaseous water is 1.36 kilocalories per gram. The specific heat is given by the equation:

$$C_p = 0.201 + (1.27 \times 10^{-3})T - (2.39 \times 10^{-6})T^2 \text{ for } 47^\circ\text{C} < T < 220^\circ\text{C}$$

where C_p is in calories per gram per degree centigrade.

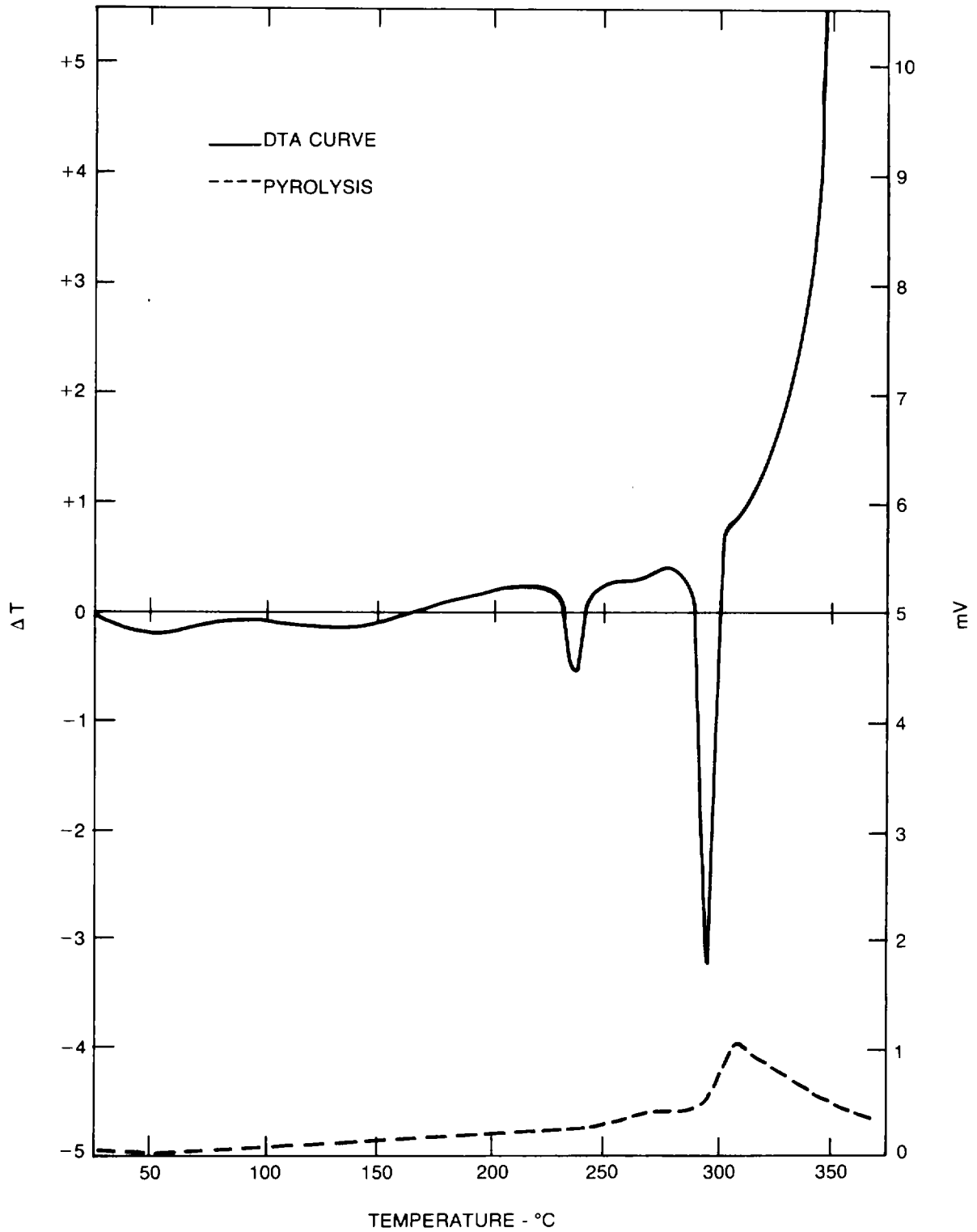

Figure 8-44. DTA curve for DATB.

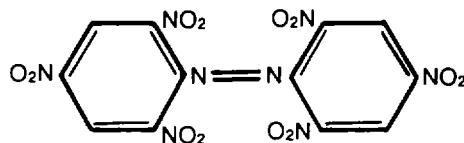

Figure 8-45. Structural formula for HNAB.

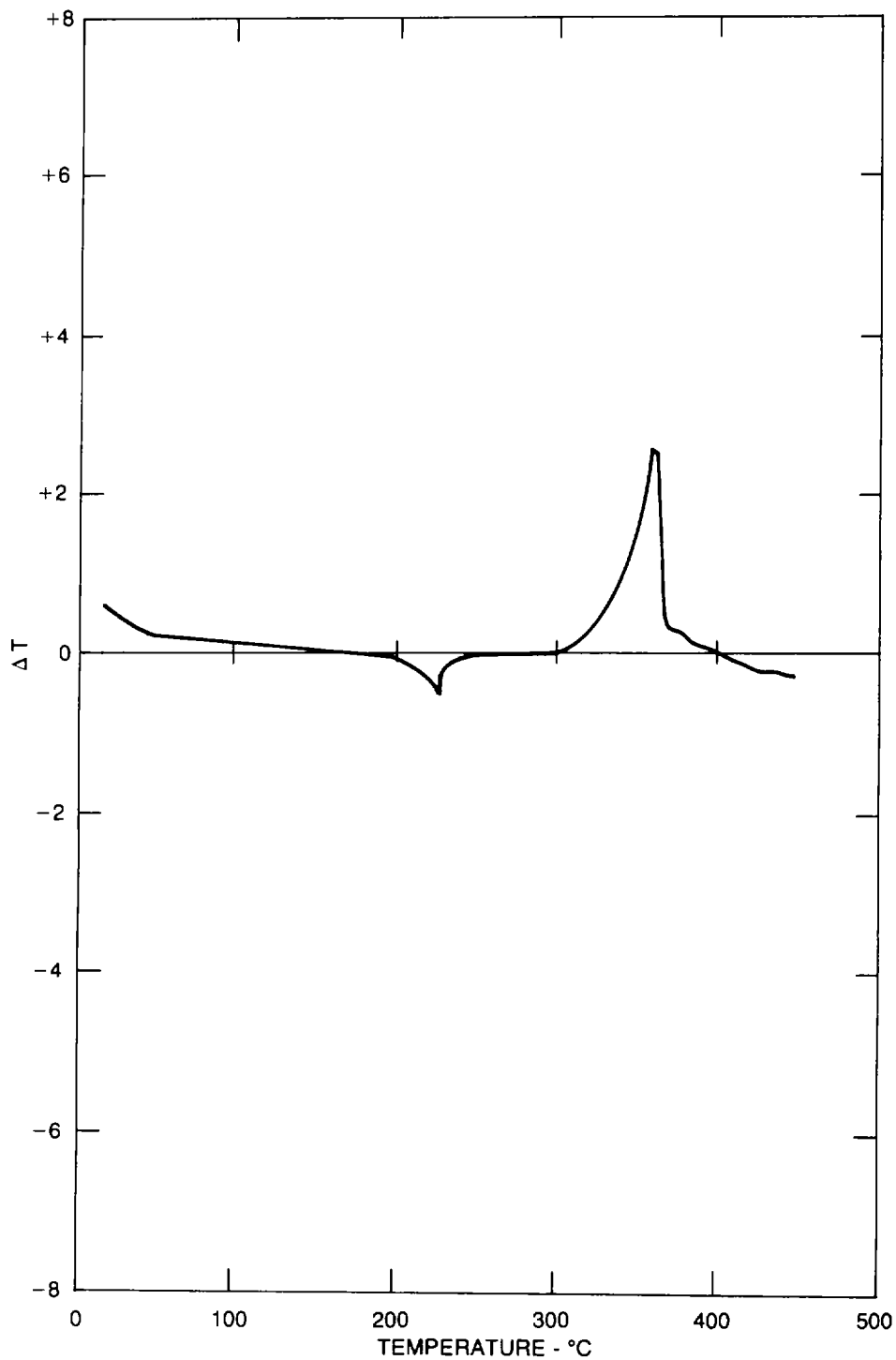

Figure 8-46. DTA curve for HNAB.

HNS is soluble in dimethyl formamide and slightly soluble in hot acetone, methylethyl ketone, and glacial acetic acid. HNS is used as a heat resistant booster explosive and has excellent properties for use in PBXs and mild detonating fuse end couplers and end boosters.

(2) HNS can be prepared from 2,4,6-trinitrobenzyl chloride by heating on a steam bath with methanol containing potassium hydroxide. HNS has a uniquely small critical diameter of about 0.5 millimeters (0.020 inch), is practically insensitive to electrostatic spark, is less sensitive to impact than tetryl, and is radiation resistant.

(3) Two types of HNS are manufactured, as shown in table 8-39.

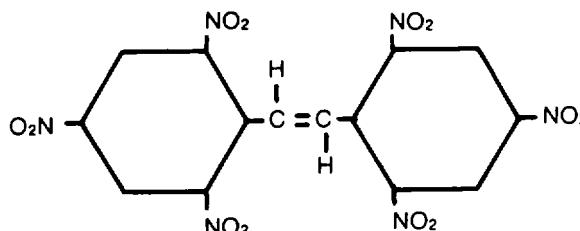

Figure 8-47. Structural formula for HNS.

Table 8-39. Properties of HNS

Property	Type I	Type II
Melting point, °C with decomposition	316	319
Particle size in microns	1-5	100-300
Bulk density in grams per cubic centimeter	0.32-0.45	0.45-1.0
Differential thermal analysis, onset of exotherm	315°C	325°C
Electrostatic spark sensitivity, fires above, in micro farads	0.001 at 8kv	0.0001 at 17kv
Friction sensitivity in kilograms per centimeter	440	440
Impact sensitivity in centimeters, Naval Ordnance Laboratory machine	44	61
Vacuum stability at 260°C in cubic centimeters per gram per hour:		
1st 20 minutes	1.8	0.3
Additional two hours	0.6	0.2
At 280°C	2.7	2.7
Velocity of detonation in meters per second at a density of 1.70 grams per cubic centimeter	7000	7000
Autoignition point	325°C	325°C
Decomposition rate at 260°C	0.1%/hour	0.1%/hour
Heat of combustion, calories per gram	3451	3451
Mean firing voltage for an explosive bridge wire with a one microfarad capacitor	12,950 at 0.9 grams per cubic centimeter	12,950 at 0.9 grams per cubic centimeter
Vapor pressure	2.9×10^{-8} torr at 160°C	2.9×10^{-8} torr 160°C

(4) HNS is half as sensitive to impact as TNT. Gap test results for HNS are shown in table 8-40.

Table 8-40. Gap Test Results for HNS

	Density in grams per cubic centimeter	Percent voids	Sensitivity in millimeters	
NSWC small scale gap test HNS I	1.694	2.6	5.18	
	1.122	35.5	7.06	
	HNS II	1.725	0.9	5.46
		1.644	-	7.52
		1.322	24	9.53
LANL small scale gap test HNS I	1.669	4.1	5.28	
	1.566	10	5.84	
	1.376	20.9	6.71	
	1.840 (pressed)	2.1	2.31	

(5) At a density of 1.70 grams per cubic centimeter, the velocity of detonation is 7,000 meters per second and the detonation pressure is 262 kilobars. The plate dent test indicates a power of 120 percent of TNT.

(6) In the 100°C heat test, HNS loses less than 1 percent weight in 48 hours. Less than one cubic centimeter of gas is evolved in the 100°C vacuum stability test. Figures 8-48 and 8-49 show the DTA and TGA curve for HNS, respectively.

e. *1,3,5Triamino-2, 4,6Trinitrobenzene (TA TB).*

(1) This explosive is also known as 2,4,6trinitro-1,3,5-benzenetriamine and may be referred to as TATNB. TATB (figure 8-50) has a nitrogen content of 32.56 percent, an oxygen balance to CO₂ of -55.78 percent, and a molecular weight of 258.18. TATB is yellow but exposure to sunlight or ultraviolet light causes a green coloration which, with prolonged exposure, turns brown. The compound has a theoretical maximum density of 1.937 grams per cubic centimeter and a nominal density of 1.88 grams per cubic centimeter. An instantaneous hot bar decomposition temperature of 450°C to 451 °C was reported with rapid thermal decomposition above 320°C. The structure of the crystalline lattice of TATB (figure 8-51) contains many unusual features. Some of these are the extremely long C-C bonds in the benzene ring, the very short C-N bonds, amino bonds, and the six furcated hydrogen bonds. Evidence of a strong intermolecular interaction, hydrogen bonds, in TATB is indicated by the lack of an observable melting point and very low solubility. The intermolecular network results in a graphite-like lattice structure with the resulting properties of lubricity and intercalation. Physical properties of the triclinic unit cell, which consists of two molecules, are a=9.010

Angstroms, b=9.028 Angstroms, c=6.812 Angstroms, and alpha=108.590, beta=91.82°, and gamma= 119.97°. Continuous monitoring of the cell constants of TATB between 214°K and 3770K allowed for the calculation of a volume change of +5.1 percent for this molecular system. Expansion of the pure material is almost exclusively a function of a 4 percent linear increase in the c axis, which is the perpendicular distance between sheets of hydrogen-bonded TATB molecules. The solubility of TATB is greater than 20 percent by weight per volume of solution in super acids such as concentrated sulfuric acid, chlorosulfonic acid, fluorosulfonic acid, and trifluoromethane sulfuric acid. Table 8-41 lists the solubility of TATB in various solvents.

Table 8-41. Solubility of TATB in Various Solvents

Solvent	Solubility, in parts per million
Methanesulfonic acid	820
Hexamethylphosphortriamide	150
Ethanesulfonic acid	120
DMSO	70
Hexafluoroacetone sesquihydrate	68
N-methyl-2-pyrrolidinone	58
N,N-dimethylacetamide	33
DMF	27
Tetramethylurea	26
Dimethyl methylphosphonate	22
N,N-dimethylpropionamide	16
Bis(dimethylamino)phosphochloridate	14
Gamma butyrolactone	14
Concentrated nitric acid	14

Table 8-41. Solubility of TATB in Various Solvents (Cont)

Solvent	Solubility, in parts per million
3-Methylsulfolane	13
Pyridine	12
Trimethylphosphate	11
Dimethylcyanamide, vinyl sulfone	8
Methyl dichlorophosphate	7
N-methylformamide	6
Methyl methanesulfonate	5
Trimethylphosphite	4
Acetone	3
Dimethyl carbamoyl chloride	3
Acetonitrile	3
Acetic anhydride	3
Trifluoroacetic acid	3
Acetic acid	1
Hexamethyldisilazane	less than 1
Trifluoroacetic anhydride	less than 1
Hexafluorobenzene	less than 1
Pentafluoropyridine	less than 1
Perfluoro-2-butyltetrahydrofuran	less than 1
Basic solvents:	
Tetramethylguanidine	485
Bu ₄ NOH, 25% in methanol	390
N,N,N',N'-Tetramethylglycinamide	67

At 131.40C and 171.30C TATB has vapor pressures of 10⁻⁷ torr and 10⁻⁵ torr, respectively. At 344,750 and 441,280 kilopascals (50,000 and 64,000 pounds per square inch) the loading density of TATB is 1.80 and 1.89 grams per cubic centimeter, respectively. Thermochemical characteristics include a heat of combustion of 735.9 kilocalories per mole, a heat of detonation with gaseous water at 1.87 grams per cubic centimeter of 1018 calories per gram, a heat of detonation with liquid water of 2831 calories per gram, and a heat of formation of -33.46 to -36.85 kilocalories per mole. The heat of sublimation is 155.7 calories per gram and the heat of reaction during self-heating is 600 calories per gram. The heat capacity as a function of temperature is given by the equation:

$$\text{Specific heat} = 0.215 + (1.324 \times 10^{-3}) T - (2 \times 10^{-6}) T^2$$

for 0°C < T < 300°C

The effects of gamma radiation are shown in table 8-42.

Table 8-42. Effects of Gamma Radiation on TATB

Amount of cobalt 60 radiation R	Density before irradiation in grams per cubic centimeter	Density of kv irradiation in grams per cubic centimeter	Detonation velocity in meters per second	Detonation pressure in kilobars	Explosion temperature in C
Control	1.84	-	7,510	260	403
1.0x10 ⁷	1.84	1.84	7,520	260	394
9.0x10 ⁷	1.85	1.84	7,525	261	370
7.4 x 10 ⁸	1.82	1.81	7,435	250	345

TATB is suitable for use in plastic explosives and in explosives mixtures with TNT that can be cast. The major military use is in special applications in warheads of high speed guided missiles. In this application energy

is sacrificed but handling safety is gained because the main charge remains inert under the service environments of high velocity impact and fire.

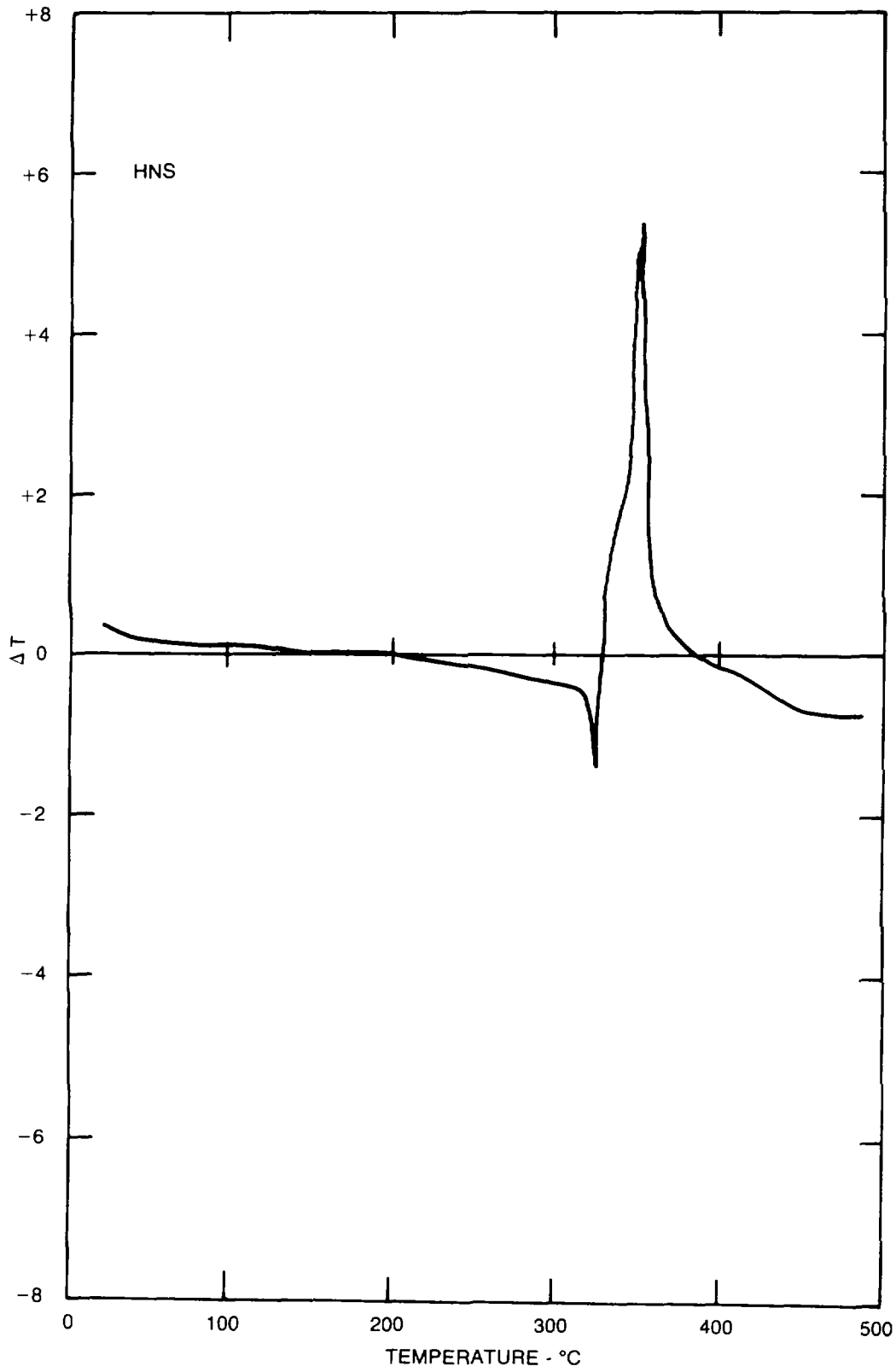
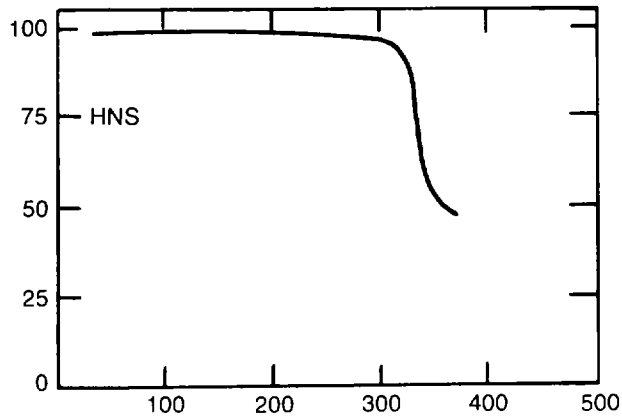

Figure 8-48. DTA curve for HNS.

FRACTION OF ORIGINAL SAMPLE AS PERCENT OF WEIGHT



TEMPERATURE IN °C

Figure 8-49. TGA curve for HNS.

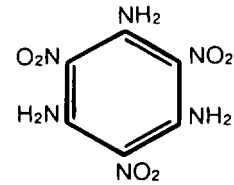

Figure 8-50. Structural formula for TATB.

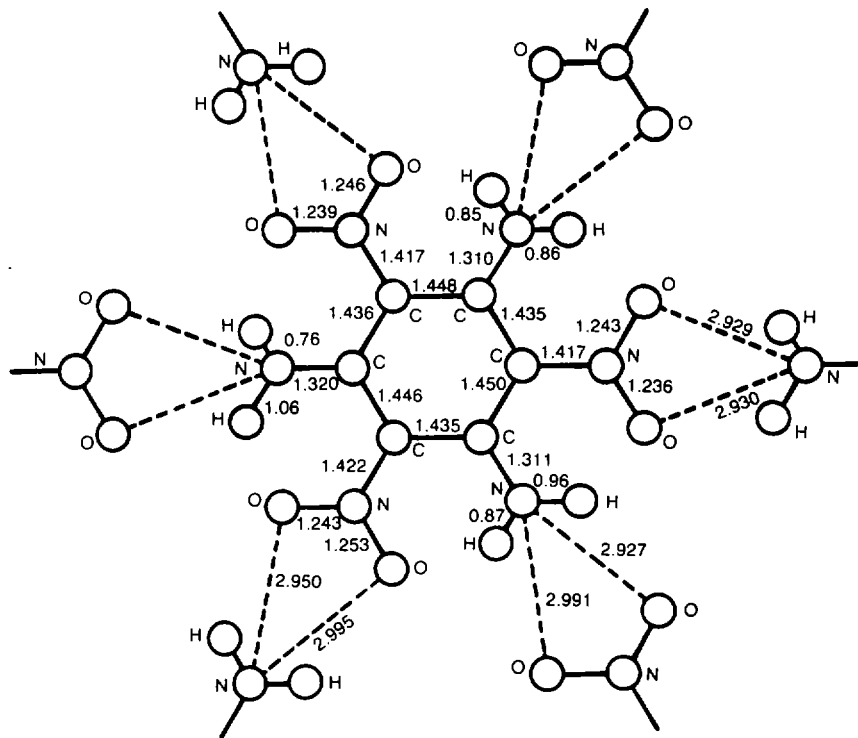

Figure 8-51. Configuration of the TATB molecule.

(2) The preferred method of preparation in the laboratory consists of the nitration of s-trichlorobenzene with a mixture of nitric acid and oleum at a temperature of 150°C for three hours. A toluene solution of the trinitrotrichlorobenzene (TCTNB) produced by the nitration is then aminated to yield TATB. The preferred manufacturing method to produce a particle size greater than 20 microns in 96 percent of the yield, suitable for PBXs and normal explosive compounds, is by the partially patented procedure that follows. The procedure is carried out in two steps; a nitration step and an amination.

(a) The equipment required is:

1 A 38 liter (10-gallon), glass-lined Pfaudler reactor capable of operation over a range of 200 to 150°C and pressure of 70 torr to 670 kilopascals (100 pounds per square inch), gauge, agitation provided by an anchor type blade at speeds of 20 to 200 revolutions per minute.

2 A glass-lined, concentric tube reflux condenser integral with the reactor.

3 A 189 liter (50-gallon), stainless steel reactor with agitator used in ice quenching of the nitration mixture.

4 Two 227 liter (60-gallon), stainless receivers used in filtrate storage and recovery.

5 A stainless steel, 28 centimeterx28 centimeterx5 centimeter plate and frame filter press, closed delivery washing type.

(b) The materials required for the nitration step are 2.5 kilograms of TCB with a melting point of 63°C to 64°C, 7.7 kilograms of NaNO₃ granular AR sodium nitrate, and 57.2 kilograms of 30 percent oleum. The oleum is charged to the glass-lined reactor, and the sodium nitrate is then added at a slow rate with full agitation. The reaction is quite exothermic, and jacket cooling is used to keep the temperature at 60° to 70°C. When the entire amount of sodium nitrate has been added and the exotherm peak has passed, the kettle contents are brought to a temperature of 100°C. The TCB is then charged to the reactor and steam is applied to the jacket to bring the temperature quickly to 145° to 155°C. The reactor contents are maintained at this temperature for a period of four hours. The small amounts of gas that are produced during the nitration are vented through the reflux condenser. At the end of the four hour reaction period, the contents are cooled to 40°C and discharged into the 50 gallon stainless steel reactor which contains approximately 113 kilograms of crushed ice. Full agitation is used during this quench step and the nitrous fumes are removed using a water sealed vacuum pump. The TCTNB product precipitates in the form of heavy, white crystals. With the stated quantity of ice, the temperature during dilution does not

exceed 40°C, and hydrolysis of the product does not occur. The quenched reaction mixture is then pumped through the plate and frame press which discharges into a 60 gallon holding tank. Dynel cloth is used as the filtering medium. Only two frames are needed for the amount of cake produced. The cake is washed with several 20 gallon quantities of water, each followed with an air blow. This is continued until the wash water pH is 6 to 7. The cake is dried in open trays in a forced draft oven at 60°C for 16 hours. This completes the nitration step.

(c) The materials required for the amination step are 2724 grams of the TCTNB produced during the nitration step, 27.24 kilograms of technical grade toluene, 681 grams of water, 1044 grams of refrigeration grade anhydrous ammonia. The quantity of ammonia includes the amount for leakage and blow down. The TATB yield will be two kilograms. First, the TCTNB is dissolved in the toluene and the solution is clarified by filtration using Celite filter aid before transfer to the 10 gallon reactor. At this point 67 percent of the contaminating ammonium chloride by-product can be eliminated by adding 681 grams of water. The reactor system is then sealed and heating is continued until the contents are at 145°C. Since the amination step is moderately exothermic, the jacket steam is turned off at this time. Ammonia gas is then added to the reactor gas phase through an opening on the top of the kettle. The ammonia is metered through a rotameter at a rate of about 3632 grams per hour. When the ammonia overpressure reaches about 34.5 kilopascals (five pounds per square inch), the reactor system is purged of residual air by venting through the reflux condenser. The system is then resealed and the reaction is continued for approximately three hours. Moderate agitation is used during this period. During most of the three hour reaction period, conducted at 150°C, the pressure is maintained at 241.3 to 275.8 kilopascals (35 to 40 pounds per square inch, gauge). This represents an ammonia partial pressure of about 34.5 to 69 kilopascals (5 to 10 pounds per square inch). As the reaction progresses, a small amount of jacket heating may be necessary to maintain the 150°C temperature. The termination of the amination reaction is marked by a sharp rise in system pressure to about 413.7 kilopascals (60 pounds per square inch, gauge). After the pressure rise, the ammonia flow is shut off and the system is cooled to about 60°C. The system is then vented and approximately ten gallons of water is added to the reaction mixture with good agitation. The TATB product is recovered by filtration using the plate and frame press equipped with cotton cloths backed with filter paper. One frame is sufficient for the amount of product pro

duced. The cake is washed three times with 20 gallon portions of water, interspersed with air blows. This is sufficient to remove by-product NH₄Cl. To-dry the cake and remove volatile impurities, the cake is steamed for about ten minutes and air-blown before removal from the press. The cake is then dried in open trays in a forced draft oven at 100°C for 16 hours.

(d) The yield of this process is 89.0 percent of the theoretical with 4 percent of the particles below 20 microns in size. The crystal density of the product is 1.93 grams per cubic centimeter. If water was added during the amination process to remove the ammonium chloride contaminate the amount of chlorine impurities will be about 0.2 percent. If no water was added, the chlorine impurities will amount to about 0.6 percent. The process used for the manufacture of finely divided TATB suitable for use in booster pellets is slightly different. Using this process 82±.5 percent of the product will pass through a 20 micron sieve. In this process all the amination reactions are conducted in a 100 gallon stainless steel reactor heated with 517.125 kilopascals (75 pounds per square inch) steam to the jacket. The reactor is fitted with an ammonia inlet, a vent tube for azeotroping water from the system, and a thermowell. The TCTNB is first dissolved in toluene in a feed vessel and passed through a 1.5 micrometer in-line filter during transfer to the reactor. The solution is then heated to 140°C and the water azeotroped from the system. The ullage is then backfilled with ammonia and

the temperature brought to 150°C. The reaction time varies between six and eight hours with completion indicated by a drop in ammonia flow as measured by the mass flow meter, an increase in system pressure approaching the 413.7 kilopascals (60 pounds per square inch, gauge) of the ammonia regulator and a decrease in the heat generated as indicated by the requirement of more steam to the reactor jacket. Product isolation involves cooling the reaction mixture to about 100°C, adding 40 liters of water, and vigorously stirring for half an hour. The warm mixture is isolated in a plate and frame press, washed with 85°C water for one hour, and steamed for one hour. The product is then dried for a minimum of 16 hours at a temperature of 115°C prior to sampling and packaging.

(3) TATB has an impact sensitivity of 11 inches by the Picatinny Arsenal apparatus for a seven milligram sample. By the ERL apparatus using a 2.5 kilogram weight with type 12 tools and without grit, the no detonation or reaction height is 200 centimeters. The point of 50 percent detonations is approximately 800 centimeters; the weight energy at this point is about 200 joules. The shock input to cause detonation has been determined to be 9500 joules per square meter. The five second explosion temperature test result is 520°C, and the auto ignition point is 320°C to 325°C. A charge of 0.30 grams of lead azide is required to initiate TATB. Table 8-43 lists the gap test results for TATB. Susan test results are shown in figure 8-52.

Table 8-43. Small Scale Gap Test Results for TATB

	Density grams per cubic centimeter	Percent voids	Sensitivity in millimeters
NSWC small scale gap test	1.887	2.2	1.12
	1.519	21.3	4.12
LANL small scale gap test	1.872 (pressed)	3.4	0.13
LANL large scale gap test	1.786 (pressed)	2.8	41.68
	1.705 (pressed)	7.2	45.36
	0.81 (bulk)	56	49.3
PX gap test	1.883 (pressed)	-	approximately 5.3
	1.861 (pressed)	4.0	5.61
	1.700 (pressed)	12.3	14.10
	1.03 (bulk)	-	10.2 - 16.3

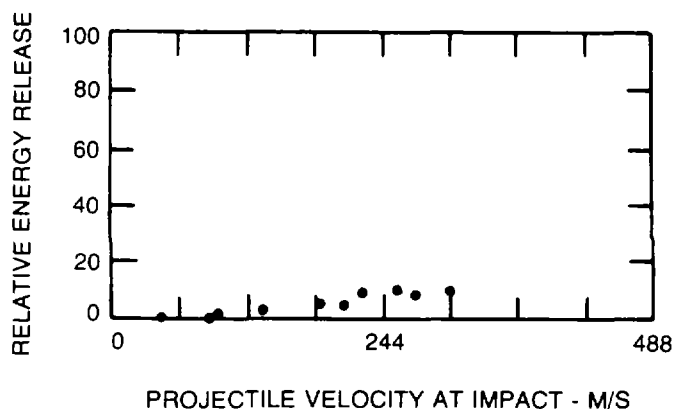

Figure 8-52. Susan test results for TATB.

(4) In the sand test, TATB crushes 42.9 grams of sand indicating a brisance of 90 percent of TNT. The detonation velocity as a function of density is given by the equation:

$$D = 2.480 + 2.85p$$

where D is in kilometers per second and p, the density, is in grams per cubic centimeter. This equation yields slightly higher results than reported by other investigators. The detonation pressure for a sample with a density of 1.847 grams per cubic centimeter is 259 kilobars. Table 8-44 lists, as a function of density, the Chapman-Jouguet pressure, energy, and isentropic exponent from watershock measurements.

Table 8-44. Detonation Characteristics of TATB

Density in grams per cubic centimeter	Detonation velocity in meters per second	UH20 in detonation meters per second	mH ₂ O meters per second	Pressure at explosive water interface in kilobars	Detonation pressure in kilobars	Isentropic exponent	Detonation energy in calories per gram
1.80	7,658	6,071	2,685	163.0	259.4	3.07	829
1.50	6,555	5,519	2,303	126.9	174.6	2.71	808

The Chapman-Jouguet pressure at crystal density is calculated to be 313 kilobars. Under oxygen deficient conditions the formation of detonation product gases proceeds according to the equation:

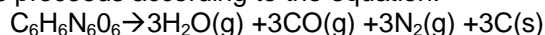

(5) TATB has excellent thermal stability. Differential Scanning Calorimeter measurements show exotherms at 330°C and 350°C when run at a heating rate of 10°C per minute. In the 1000 heat test, approximately .17 cubic centimeters of gas are evolved in 48 hours. In the 200°C test for 48 hours 0.5 cubic centimeters of gas are evolved; at 220°C for 48 hours 2.3 cubic centimeters are evolved. At 260°C for one hour approximately 1.2 cubic centimeters of gas are evolved. At 280°C 2.0 cubic centimeters of gas are evolved. Figure 8-53 shows the DTA curve for TATB.

f. 2,4,6-Trinitrotoluene (TNT).

(1) This explosive is also known as trotyl, tolit, triton, tritol, trilite, and 1-methyl-2,4,6-trinitrobenzene. TNT has been the most widely used military explosive from World War I to the present time. The advantages of TNT include low cost, safety in handling, fairly high explosive power, good chemical and thermal stability, favorable physical properties, compatibility with other explosives, a low melting point favorable for melt casting operations, and moderate toxicity. There are six possible ring nitrated TNT

isomers. The alpha isomer, which is the one of military interest (figure 8-54) is symmetrical and will be referred to as TNT. The other five meta isomers will be identified by the Greek letters beta through eta excluding zeta. TNT is a yellow, crystalline compound with a nitrogen content of 18.5 percent, an oxygen balance to CO₂ of -73.9 percent, a molecular weight of 227.13, and a melting point of 80°C to 81°C. The freezing point, which is a more reproduceable quantity than the melting point, is used in the specification for the two military types of TNT that are procured. The freezing point is very sensitive to impurities. At atmospheric pressure, TNT boils at 345°C. Small amounts can be distilled rapidly at atmospheric pressure without an explosion, but explosions do occur with the longer heating periods required for larger quantities. TNT boils at 190°C, 210°C to 212°C, and 245°C to 250°C at 2 torr, 10 to 12 torr, and 50 torr, respectively. Unlike some other high explosives TNT does not undergo partial decomposition when melted. Samples of TNT have been melted and solidified at least 60 times with no significant decrease in the freezing point. The effect of moisture content on the freezing point is shown in table 8-45.

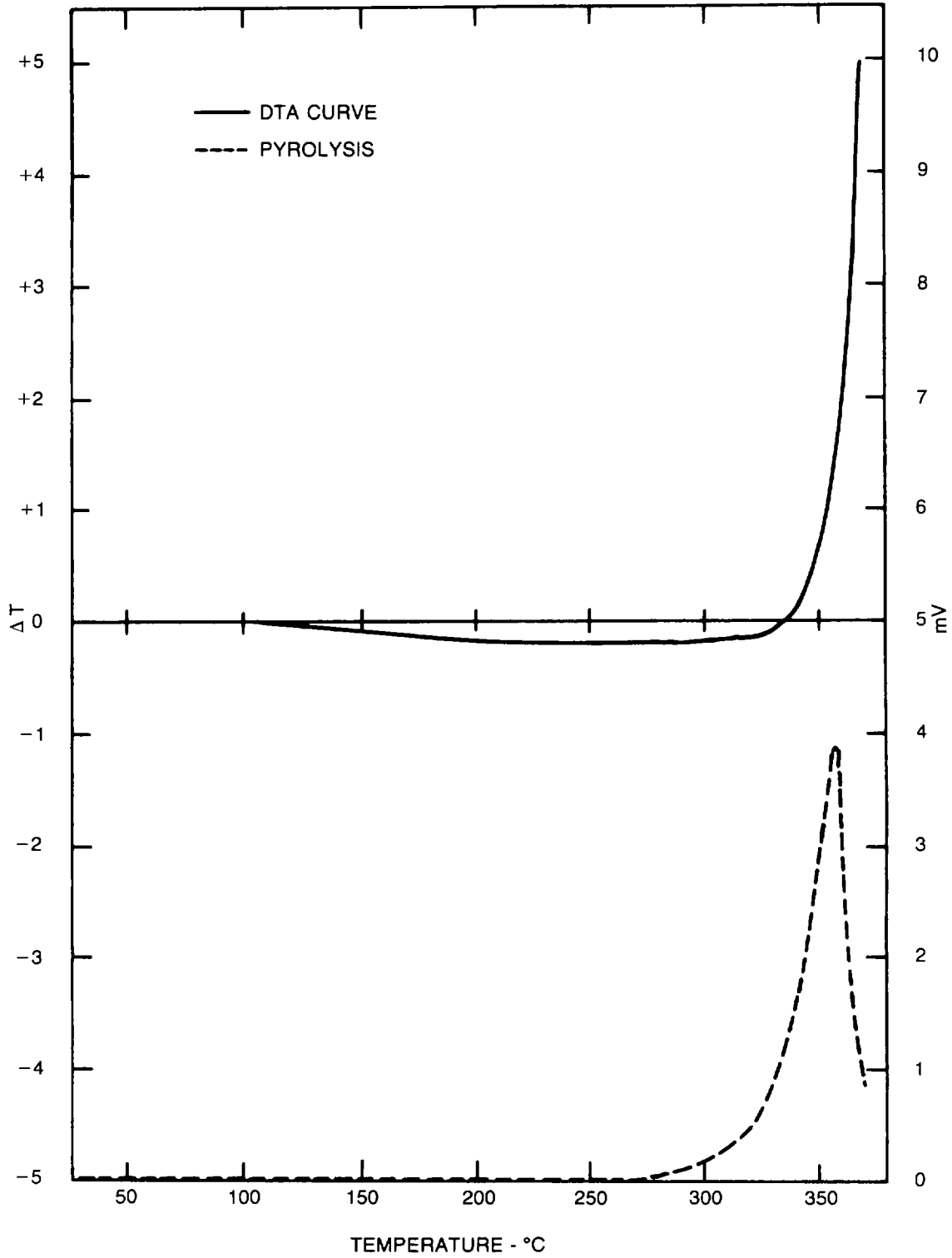

Figure 8-53. DTA curve for TATB.

Table 8-45. Effect of Moisture on the Freezing Point of TNT

Percentage of water	Freezing point in °C
0	80.59
0.1	80.35
0.2	80.20
0.3	79.99
0.5	79.78
1.0	79.09
2.5	77.93

Removal of moisture from a sample of TNT by heating at 100°C is slow as shown in table 8-46. The sample started with a water content of 0.3 percent.

Table 8-46. Removal of Moisture from TNT

Hours of heating at 100°C	Freezing point of sample in °C
0	79.99
2	80.30
3.5	80.46
5	80.55
6	80.59

At ordinary temperatures TNT is essentially nonvolatile. TNT has a crystal density of 1.654 grams per cubic centimeter, a cast density of 1.5 to 1.6 grams per cubic centimeter and a maximum pressed density of 1.63 to 1.64 grams per cubic centimeter. Table 8-47 shows the density of TNT as a function of loading pressure although densities as high as 1.64 grams per cubic centimeter have been reported.

Table 8-47. Density as a Function of Loading Pressure for TNT

Pressure in kilopascals	Pressure in pounds per square inch	Density in grams per cubic centimeter
20,685	3,000	1.34
34,475	5,000	1.40
68,950	10,000	1.47
82,740	12,000	1.49
103,425	15,000	1.52
137,900	20,000	1.55

The density of the liquid in the temperature range of 83°C to 120°C is given as a function of temperature by the equation:

$$D=1.5446-1.016 \times 10^{-3}t$$

where D, the density, is in grams per cubic centimeter and t is in degrees centigrade. Several crystalline structures of TNT are known. Samples of TNT obtained by sublimation onto a condensing surface held at a temperature, 78°C, very close to the melting point consist solely of the simple monoclinic form. Freezing the melts at a temperature very close to the melting point also yields a monoclinic form. Crystallization from solvents at room temperature or from strongly supercooled melts yield primarily monoclinic variant forms. Orthorhombic TNT is formed by crystallization from solvents at low temperatures. The unit cell dimensions of the monoclinic form are a=21.275 Angstroms, b=6.093 Angstroms, and c=15.025 Angstroms with eight molecules per unit cell. The unit cell dimensions of the orthorhombic form are a=15.007 Angstroms, b=20.029 Angstroms, and c=6.098 Angstroms. At least seven morphological types of TNT have been identified. Unusual crystal growth has been observed when TNT crystals are held near the melting point. Additives have a great effect on the crystallization process. Picryl chloride induces the formation of the orthorhombic form. Other picryl derivatives, especially 2,4,6-trinitrostilbene, drastically reduce the linear crystallization rate. Two compounds, hexanitrobiphenyl (HNBB) and methylpentanitrodiphenylmethane (MPDM), which are introduced during the purification phase of manufacture, have the same effect. These compounds have adverse effects on melt loading operations. During the melt loading operation cracks and voids tend to form in the cast material. The cracks are caused by an 11 percent shrinkage in the volume of the TNT upon solidification. The voids appear between the grains of the large orthorhombic crystals which are formed. A method to preclude the cracks and voids involves a procedure for overcoming the strong tendency of molten TNT to supercool with subsequent slow initial crystallization at the melt surface resulting from an insufficiency of crystal nuclei. Addition of solid seed TNT crystals to the melt while stirring yields a smooth casting with the desired very fine, randomly-oriented, monoclinic crystals. TNT prepared in this fashion undergoes irreversible crystal growth upon thermal cycling if the maximum temperature is above about 30°C to 35°C. For temperatures above 35°C a linear relationship exists between the growth with a corresponding decrease in density and the maximum temperature attained in the cycle. The growth correlates with the quantity of impurities present. However, the high viscosity of the mixture and the fine temperature control required, make this procedure impractical. Another procedure involves the addition of less than 2 percent HNS. The crystals formed are largely monoclinic and the casts are of sufficient quality. This method is a promising procedure, however TNT

surveillance test samples containing 0.5 percent HNS submitted to thermal cycling showed increased exudation, irreversible crystal growth, decreasing density, and, eventually, complete crumbling.

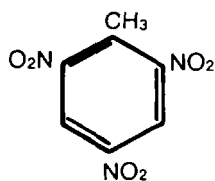

Figure 8-54. Structural formula for TNT.

(2) The viscosity of liquid TNT is 0.139 and 0.095 poise at 85°C and 100°C, respectively. The refractive index values are alpha = 1.543, beta = 1.674, and gamma = 1.717. These values indicate a hardness of 1.4 on the Mohs scale. The observed molecular refraction is 49.6. The surface tension of liquid TNT as a function of temperature is shown in table 8-48.

Table 8-48. Surface Tension of Liquid TNT

Temperature in °C	Surface tension in dynes per centimeter
80	47.07
85	46.63
87.6	46.36
90	46.04
95	45.62

Cast TNT with a density of 1.62 grams per cubic centimeter has a compressive strength of 9,515 to 9,653 kilopascals (1,380 to 1,400 pounds per square inch). The dielectric constant, measured at 35 giga hertz, is shown in table 8-49 for crystal and flaked TNT.

Table 8-49. Dielectric Constant of TNT

Density in grams per cubic centimeter	Dielectric constant, crystals	Dielectric constant, ground flakes
0.9	2.048	2.092
1.2	2.347	2.362
1.5	2.795	2.773
1.7	3.178	3.125

The solubility of TNT in various solvents is shown in table 8-50. Over the range of 82°C to 95°C, molten TNT absorbs 3.22 milliliters of air per 100 grams of TNT. The approximate specific heat of TNT in calories per gram per degree centigrade is given by the equations:

$$0.254 + (7.5 \times 10^{-4}) T \quad T < 80.5^\circ\text{C}$$

$$0.329 + (5.5 \times 10^{-4}) T \quad T > 80.5^\circ\text{C}$$

Additional information concerning the specific heat, entropy, and enthalpy of TNT is available in table 8-51. Please note the difference in units from the above data.

Table 8-50. Solubility of TNT

	Solubility in grams per 100 grams of solvent at °C							
	0	20	25	30	40	50	60	75
Ethanol (95%)	0.65	1.23	1.48	1.80	-	4.61	-	19.5
Ether	1.73	3.29	3.80	4.56	-	-	-	-
Acetone	57	109	132	156	-	346	-	-
Carbon tetrachloride	0.20	0.65	0.82	1.01	-	3.23	-	24.35
Chloroform	6	19	25	32.5	-	150	-	-
Ethylene chloride	-	18.7	22	29	-	97	-	-
Benzene	13	67	88	113	-	284	-	-
Toluene	28	55	67	84	-	208	-	-
Carbon disulfide	0.14	0.48	0.63	0.85	-	-	-	-
Methyl acetate	-	72.1	80	99	-	260	-	-
Triacetin	-	-	37.7	-	-	-	-	-
Butyl carbitol acetate	-	24	-	-	-	-	-	-
Sulfuric acid	-	4	-	-	-	-	-	-
N,N-dimethylformamide	90	119 at 150C	142	-	-	-	-	-
Dimethyl sulfoxide	-	-	128	-	-	-	-	-
1-Methyl-2-pyrrolidinone	-	-	118	-	-	-	-	-
Pyridine	-	137	-	-	-	-	-	-

Table 8-50. Solubility of TNT (Cont)

	Solubility in grams per 100 grams of solvent at °C							
	0	20	25	30	40	50	60	75
Chlorobenzene	-	33.9	-	-	-	-	-	-
1,2 Dichloroethane	-	18.7	-	-	-	-	-	-
Diethyl ether	-	3.29	-	-	-	-	-	-
Trichloroethylene	-	3.04	-	-	-	-	-	-
Methanol	-	-	-	-	9.5	-	31.6	-

Table 8-51. Specific Heat, Enthalpy, and Entropy of TNT

Temperature in °K	Specific heat in joules per mole per °K	Enthalpy in joules per mole	Entropy in joules per mole per °K
10	3.116	10.390	1.732
30	32.71	352.77	17.49
50	60.41	1293.0	40.90
70	82.52	2731.0	64.89
90	101.70	4576.7	87.98
110	118.76	6784.8	110.08
130	133.54	9309.6	131.13
150	148.30	12128	151.28
170	162.84	15240	170.73
190	177.15	18640	189.63
210	191.24	22325	208.05
230	205.09	26288	226.07
250	218.72	30527	243.74
270	232.12	35036	261.08
300	251.80	42296	286.56

Values for the heat of combustion for the crystal range from 809.18 to 817.2 kilocalories per mole. The heat of formation for the liquid or crystal is between 10 and 19.99 kilocalories per mole. The free energy of formation for the crystal is 50.92±0.83. The heat of fusion computed by interpolation of enthalpy curve is 23.53 calories per gram although values from 20.2 to 25.2 have been reported. Values for the heat of sublimation range from 23.2 to 33.7 kilocalories per mole. The Gibbs free energy of sublimation is 69.6±3.0 kilojoules per mole and the standard entropy of sublimation is 146.2±1.3 joules per mole per degree Kelvin. The heat of vaporization is reported in the range of 17 to 22.7 kilocalories per mole. The maximum calculated heat of detonation with liquid water is 1.41 kilocalories per gram; with gaseous water the value is 1.29 kilocalories per gram. For a charge with a density of 1.54 grams per cubic centimeter, the measured values are 1.09 kilocalories per gram with liquid water and 1.02 kilocalories per gram with gaseous water. The enthalpy of TNT relative to the enthalpy at 0°C for the range 25°C to 68°C is expressed by the equation:

$$H - H_0 = 0.045 + 0.24625 T + (4.205 \times 10^{-4}) T^2$$

where T, the temperature, is in units of degrees centigrade. For the range 83°C to 117°C the relative enthalpy is expressed by the following equation:

$$H - H_0 = 12.450 + 0.45023 T - (4.0091 \times 10^{-4}) T^2$$

In this equation T is also in units of degrees centigrade. The standard enthalpy is 113.2 ±1.5 kilojoules per mole. The standard entropy for the crystal is 68.12±0.38 calories per degree Kelvin per mole. Thermal diffusivity as a function of temperature is shown in table 8-52.

Table 8-52. Thermal Diffusivity of TNT

Thermal diffusivity in centimeters squared per second x 10 ⁴ at 25°C	Density in grams per cubic centimeter
19.7	0.64
15.0	0.783
12.1	0.980

TNT forms binary and ternary eutectics with various types of nitro compounds and nitrate esters. The dinitrotoluenes and the unsymmetrical TNT isomers form

eutectics with 2,4,6-TNT which melt just above room temperature. Removal of these impurities is necessary to prevent exudation from TNT based explosives. TNT is used as a shell filler and as an ingredient in many composition explosives. Dinitrotoluene is also used in the filling of shells.

(3) The following sections of this subparagraph deal with the chemical reactivity of TNT. The sections are divided first by the structure of the TNT molecule involved in the reaction, such as the methyl group, the nitro group, and the aromatic ring. Then the reactions are further subdivided by the type of reaction.

(a) Reactions of the methyl group.

1 The methyl group can be halogenated. Monochlorination can be affected with sodium hypochlorite according to the following equation.

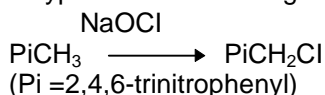

The chloride, prepared in situ, is important as the intermediate for preparing 2,2',4,4',6,6'-hexanitrostilbene according to the reaction:

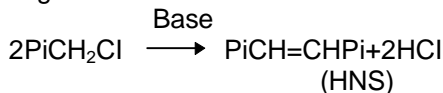

HNS is a thermally-stable explosive and a nucleant for improving the crystallization habit of TNT in explosive formulations such as composition B. In the presence of excess TNT, the chloride yields 2,2',4,4',6,6'-hexanitrobibenzyl (HNBB) which can be oxidized to HNS according to the equation:

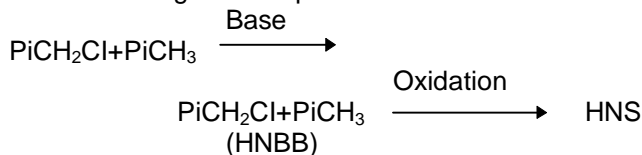

Destructive chlorination to chlorpicrin (Cl₃CNO₂) has been noted on warming TNT with Ca hypochlorite. Small amounts of chlorpicrin are formed during the preparation of HNS from TNT and sodium hypochlorite. On a production scale, an environmental problem is created since this compound is a toxic lachrymator. Heating TNT under pressure at 150°C to 160°C with phosphorus pentachloride and a trace of iodine is said to give a mixture of products including mainly 2,4,6-trinitrobenzotrithloride and pentachlorobenzyl chloride. Others, however, were unable to prepare the former compound in this way. TNT can be monobrominated with sodium hypobromite, or less conveniently by heating under pressure at 160°C with bromine and magnesium carbonate. Heating TNT with bromine and a trace of iodine under pressure at 200°C gives pentabromobenzyl bromide according to the equation:

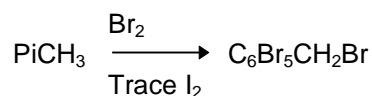

2 The methyl group can be oxidized. The oxidation can proceed stepwise through the alcohol and aldehyde to the acid, as follows:

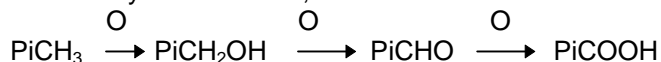

Trinitrobenzoic acid can be prepared by this procedure. The alcohol and aldehyde are more easily oxidized than the TNT so the oxidization cannot be stopped at either of these stages. Other reactions must be used to prepare these products. Trinitrobenzoic acid is easily and quantitatively converted to 1,3,5-trinitrobenzene (TNB), an explosive superior to TNT in many ways, but more expensive to make. Oxidation of TNT is the preferred procedure for preparing TNB. This can be done in 85 percent yield by heating TNT with 90 percent nitric acid at 150°C under pressure for 18 hours, but the preferred laboratory procedure involves oxidation with potassium or sodium dichromate in concentrated sulfuric acid. Yields in this procedure vary from 43 to 46 percent to 86 to 90 percent, apparently depending on minor variations in technique. The addition of acetic acid as cosolvent is said to give a 98 percent yield of the acid. Oxidation of the methyl group occurs during TNT manufacture with 2 to 4 percent of yield loss occurring in this way. Under certain conditions the alcohol, as a nitrate, and the aldehyde are formed by the oxidation. The two compounds then react to form 2,2'-dicarboxy-3,3',5,5'-tetranitroazoxybenzene as shown in figure 8-55. This compound, called white compound, coats the equipment piping and must be cleaned off. By a suitable variation in conditions, this reaction can be minimized, with the alcohol and aldehyde being oxidized preferentially to the acid. Crude TNT contains small amounts of each trinitrobenzyl alcohol and trinitrobenzaldehyde are formed by side reactions during the preparation of HNS from TNT using sodium hypochlorite. The two compounds also appear in small amounts during the action of heat or light on TNT. TNT can be oxidized to HNBB, in poor yield, by simply adding base to a solution of TNT in a suitable solvent according to the reaction:

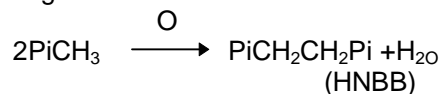

The nitro groups in a portion of the TNT are the oxidizing agent. Small amounts of HNBB are formed by this reaction during the purification of TNT with alkaline sodium sulfite. Air oxidation in the presence of base and copper sulfate is claimed to give yields as high as 82 percent.

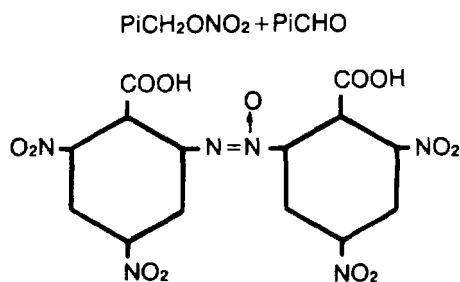
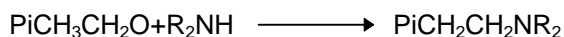

Figure 8-55. White compound.

3 The methyl group can react with aldehydes. Formaldehyde reacts with TNT as follows:



The reaction can be carried out by heating TNT in a basic solution of aqueous formaldehyde. TNT is only poorly soluble in this solution, however. Better results are obtained when acetone is used as a cosolvent. TNT undergoes the Mannich reaction with formaldehyde and various secondary amines according to the equation:



In this reaction dioxane was used as solvent and 2 percent sodium hydroxide was added as catalyst; piperazine forms a 1:2 derivative. Benzaldehyde reacts with TNT to form two compounds. The molar ratio between the reactants in one of the compounds is one to one. The reaction proceeds according to the equation:

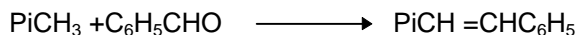

The reaction is catalyzed by piperidine and is run in an aromatic solvent such as benzene or toluene. A series of monosubstituted benzaldehydes react similarly as do also terephthalaldehyde and isophthalaldehyde. One mole of both of the last two reactants combines with two moles of TNT. In the second compound benzaldehyde forms with TNT, one mole of benzaldehyde reacts with two moles of TNT. The reaction proceeds according to the equation:

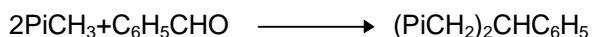

This reaction is also catalyzed by piperidine but is run in pyridine. Only traces of HNS were obtained from TNT and 2,4,6-trinitrobenzaldehyde.

4 The methyl group reacts with halides and unsymmetrical TNT isomers. In the presence of equivalent potassium hydroxide, TNT reacts as follows with various halides such as 4-nitrobenzyl bromide, picryl chloride, or 2,4-dinitrofluorobenzene:

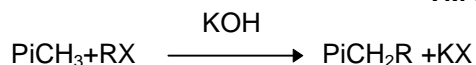

Only compounds with highly reactive halogens yield products by this reaction. As the halide reactivity decreases, increasing amounts of HNBB are formed from TNT in the presence of a base. This type of reaction can also occur with compounds containing reactive nitro groups. In the manufacture of TNT, 2,4,6- and 2,4,5- TNT interact in this manner to form MPDM, as shown in figure 8-56. A similar compound can be made from 2,4,6-TNT and 2,3,4-TNT.

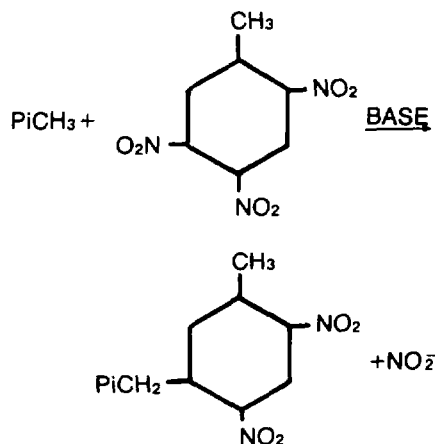
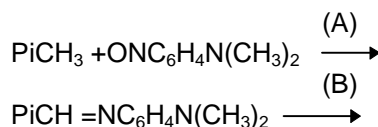

Figure 8-56. TNT and 2,4,5-TNT reaction.

5 The methyl group reacts with various nitroso compounds. The reaction with 4-nitrosodimethylaniline, reaction (A), and subsequent hydrolysis, reaction (B), to yield 2,4,6-trinitrobenzaldehyde, PiCHO , is shown below:



This is the favored procedure for preparing 2,4,6-trinitrobenzaldehyde. Reaction (A) is run at room temperature in pyridine, using iodine as a catalyst, or in a alcohol-acetone mixture with anhydrous sodium carbonate as a catalyst. Reaction (B) proceeds in a strong aqueous hydrochloric acid solution; overall yields are 39 to 52 percent. Reaction (A) can be run in an aqueous medium in the presence of light with a yield of 80 percent and less by-product formation than in the other methods. Other types of aromatic nitroso compounds, for example nitrosobenzene and nitrosotoluene, form nitrones according to the equation:



where X depends on the specific reaction.

6 The methyl group can undergo nitration and nitrosodation. The reaction with alkaline fluorotrinitromethane proceeds according to the equation:

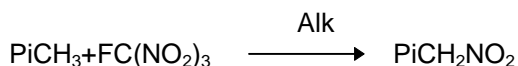

Several products are formed with nitrosylchloride, as shown in figure 8-57.

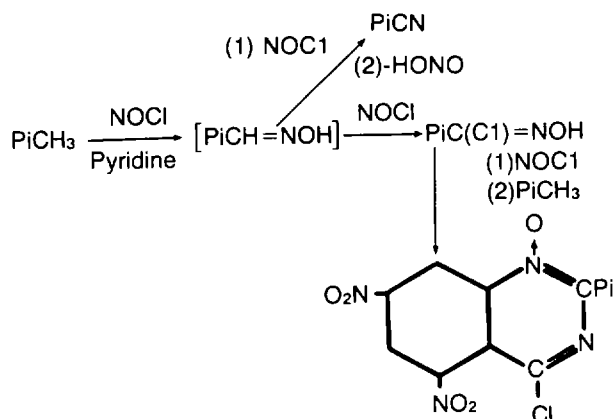
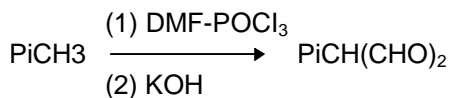

Figure 8-57. Reaction of TNT with nitrosylchloride.

7 Other miscellaneous reactions of the methyl group include the reaction with N,N-dimethylformamide and phosphorus oxychloride in which TNT undergoes the Vilsmeier reaction as shown below:



The resulting dialdehyde was converted to derivatives. The reaction between phthalic anhydride and TNT is reported to form a phthalide derivative as shown in figure 8-58. However the reaction could not be duplicated. When TNT couples with diazonium compounds, the most likely reaction is:

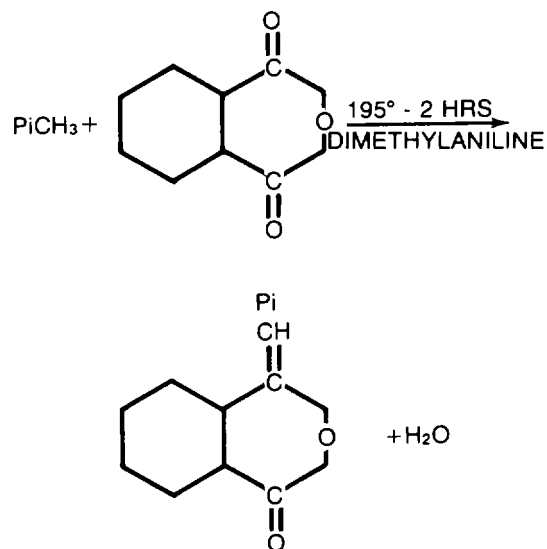
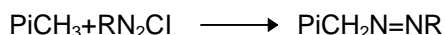

Figure 8-58. Reaction between TNT and phthalic anhydride.

(b) Reactions of the aromatic ring.

1 TNT can be monomethylated to trinitro-m-xylene in 9 to 32 percent yield by heating with lead tetracetate or acetyl peroxide, or by electrolysis with acetic acid-sodium acetate. Attempts to introduce more methyl groups have been unsuccessful.

2 Reduction of TNT with sodium borohydride gives 1-methyl-2,4,6-trinitrocyclohexane in 21 percent yield according to the reaction shown in figure 8-59.

3 One mole of TNT reacts with three moles of diazomethane. The compound obtained from diazomethane and 1,3,5-trinitrobenzene has the seven member ring shown in figure 8-60.

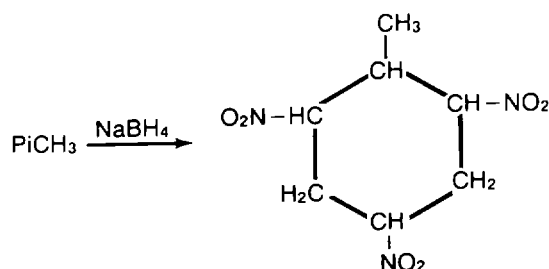

Figure 8-59. Reduction of TNT with sodium borohydride.

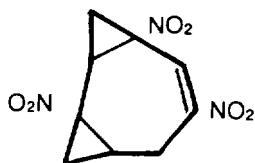

Figure 8-60. Seven member ring structure.

4 TNT undergoes methyl group halogenation as well as ring halogenation with loss of the nitro groups at 150°C to 200°C.

5 Ring cleavage to chloropicrin occurs with alkaline hypochlorites. TNT can also be destroyed by treatment with ozone, in the presence of base, or ultraviolet light. In both cases, the 2,4,6-trinitrobenzyl anion is generated, which is presumably the reactive species.

(c) Reactions of the nitro groups.

1 TNT can be reduced to the triamino compound with tin and hydrochloric acid, or with hydrogen using a Pd-BaSO₄ catalyst as shown in figure 8-61.

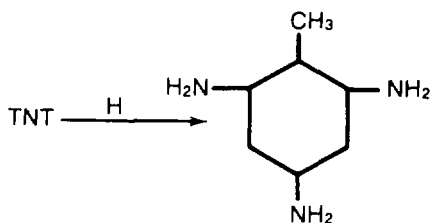

Figure 8-61. Reaction of TNT with hydrogen.

2 4-Amino-2,6-dinitrotoluene can be made by treating TNT in dioxane with ammonium

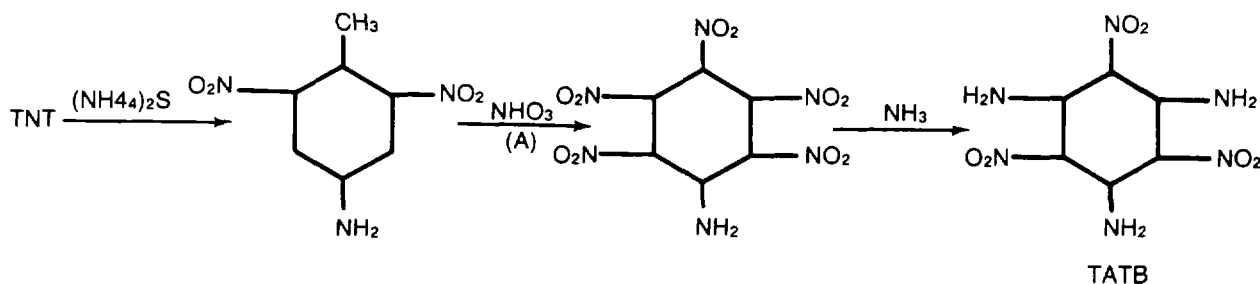

Figure 8-62. Production of TATB from TNT.

sulfide. A 37 percent yield of material of 99 percent purity was so obtained.

3 Reduction of TNT with ethanolic ammonium sulfide yields 2,4-diamino-6-nitrotoluene. Reaction of TNT with ethyl alcoholic hydrogen sulfide containing a small quantity of ammonia gives a mixture comprising 22 percent unreacted TNT, 22 percent 4-amino-2,6-dinitrotoluene, 4 percent 2-amino-4,6-dinitrotoluene, 44 percent 4-hydroxylamino-2,6-dinitrotoluene, and 8 percent 2-hydroxylamino-4,6-dinitrotoluene. The 4-hydroxylamino compound can be extracted from the reaction mixture. The 4-amino-2,6-dinitrotoluene is an intermediate for one procedure for preparing the thermally-stable, insensitive explosive TATB. The reaction is shown in figure 8-62. Reaction (A) involves an unusual demethylation as well as nitration. The above partial reduction products of TNT, among others, are formed during biodegradation and during the destruction of TNT by reaction with sodium or ammonium sulfide. TNT does not undergo hydrolysis during storage of a saturated solution in sea water over a period of several months at 25°C in active glassware.

(d) Some reactions involve both the nitro and methyl group. An important aspect of TNT reactivity involves redox reactions between the reactive methyl group and the nitro groups, a type of reaction which can be initiated by various energetic stimuli including thermal and photochemical as well as chemical. The following discussion indicates the reactions are both intra- and intermolecular, ultimately leading to diverse monomeric and polymeric products. The intramolecular type involves reaction between the methyl group and an ortho nitro group. This reaction occurs especially easily and is often the first step for other reactions. The reaction also applies to many other derivatives and analogues of 2-nitrotoluene.

1 All types of nitro compounds react easily with bases forming diverse types of products. In the case of TNT, 2,4,6-trinitrobenzyl anion (I) is formed initially and rapidly as shown in figure 8-63. The ion is a highly reactive species thought to be intermediate in the many reactions of TNT conducted under basic conditions. The anion is formed without side reactions by the action of 1,1',3,3'-tetramethylguanidine in dimethylformamide solvent. Based on spectrophotometric evidence, the first dissociation constant of TNT with NaOH is $1.02 \pm 0.2 \times 10^{-12}$. Highly-colored Jackson-Meisenheimer, or sigma, complexes of structure (II) or (III), also shown in figure 8-63, are formed by addition to the ring system. These compounds are formed in both aqueous and anhydrous mediums and with a variety of organic and inorganic nucleophiles. Sulfite ion forms a complex of structure (III) which is a source of yield loss during the purification of TNT if the pH exceeds eight. Cyanide ion also forms a complex of structure (III). TNT as the anion (I) can react with other TNT anion (I)'s and produce adducts of structure (II). A similar reaction takes place with 1,3,5-trinitrobenzene. Primary and secondary aliphatic amines also form sigma complexes. Upon solution in liquid ammonia, a complex of type (III) is initially formed with no evidence of type (I) having been formed. With time, a second NH_2 group becomes attached to the ring carbon with the methyl group; this compound has cis- and trans-isomers. Removal of the ammonia

gives a red residue comprising about 50 percent TNT. Acetone carbanion forms a complex of structure (III). Methoxide, ethoxide, and isopropoxide form complexes of structure (II). T-butoxide ion yields structure (I) with TNT.

2 In some cases each mole of TNT can add up to three moles of a base. The compounds formed with potassium hydroxide in a dilute aqueous solution are shown in figure 8-64. The one to one molar ratio compound is the same type compound as structure (II) shown in figure 8-64. Three moles of potassium ethoxide can also react. Addition of two moles of sodium sulfite is also possible.

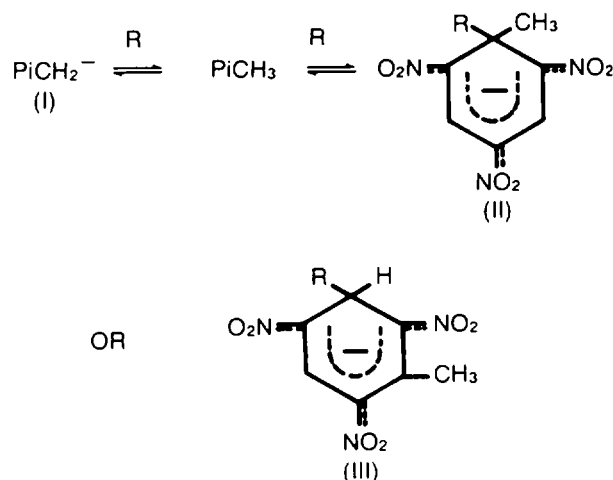

Figure 8-63. Reaction of TNT with bases.

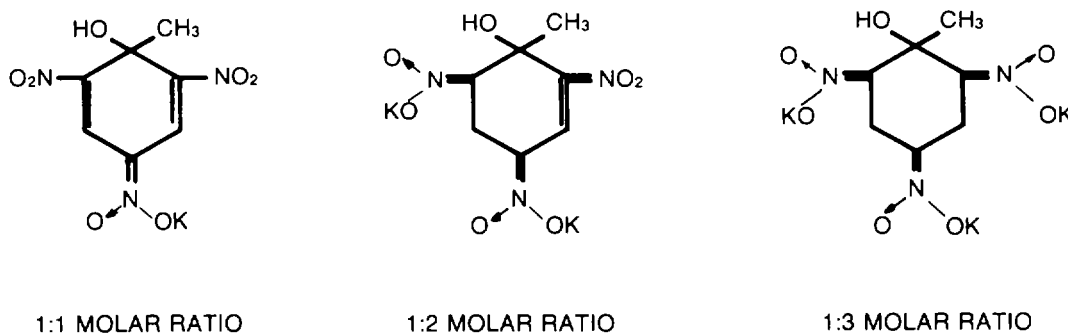

Figure 8-64. Reaction of TNT with potassium hydroxide.

3 Side reactions can occur, especially in the presence of excess base at elevated temperatures and prolonged times of reaction. Potassium hydroxide and anhydrous ammonia can form nitrite ions by cleavage of nitro groups. 2,4,5-Trinitrophenol and 3,5-dinitrophenol have been isolated from the reaction of TNT with NaOH. Redox reactions give polymeric materials via the formation of azo and azoxy groups, as shown in figure 8-65 for the case of phenylhydrazine. Dimerization also occurs by the redox coupling of two molecules of TNT to form $\text{PiCH}_2\text{CH}_2\text{Pi}$. The oxidant in this case is TNT. The complexes of long-chain, primary-secondary aliphatic amines with TNT have low water solubility and may be useful for the removal of TNT from aqueous solutions. The rapid reactions with isopropylamine in acetone has been studied as a possible procedure for the neutralization of TNT in land mines.

(e) The degradation of TNT by electron impact has been studied. The initial step is a methyl-hydrogen transfer to an adjacent nitro-oxygen which is followed by cleavage of the hydroxyl group. The resulting ion then degrades further by several routes which include the loss of small stable molecules such as CO, NO, $\text{HC}=\text{CH}$, HCN, etc. All of the TNT isomers undergo similar methyl-hydrogen transfer as the first

step except for the 3,4,5-isomer, which lacks the adjacent methyl and nitro groups.

(f) In the manufacturing process, absorption by activated carbon filters is commonly employed to control pollution. The TNT is absorbed at many of the numerous high-energy sites on the surface of the carbon. Basic materials, introduced during activation of the carbon by combustion and oxidation are also present at these sites, then induce oxidation-reduction reactions of the methyl with the nitro groups in the TNT. This is manifested in the simplest form by the formation of small amounts of trinitrobenzoic acid and trinitrobenzene. Coupling and polymerization also occur, via generation of azo and azoxy linkages among others, yielding complex, high molecular-weight materials which are irreversibly bound to the surface and clog the pores of the carbon. This process is, therefore, generally similar to that involved in the thermal and basic decomposition of TNT. When TNT and activated carbon are dry-mixed at room temperature, the TNT rapidly and completely displaces the air absorbed on the carbon. The carbon has a strong catalytic effect on the thermal decomposition of TNT. At 120°C , a 90/10 TNT/carbon mixture decomposes 12.3 times as fast as pure TNT, and a 50/50 mixture 113 times as fast.

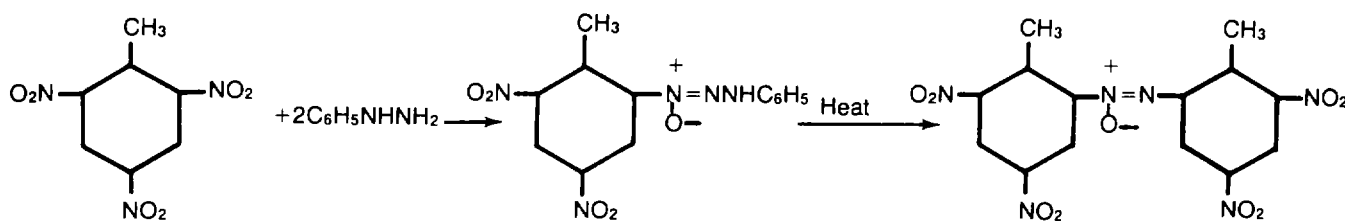

Figure 8-65. Reaction of TNT with phenylhydrazine.

(4) Of the six possible TNT isomers, five are unsymmetrical or meta isomers. Physical properties of the six are summarized in table 8-53.

Table 8-53. Isomers of TNT

Isomer	Melting point in °C	Position of reactive nitro group	Deflagration temperature in °C	
			Pure	With Na ₂ CO ₃
2,4,6 (alpha)	80.9	This is the symmetrical isomer so has none	281-300	
2,3,4 (beta)	110-111	3	301-303	208-215
2,4,5 (gamma)	104-104.5	5	288-293 290-310	191-198
3,4,5 (delta)	133-134	4	305-318	252
2,3,5 (epsilon)	96-97	2	333-337	268-271
2,3,6 (eta)	111.5-112.5	3	327-335	249-250

The unsymmetrical isomers all differ from the 2,4,6-isomer in having notably higher melting points and in having one nitro group which is easily replaced by treatment with various nucleophilic reagents; the position of this group is indicated in table 8-53. Consequently, the reactions of 2,4,6-TNT under basic conditions are entirely different from those of the other five isomers. All of the unsymmetrical isomers have been found in crude TNT, ranging from about 2.5 percent for the 2,4,5-isomer and 1.5 percent for the 2,3,4-isomer down to 0.006 percent for the 3,4,5-isomer. The meta isomers form low melting point eutectics with TNT and so must be removed during the manufacturing process.

(5) TNT is manufactured by the nitration of toluene in successive steps. In the first step toluene is nitrated to mononitrotoluene (MNT). The MNT is then nitrated to dinitrotoluene (DNT). The last step is the nitration of DNT to TNT. The three steps are carried out under different conditions. The trinitration is carried out at a higher temperature than the dinitration, which is carried out at a higher temperature than the mononitration. The trinitration also requires a stronger mixed acid than the dinitration, which requires a stronger mixed acid than the mononitration. In the continuous production system installed at Radford Army Ammunition Plant these requirements are met with a counter flow process. The system consists of eight nitrators. Toluene is introduced into nitrator number one and moves successively through each nitrator to nitrator number eight where nitration to TNT is completed. Mixed acid is introduced into nitrator number eight and moves successively through each nitrator to nitrator

number one. The mixed acid consists of nitric acid, 40 percent oleum, and water. Fortification with nitric acid is required between nitrators. The temperature of nitrator number one is maintained at 50°C to 55°C. Each successive nitrator is maintained at a higher temperature than the one immediately preceding. Nitrator number eight is maintained at about 100°C. Each nitrator is equipped with an agitator. The solubility of toluene and the nitrotoluenes in mixed acid is very low. Therefore, the nitration proceeds in a two phase system and the rate of nitration depends on dispersion. The dispersion depends on keeping the two phases well stirred. Figure 8-66 shows the yield of mononitrotoluene as a function of the rate of stirring with a mixed acid consisting of 11 percent nitric acid, 64 percent sulfuric acid, and 25 percent water for a nitration time of 30 minutes. The results with the use of 40 percent oleum, which consists of 40 percent sulfur trioxide by weight dissolved in sulfuric acid, are analogous. However oleum is more reactive than sulfuric acid. The mononitration is carried out in the first nitrator where the temperature is lowest and the mixed acid has the highest water content. The low temperature reduces the amount of meta and of ring oxidation products formed. Mononitration at -110°C followed by dinitration at 0°C to 25°C yields a product with one tenth the amount of these impurities as when nitration is carried out under normal conditions. This process, however, is much more costly than the one carried out at higher temperatures so is not used. Less degradation occurs because of the higher water content of the mixed acid.

Toluene is much easier to nitrate than benzene because of the presence of a methyl group compared with benzene. The reaction of introducing the first nitro group therefore proceeds very quickly, however the methyl group is readily oxidized. Mononitration also leads to oxidation of the ring and the formation of cresols. If the mixed acid is poor in nitric acid or if an insufficient amount of mixed acid is used, tar formation may take place. To counteract these undesirable effects an excess of mixed acid that is rich in nitric acid could be used. On the other hand, both excess HNO₃ and excess mixed acid favor oxidation processes. Thus a trade-off must be achieved. Other oxidation reactions proceed especially readily under drastic conditions which introduce several nitro groups at a high temperature. This effect is minimized by having multiple nitrators with small temperature differentials between them. A concentration gradient for DNT and TNT exists across the production line. Table 8-54 shows the change in concentration of the nitro body, nitrated material in a six nitrator system. Six nitrators were used in the three Radford production lines before an explosion destroyed one of the lines. The explosion occurred during faulty manual removal of white compound which had coated the nitrator cooling coils. To stop the formation of white compound, an oxidation product, the number of nitrators was increased from six to eight. Each nitrator was also fitted with a centrifugal separator rather than a gravity separator, as the six original nitrators had. This reduced the amount of nitrobody in the system at any given time. Another design of continuous process in current use is the British ROF Process. This procedure also involves multistage countercurrent contacting, with the monoto-trinitration unit comprising a rectangular box-shaped vessel subdivided into eight stirred nitrator stages with intervening unstirred nitrobody-acid transfer sections. Mononitration is conducted separately in a smaller, similar vessel. This design desirably eliminates all interstage pipework and ductwork connections. This equipment applies to the use of 96 percent sulfuric acid, which requires more staging to affect complete nitration than in the case of the Radford plant, which employs 40 percent oleum. A comparison of the two systems shows that both give an 85 percent yield based on toluene, and

that both have the same nitric acid requirement. Radford usage of sulfuric acid is about 79 percent that of the ROF process, calculating both on the basis of a strength of 96 percent. The ROF system employs a lower temperature for mononitration, 35°C to 42°C vs 50°C to 56°C for the Radford process. In West Germany, mononitration is affected by a continuous process, but di- and trinitration are conducted batchwise, because of a high purity requirement. Trinitration is affected with mixed acid comprising 24 percent HNO₃, 70 percent H₂SO₄, and 6 percent SO₃. The reaction requires six hours with slowly rising temperatures. These conditions remove the dinitrotoluene isomers more completely than is possible with the much shorter reaction time used in continuous operation.

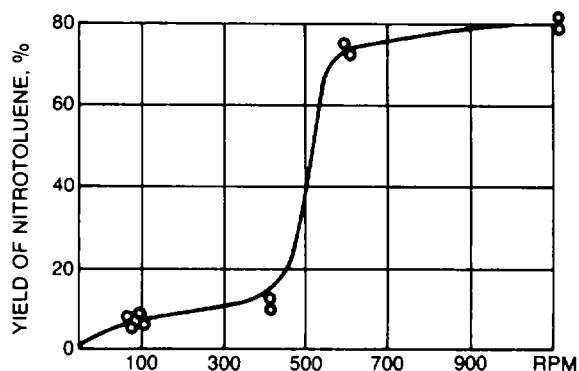

Figure 8-66. Agitation versus MNT yield.

(6) A problem associated with TNT production is the disposal of tetranitromethane (TNM), a toxic, odorous, and explosive material which is obtained in the exit gas from the trinitration step to the extent of about 136 grams to 227 grams per 45.4 grams of TNT. Venting TNM to the atmosphere is now illegal. The TNM can be recovered by scrubbing the gas with aqueous sodium carbonate containing stabilized hydrogen peroxide, which converts the TNM to nitroform. Nitroform is a raw material for making energetic plasticizers. Another objectionable effluent from TNT production is oxides of nitrogen (NO_x). These can be removed (>95 percent) by oxidation to nitric acid, followed by scrubbing with sulfuric acid.

Table 8-54. Nitrobody Concentration for a Six Nitrator System

Nitrator Temperature (°C)	1 50-55	2 70	3 80-85	4 90	5 95	6 100
Composition of nitrobody:						
MNT(%/o)	71.1%	-	-	-	-	-
DNT(%/o)	18.2	70.9	30.4	10.3	1.6	0.2
TNT(%/o)	4.2	28.9	69.3	89.5	98.2	99.7

(7) After nitration, the crude TNT requires purification. The ultimate objective of TNT purification is to remove all those products produced during nitration which are more reactive than TNT or which can easily give oily exudation products. Oil exudation from TNT is an undesirable characteristic for the following reasons:

(a) Exudation produces porosity of the TNT charge and the corresponding reduction in density. This reduces the explosive effect. In artillery shells this can produce a dislocation of the charge on firing, compression of the air included in the cavities, and premature explosion.

(b) The oily products can penetrate into the threaded parts of the shell and form "fire channels" through which the ignition of propellant can ignite the charge.

(c) The oily products can penetrate into the detonating fuze if the explosive of the fuze is not protected by a metal envelope, and reduce the detonating power of the fuze.

(8) Table 8-55 lists the impurities that are formed during the manufacture of TNT and the amounts contained in the product after purification. The concentrations listed in the table are maximum values; the actual values are lower.

Table 8-55. Impurities Present in TNT

Compound	Approximate maximum nominal concentration (%)	
	Crude	Finished
	2,4,5-Trinitrotoluene	2.50
2,3,4-Trinitrotoluene	1.75	0.20
2,3,6-Trinitrotoluene	0.50	0.05
2,3,5-Trinitrotoluene	0.05	0.05
3,4,5-Trinitrotoluene	0.006	
2,6-Dinitrotoluene	0.25	0.25
2,4-Dinitrotoluene	0.50	0.50
2,3-Dinitrotoluene	0.05	0.05
2,5-Dinitrotoluene	0.10	0.10
3,4-Dinitrotoluene	0.10	0.10
3,5-Dinitrotoluene	0.01	0.01
1,3-Dinitrobenzene	0.02	0.02
1,3,5-Trinitrobenzene	0.15	0.10
2,4,6-Trinitrobenzyl alcohol	0.25	0.25
2,4,6-Trinitrobenzaldehyde	0.25	0.25
2,4,6-Trinitrobenzoic acid	0.50	0.50
Alpha-nitrato-2,4,6-trinitrotoluene	0.10	0.10
Tetranitromethane	0.10	none
2,2'-Dicarboxy-3,3',5,5'-tetranitroazoxybenzene (white compound)	0.35	0.05
2,2',4,4',6,6'-Hexanitrobibenzyl (HNBB)	none	0.40
3-Methyl-2',4,4',6,6'-pentanitrodiphenylmethane (MPDM)	none	0.40
3,3',5,5'-Tetranitroazoxybenzene	none	0.01

Of the TNT isomers formed, only the first two listed in the table, the 2,4,5- and 2,3,4-isomers, are present in significant quantities. The dinitrotoluenes result from incomplete nitration. The next eight compounds listed in the table result, directly or indirectly, from oxidation of the methyl group during nitration, while the last three are introduced during purification. The purification process currently in use involves treating TNT with aqueous

sodium sulfite called sellite. The meta TNT isomers react with the sodium sulfite to form water-soluble sulfonates by the following reaction:

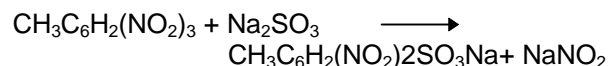

Current American practice entails continuous treatment of molten TNT, at a temperature greater than 80°C, with an aqueous solution containing about 0.1 part anhydrous sodium sulfite per part TNT. This corresponds to about four times the theoretical requirement according to the equation given above. The liquids are countercurrently contacted in three washers each of which is followed by a centrifugal separator. This purification process is quite sensitive to pH. Yield loss rises sharply above pH 7.5 because of the formation of the water soluble complex of 2,4,6-TNT with sodium sulfite. In addition, at pH values above about 8 the formation of the two by-products hexanitrobibenzyl (HNBB) and methylpentanitrodiphenylmethane (MPDM) increases strongly. These compounds have an adverse effect on the mode of crystallization of TNT. Table 8-55 shows that meta TNT isomers are not completely removed and that the amounts of all of the DNT isomers and of five of the oxidation products remain unchanged. The ROF TNT Process also employs continuous purification, using a compartmented reactor generally similar to that used by them for nitration. However, the TNT is contacted as a solid at 67.5°C, rather than as a liquid, as in the American process. This is said to result in a higher yield of purer TNT with a requirement of about two-thirds as much sodium sulfite. HNBB and MPDM are not formed. Advantage is taken of the fact that the unsymmetrical isomers form a eutectic which migrates to the crystal surface. This type of process is also employed in West Germany. The process is operated batchwise using 4 to 10 parts Na₂SO₃ per 100 parts TNT with a reaction time of 30 minutes. Use of this purification procedure, taken with a batch trinitration method which removes nearly all of the DNT isomers, yields a TNT of unusually high purity. The solidification point of the product is 80.65°C to 80.80°C. This type of process has also been used in the past in the United States. Disposal of the waste sellite solution, known as red water, is a serious pollution control problem. TNT can be purified by recrystallization from nitric acid. This process has been used for many years in Sweden. The nitric acid, after crystallization and filtration of the 2,4,6-isomer, is recovered by distillation leaving a mixture consisting of about 50 percent 2,4,6-TNT, 25 percent TNT meta isomers, and 25 percent dinitrotoluenes and oxidation products known as isotriol. The isotriol is then sold as an ingredient in commercial dynamite. Sweden has had trouble marketing isotriol, which is the major reason this otherwise attractive process has not been adopted elsewhere. Even after purification, military grade TNT typically shows 0.6 percent to 1.2

percent or more extrudate. A typical analysis of exudate from specification-grade TNT made in 1973 at the Radford Army Ammunition Plant by the continuous process is as follows:

2,4,6-TNT	88.19%
2,3,4-TNT	1.99%
2,4,5-TNT	0.67%
2,4-DNT	7.65%
2,6-DNT	0.98%
2,5-DNT	0.19%

HNBB and MPDM also form eutectics with TNT. Two approaches have been considered for minimizing extrudation. One approach to solving the extrudation problem is to produce TNT with smaller amounts of impurities. This can be done by carrying out nitration under more drastic conditions, which adds to the process cost, and closely controlling the sellite process to minimize production of HNBB and MPDM. Crystallization from nitric acid removes all DNT isomers. Another approach is to add materials to the TNT that absorb the eutectics. Cellulose esters, in the amount of about 0.6 percent, absorb the extrudate and reduce the tendency of the TNT to crack. Polyurethanes remove extrudate and double the compressive strength of the cast.

(10) Two types of TNT are specified for military use:

	Type I	Type II
Form	Flake or crystalline	Crystalline
Color	No darker than number 30257	Light yellow
Solidification point (°C), minimum	80.20	80.40
Moisture (%), maximum	0.10	0.10
Acidity (%), maximum	0.005	0.005
Alkalinity	None	None
Toluene insoluble matter (%), maximum	0.05	0.05
Sodium (%), maximum	0.001	0.001
Granulation		
through a US standard number 14 sieve	95	100
through a US standard number 100 sieve	-	95

For type I flake form the average thickness of the flakes shall not be more than 0.63 millimeters (0.025 inches) and any individual flake shall be no more than 0.1 millimeters (0.004 inches).

(11) TNT is one of the least sensitive of military explosives; only ammonium picrate, nitroguanidine, and ammonium nitrate are less sensitive. Impact tests yield high values relative to other military explosives, but impact sensitivity increases sharply with increasing temperature, as shown in table 8-56. Diminishing sensitivity has been reported down to- 196°C. Gap and projectile test results indicate cast TNT is less sensitive than the pressed materiel. Test results from the mod-

Table 8-56. Impact Sensitivity of TNT

Temperature in °C	Inches on Picatinny Arsenal apparatus with 2 kilogram weight
-40	17
Room	14
80	7
90	3
05	2 (five explosions in 20 trials)

Table 8-57. Gap Test Results for TNT

	Density grams per cubic centimeter	Percent voids	Sensitivity in millimeters
NSWC small scale gap test	1.651	0	3.96
	1.561	5.5	6.25
	1.353	18.0	7.90
LANL small scale gap test	1.633	1.3	0.33
	0.84	49.2	NO GO
	0.77	53.4	4.11
LANL large scale gap test	0.87 (flake)	47.4	37.1
	0.73 (granular)	55.9	60.8

ified gap test for cast and pressed TNT are shown in table 8-57. Finely divided TNT, as obtained by fume condensation, is more sensitive to impact than the crystalline material. TNT which has been exposed to light is also more sensitive. The pendulum friction test does not affect TNT. The material is insensitive to rifle bullet impact at room temperature whether unconfined or confined in iron, tin, or cardboard bombs. The same results are obtained at the temperature between 105°C and 110°C with tin or cardboard bombs and in the iron bomb with an airspace. In an iron bomb with no airspace 70 percent of the trials resulted in explosions. The explosion temperature for unconfined TNT is 475°C which is much higher than for other commonly used military explosives. Explosion temperatures for confined samples depend on the purity of the sample and test conditions. Results in the range of 275°C to 295°C are obtained. Heating in a closed glass capillary tube yields a value of 320°C to 325°C. TNT has high

minimum detonating charge values for initiation by lead azide or mercury fulminate. The dry material can be detonated by a number six electric blasting cap but the presence of only 7 percent moisture prevents detonation. This is compared to 14 percent and 35 percent moisture required for the desensitization of RDX and PETN respectively. TNT pellets pressed from flake TNT undergo substantial reductions in the rate of detonation and sensitivity to initiation after storage for one week at 65°C. These changes are accompanied by exudation of oily impurities, recrystallization, and sementation of the TNT. TNT is not classified as dangerous with respect to hazard from electric sparks. The sensitivity to electric discharge for 100 mesh TNT is 0.06 joules unconfined and 4.4 joules confined. The fine dust of TNT is sensitive to electric sparks. When ignited in free air, the dust burns completely without detonation; and the temperature of the liquid phase must be 510°C if detonation is to

result from burning. Even when it is under a gas pressure of 100 psi, the liquid phase temperature must be greater than 285°C if TNT is to burn with subsequent explosion. Figure 8-67 shows the results of trials of the Susan test for TNT.

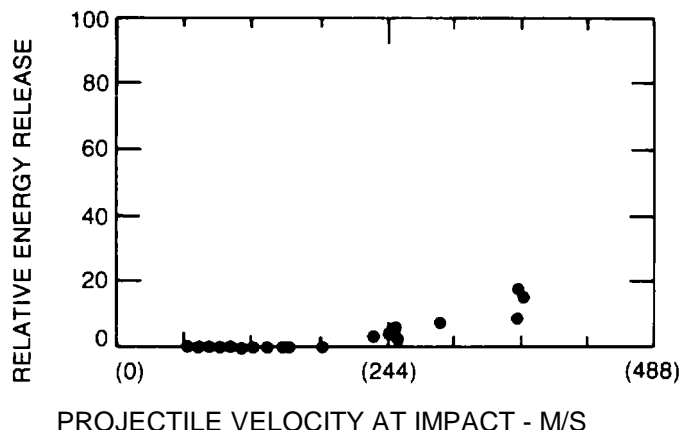

Figure 8-67. Susan test results for TNT.

(12) TNT is the standard explosive to which all the other explosives are compared. In the sand test, 48 grams of sand are crushed. The detonation velocity may be computed by the following equations:

$$D = 1.873 + 3.187p \quad \text{for } 0.9 < p < 1.534$$

$$D = 6.762 + 3.187(p - 1.534) - 25.1(p - 1.534)^2 \quad \text{for } 1.534 < p < 1.636$$

Table 8-59. Fragmentation Effects of TNT

Density in grams per cubic centimeter	Pressed/cast	Average number of fragments produced	Average velocity of fragments in meters per second
1.54	pressed	1,070	3,620
1.58	cast	1,850	3,570

The Chapman-Jouguet particle velocity at 1.59 grams per cubic centimeter is 1.83 kilometers per second. The Von Neumann peak pressure at 1.614 grams per cubic centimeter is 237 kilobars. The critical charge diameter of stick charges of TNT is influenced by several factors including initial density, grain size, initial temperature, and degree of crystallivity. TNT cast with many crystallization centers, as is obtained by adding TNT seed crystals to the melt just before solidification, has a smaller critical diameter than that made by conventional crystallization from a clear melt. Cast and pressed

charges of the same density have very different critical diameters. The reaction time of pressed TNT is less than half that of the cast material. Axially oriented TNT crystals show unstable detonation while radially oriented crystals detonate smoothly. TNT detonation products vary with the degree of confinement as shown in table 8-60. Increasing confinement shifts the formation of carbon monoxide to that of solid carbon, and the formation of hydrogen gas to that of water. The degree of conversion of the nitrogen atoms to elemental nitrogen remains consistent regardless of confinement.

Table 8-58. Detonation Pressure of TNT

Density in grams per cubic centimeter	Detonation pressure in kilobars
1.59	202
1.63	190
1.64	190
1.65	222

In the copper and lead cylinder compression tests the cylinders are compressed 3.5 and 16 millimeters, respectively. The depth of the dent in the plate dent test is about 0.205 millimeters. The energy of detonation at 1.65 grams per cubic centimeter is 1,265 calories per gram or 4.10 joules per gram. At 1.62 and 1.64 grams per cubic centimeter 684 and 690 liters of gas are evolved, respectively. Fragmentation effects of pressed and cast TNT charges are shown in table 8-59.

Table 8-60. Effects of Confinement on TNT Detonation Products

Confinement	Product moles per mole of TNT						
	CO ₂	CO	C(s)	N ₂	H ₂ O	H ₂	NH ₃
Heavily confined	1.25	1.98	3.65	1.32	1.60	0.46	0.16
Both ends of cylinder open	1.07	2.56	3.28	1.34	1.40	0.74	-
Unconfined	0.06	5.89	1.01	1.36	0.17	2.31	0.02

Trace amounts of methane, hydrogen cyanide, and ethane were also detected. In the Trauzl test, 10 grams of TNT expand the cavity by 285 to 305 cubic centimeters.

(13) TNT shows no deterioration after 20 years storage in a magazine or after two years storage as a liquid at 85°C. Only a small amount of decomposition occurs after storage at 150°C for 40 hours. Above that temperature slow decomposition occurs. Autoignition occurs after about 38 hours at 200°C. The thermal decomposition of liquid TNT is characterized by the sigmoidal curve typical of an autocatalytic reaction. Explosions occur after an induction period that varies with temperature. However, heating at the boiling point causes distillation but not explosion in small samples. TNT vapor was found to undergo no decomposition over the range 250°C to 301°C at 35 to 500 torr. Even at 357°C the vapor does not explode although decomposition is quite extensive. As shown in figure 8-68, differential thermal analysis indicates an endotherm at 75°C to 100°C and an exotherm at 260°C to 310°C. The TGA curve is shown in figure 8-69. Although at least 25 products are formed, the major products obtained by heating a sample of TNT for 26 hours at 200°C are:

Unreacted TNT	75-90%
Explosive coke	0-13%
4,6-Dinitroanthranil	2-4%
2,4,6-Trinitrobenzaldehyde	1-2%
Azo and azoxy compounds	0.4%
2,4,6-Trinitrobenzyl alcohol	0.2%

The structure of 4,6-dinitroanthranil is shown in figure 8-70. The explosive coke is a brown, intractable powder, apparently polymeric, melting about 360°C, and containing nitro groups. The infrared spectrum indicates the presence of the nitro groups. Since similar results were obtained from heating TNT in an inert atmosphere and exposed TNT to air, oxidation must have occurred at the expense of nitro groups which would

correspondingly be converted to azo or azoxy compounds or to an anthranil by inter- and intramolecular reaction, respectively, with the methyl groups. The most likely type of azoxy compound formed is shown in figure 8-71. Polymerization and crosslinking by reactions of this type can explain the formation of the explosive coke. The compound of the gases evolved was found to vary with the extent of reaction and with the temperature. The complicated nature of the process is shown by the fact that the evolved gases contain not only water, corresponding to the formation of the products cited above, but also CO, N₂, NO, N₂O, and even acetylene. Rupture of the C-H bond in the methyl group is the rate determining step in thermal decomposition of TNT. The activation energy of thermal decomposition is 40.9±1.6 kilocalories per mole during the induction period and 30.2±0.6 kilocalories per mole for the post induction period. Added nitroaromatic compounds have no effect on the rate of thermal decomposition of TNT. Nitramine and aliphatic nitrated esters have only a slight effect. Strong promoters of decomposition include potassium nitrate, potassium chloride, certain iron and cobalt compounds, and ammonia. Other active compounds include: hydroquinone, benzoic acid, activated carbon, various plastic materials used to seal or line ordnance, trinitrobenzaldehyde, 4,6-dinitroanthranil and explosive coke. The last three compounds are thermal decomposition products of TNT. Aluminum oxide has a pronounced effect, while PbO, Fe, Al, and Fe₂O₃ are less effective in that order, and Sn and CuO have little or no effect. Previous exposure to ultraviolet light for several hours also accelerates thermal decomposition. Moisture has no effect on the stability of TNT, which is unaffected by immersion in sea water. However, at 50°C ethanol reacts with alpha or gamma but not beta TNT. In case of alpha TNT the products are ethyl nitrite and an unidentified nitrocompound that melts at 77.5° to 77.9°C and is soluble in exudate oil.

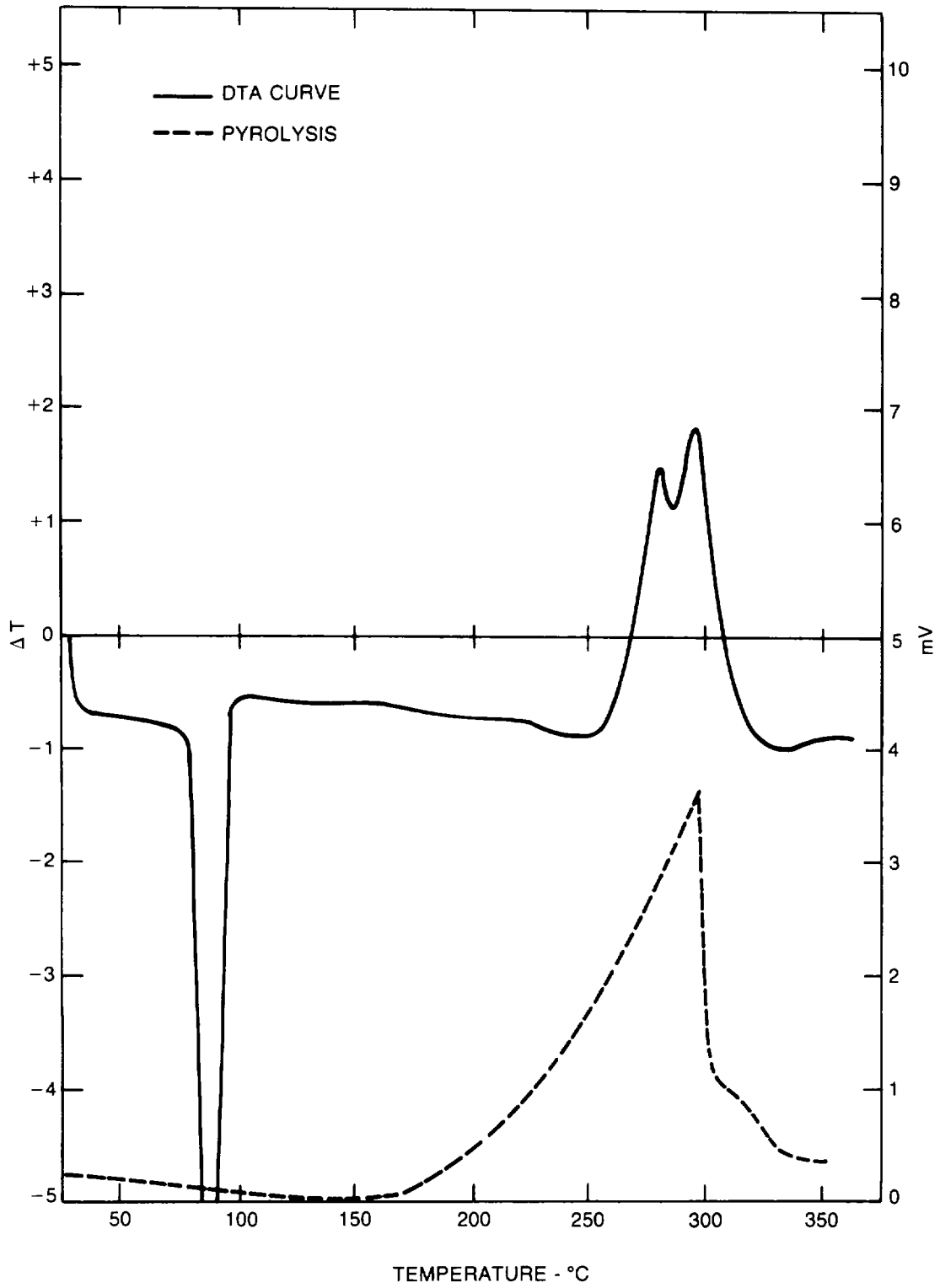

Figure 8-68. DTA curve for TNT.

FRACTION OF ORIGINAL SAMPLE AS PERCENT OF WEIGHT

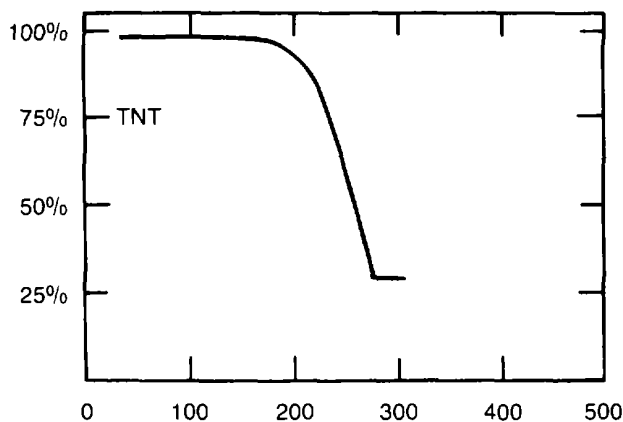

Figure 8-69. TGA curve for TNT.

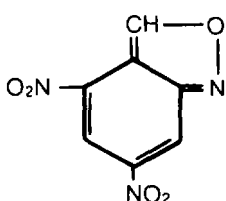

Figure 8-70. 4,6-Dinitroanthranil.

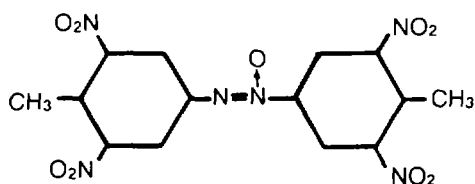
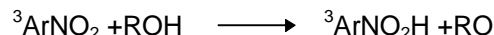

Figure 8-71. Explosive coke azoxy compound.

(14) Photolysis of aqueous solutions of TNT, such as the wastes obtained from munition plants, leads to the formation of pink water. Ultraviolet light excites the nitro group to a triplet state according to the equation:



Where Ar represents the aryl radical, which is the aromatic benzene ring with one hydrogen atom removed. The high energy triplet state extracts the hydrogen from the hydroxyl group of certain phenols according to the equation:



This reaction is reversible and occurs with certain other nitro compounds. Flash photolysis of TNT entails intramolecular hydrogen abstraction from the methyl group by the ortho nitro group according to the reaction shown in figure 8-72. Reaction sequence (1) has been identified in nonpolar solvents. Reaction sequence (2) has been identified in solar or basic solvents. Photoexcitations of TNT at 215°C in the gas phase or at room temperature in certain solvents, especially dioxane, leads to the formation of 2,4,6-trinitrobenzyl free radicals. Ultraviolet irradiation of aqueous solutions of TNT has yielded a mixture of products, 15 of which have been identified. The methyl group has undergone reaction in all cases yielding one of the following compounds: an alcohol, an aldehyde, a carboxyl, or a derivative of one of these compounds. A nitro group has reacted in some cases, but this is always the ortho and never the para group to the methyl group. Solid TNT produces trinitrobenzoic acid upon exposure to light.

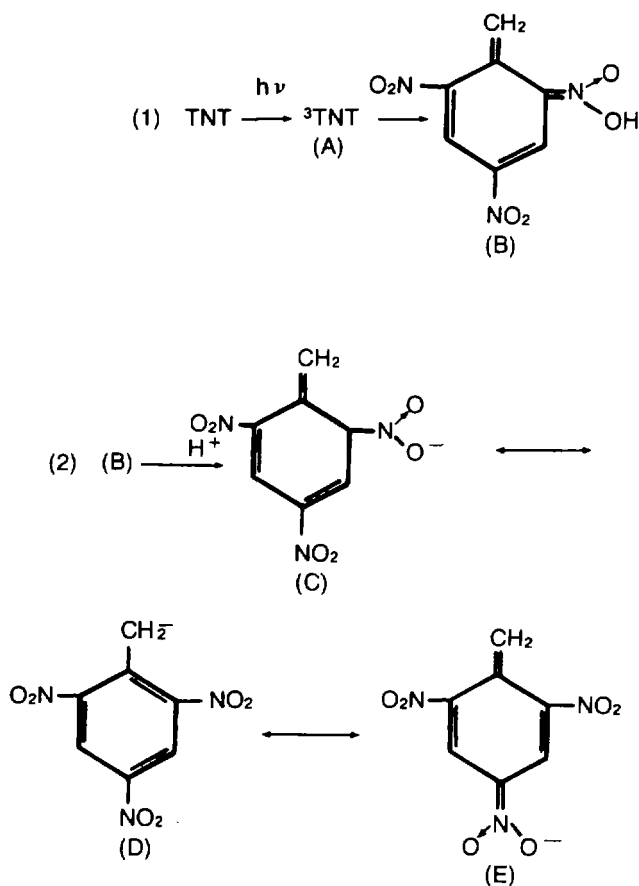

Figure 8-72. Photoexcitation of TNT.

8-5. Ammonium Nitrate.

a. Ammonium nitrate (figure 8-73) has a nitrogen content of 35 percent, an oxygen balance to H₂O and N₂

of 20 percent, and a molecular weight of 80.05. The crystal modifications of ammonium nitrate are shown in table 8-61.

Table 8-61. Crystal Modifications of Ammonium Nitrate

Form	Crystal system	Density in grams per cubic centimeter	Range °C
Liquid			Above 169.6
I Epsilon	Regular (cubic) (isometric)	1.58 to 1.61	125.0 to 169.6
II Delta	Rhombohedral or tetragonal	1.64 to 1.67	84.1 to 125
III Gamma	Orthorhombic	1.64 to 1.66	32.3 to 84.1
IV Beta	Orthorhombic	1.71 to 1.75	-18 to 31.2
V Alpha	Tetragonal	1.70 to 1.72	-18 to -150

The density of the molten material in grams per cubic centimeter is 1.402 and 1.36 at 175°C and 200°C, respectively. When heated at atmospheric pressure, decomposition occurs at 230°C and deflagration occurs at 325°C. There may even be decomposition at temperatures as low as 100°C since constant weight cannot be obtained at this temperature and decomposition is quite perceptible above the melting point. The boiling point of the pure material is 210°C. Distillation without decomposition can be carried out at 11 torr. On the Mohs scale a scratch hardness of 1.1 is reported. Specific heat values as a function of temperature are listed in table 8-62.

Table 8-62. Specific Heat of Ammonium Nitrate

Temperature in °C	Specific heat in calories per gram per degree centigrade
-200	0.07
-150	0.19
-100	0.30
-80	0.35
-50	0.37
0	0.40
50	0.414
100	0.428

The heat of fusion is 18.23 calories per gram. The heat of formation is 88.6 kilocalories per mole. Under constant pressure, the heat of combustion is 49.4 kilocalories per mole and at constant volume, the heat is 50.3 kilocalories per mole. At 25°C the latent heat of sublimation is 41.8 kilocalories per mole.

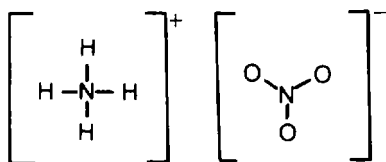
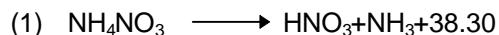

Figure 8-73. Structural formula for ammonium nitrate.

b. Ammonium nitrate can decompose according to any of the nine equations listed below. Unless otherwise stated, the heats of decomposition are based on solid phase ammonium nitrate. For molten ammonium nitrate add about 4,000 calories per mole to the values. The values for the heat liberated are at constant

pressure and 18°C for solid ammonium nitrate with all decomposition products in gaseous form. None of these reactions occur as a single reaction, but are always accompanied by other reactions. The predominate reactions are the ones listed in (2) and the two listed in (7):



kilocalories. This reaction takes place at a temperature somewhat above the melting point of ammonium nitrate. The corresponding value for the solid salt is 41.70 kilocalories.

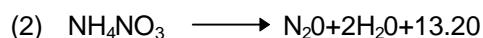

kilocalories with H₂O gas and 33.10 kilocalories for H₂O liquid. For the same reaction the value of 10.7 kilocalories has been reported. This reaction takes place in the temperature range of 180°C to 200°C when the ammonium nitrate is unconfined. Oxides other than N₂O form at 203°C to 285°C. Decomposition at 260°C is accompanied by puffs of white smoke.

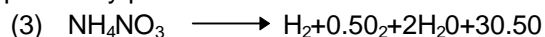

kilocalories for H₂O gas or 50.40 for H₂O liquid. For the same reaction, values from 27.72 to 30.50 kilocalories are reported for H₂O gas. This reaction takes place when ammonium nitrate is heated under strong confinement or when initiated by a powerful detonator. This is the principal reaction of complete detonation of ammonium nitrate. According to calculations, this reaction develops an approximate temperature of 1,500°C and pressure of 11,200 kilograms per square centimeter. The gas evolved is calculated to be 980 liters per kilogram at standard temperature and pressure.



kilocalories for H₂O gas or 28.90 kilocalories for H₂O liquid. A value of 6.87 kilocalories has also been reported for the reaction with the H₂O gas. This may be one of the side reactions taking place during incomplete detonation. A pressure of 4,860 kilograms per square centimeter and a temperature of approximately 518°C are developed.

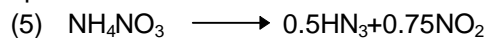

+0.25NO +0.25N₂ + 1.25H₂O -21.20 kilocalories. This is a reaction of decomposition that occurs when ammonium nitrate is under confinement at 200°C to 260°C. This endothermic reaction is followed, at 260°C to 300°C, by explosion of the gaseous products of reaction. This explosion is an exothermic reaction liberating 48.49 kilocalories of heat which is more than 1.5 times as great as the heat liberated by reaction (3) above.

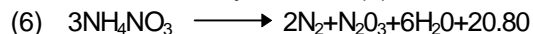

kilocalories for H₂O gas or 40.60 for H₂O liquid. A value of 21.80 has also been reported for the reaction with the H₂O gas. This reaction cannot take place alone because N₂O₃ exists only in the dissociated state as NO + NO₂.

(7) $4\text{NH}_4\text{NO}_3 \longrightarrow 2\text{NO}_2 + 3\text{N}_2 + 8\text{H}_2\text{O} + 29.80$
kilocalories for H₂O gas or 49.80 kilocalories for H₂O liquid. A value of 24.46 has been reported for the reaction with the H₂O gas. This is another possible side reaction occurring during incomplete detonation. For this reaction, a similar endothermic reaction can take place:

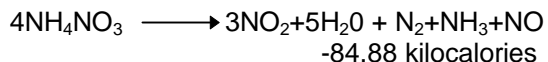

If the gaseous products are heated, an explosive exothermic reaction takes place.

(8) $5\text{NH}_4\text{NO}_3 \longrightarrow 2\text{HNO}_3 + 4\text{N}_2 + 9\text{H}_2\text{O}$
+35.10 kilocalories for H₂O gas or about 55 kilocalories for H₂O liquid with HNO₃ dissolved. This reaction takes place under certain conditions such as in the presence of spongy platinum and gaseous HNO₃.

(9) $8\text{NH}_4\text{NO}_3 \longrightarrow 16\text{H}_2\text{O} + 2\text{NO}_2 + 5\text{N}_2$
+16.58 kilocalories. This reaction takes place during incomplete detonation and is accompanied by a yellow flame. The calculated value for the total gas developed by this reaction is 945 liters per kilogram.

c. Ammonium nitrate decomposed by strong alkalis liberates ammonia and decomposed by sulfuric acid forms ammonium sulfate and nitric acid. In the presence of moisture, ammonium nitrate reacts with copper to form tetraminocupric nitrate, Cu (NO₃)₂ 4NH₃, which has the same sensitivity to impact and brisance as lead azide. For this reason tools of brass and bronze are not used in operations with explosives containing ammonium nitrate.

d. Ammonium nitrate can be manufactured by several methods. The most common method is by passing ammonia gas into 40 percent to 60 percent nitric acid. Both the ammonia and nitric acid are produced by a catalytic process from atmospheric nitrogen, so the ammonium nitrate obtained is of very high purity. The solution is then concentrated in evaporating pans provided with air agitation and heating coils. To form ammonium nitrate crystals, one of three methods is used. One method involves transferring the material that has fudged in the evaporating pan to a flat grainer that is equipped with slowly rotating stainless steel paddles. Stirring in the open cools the syrup, drives off the remainder of the water and produces small, rounded crystals of ammonium nitrate. Another method involves transferring the solution, which has been concentrated to about 95 percent, from the evaporating pan to the top of a spraying tower. In the tower the solution is sprayed and allowed to fall where the remainder of the moisture evaporates and spherical grains, about the size of buck shot, of ammonium nitrate

are formed. The grains are called prills. In the third method crystals are formed by vacuum evaporation at two torr, centrifuging, and drying to remove the remaining one to two percent moisture.

e. Ammonium nitrate used for military purposes must meet the following requirements:

Moisture:

Maximum, 0.15 percent.

Ether-soluble material:

Maximum, 0.05 percent.

Water-insoluble material of ether-extract:

Maximum, 0.10 percent.

Water-insoluble material:

Retained on a 250 micron (No. 60) sieve, none.

Retained on a 125 micron (No. 120) sieve.

Maximum, 0.01 percent.

Acidity, as nitric acid:

Maximum, 0.02 percent.

Nitrites:

None.

Chlorides, as ammonium chloride:

Maximum, 0.02 percent.

Phosphates, as diammonium phosphate:

0.21 ± 0.04 percent.

Sulfates, as diammonium sulfate:

0.007 to 0.014 percent.

Boric acid:

0.14±0.03 percent.

Ammonium nitrate:

Minimum, 98.5 percent.

Density:

Particle, g/ml.

Minimum, 1.50.

Bulk, g/ml.

Minimum, 0.80.

Bulk, lbs/cu ft.

Minimum, 50.0.

pH:

5.9 ± 0.2.

Granulation (percent by weight):

Through a 3360 micron (No. 6) sieve.

Minimum, 99.0.

Retained on a 1680 micron (No. 12) sieve.

50.0 - 85.0.

Retained on a 840 micron (No. 20) sieve.

Minimum, 97.0.

Through a 500 micron (No. 35) sieve.

Minimum, 0.5

The material must be free of nitrite and alkali. The granulation of ammonium nitrate is closely controlled so that satisfactory fluidity and density can be obtained in composition explosives.

f. Ammonium nitrate is the least sensitive to impact of any of the military explosives. Impact sensitivity varies with temperature as shown by the following data:

Temperature in °C	Impact height in inches (Picatinny apparatus)
25	31
100	27
150	27
175	12

The material is unaffected by the steel shoe in the pendulum friction test and does not explode in the five second explosion temperature test. Heating pure, unconfined ammonium nitrate produces a more or less rapid decomposition accompanied by a flash and a hissing sound but no explosions. If a crystal or a piece of cast ammonium nitrate is thrown upon a hot plate at a temperature of about 500°C, the material immediately catches fire and burns rapidly with a yellowish flame and a crackling or hissing sound, but leaves no residue. If a large piece of cast ammonium nitrate is thrown upon a red hot plate, the decomposition proceeds quickly enough to resemble an explosion. The minimum temperature at which a confined charge will explode is around 260°C to 300°C under a pressure of about 17,237 kilopascals (2,500 pounds per square inch). The sensitivity may be increased by the addition of powdered copper, iron, aluminum, zinc, chromium oxide, or chromium nitrate. Powdered limestone, kieselguhr, and clay reduce the sensitivity to heat. No explosions occur in the rifle bullet impact test. In the sand test, only partial explosion of ammonium nitrate results even if boosted with a charge of tetryl or RDX. Larger charges, when properly combined, can be detonated by means of a booster charge of tetryl but not by means of a lead azide or mercury fulminate blasting cap. If ammonium nitrate is unconfined, a number eight blasting cap will not cause complete detonation. The molten material is easier to initiate than the solid and the dry material easier to initiate than the moist. The sensitivity of ammonium nitrate to initiation decreases with increases in loading density. If the density exceeds 0.9, charges of one to three pounds cannot be detonated completely by large booster charges. Larger

quantities cannot be detonated completely at densities greater than 1.1. The admixture of up to eight percent of nonexplosive carbonaceous material somewhat sensitizes ammonium nitrate to initiation.

g. The brisance of ammonium nitrate cannot be measured in the sand test because of a failure to completely detonate. The lead cylinder compression test indicates a brisance of 54 percent of TNT for a sample with a density of 1.3 grams per cubic centimeter. Ammonium nitrate has a very low ability to propagate a detonating wave. In unconfined charges that are long and small in diameter, the detonating wave dies out before reaching the opposite end of the cartridge. Ammonium nitrate has a very low velocity of detonation. Factors affecting the velocity of detonation are density, degree of confinement, charge diameter, particle size, strength of the initiating impulse, temperature of the sample, and the presence of certain impurities such as organic materials or oxidizable metals. The rate of detonation increases with decreasing particle size. A decrease in the apparent density of the charge and an increase in confinement causes an increase in the velocity of detonation. An increase in the temperature of the charge from 15°C to 140°C results in an increase of 400 meters per second in the rate of detonation. Within certain limits an increase in the strength of the initiating agent, the diameter of the charge, and presence of organic compounds or oxidizable metals can increase the rate of detonation. The velocity of detonation varies from 1,100 meters per second to 3,000 meters per second. The Trauzl test indicates ammonium nitrate is 75 percent as powerful as TNT and the ballistic mortar test indicates a power of 79 percent of TNT at a density of 1.0 grams per cubic centimeter.

h. The vacuum stability test at 150°C indicates ammonium nitrate is a very stable material even at that temperature. Heating for 100 days at 100°C causes no appreciable decomposition. Decomposition does not appear to begin until the compound melts. At 220°C nitrous oxide, water, and nitrogen are formed. High temperature decomposition is used to manufacture nitrous oxide. If an organic material such as cellulose is present, decomposition of the mixture begins at 100°C and is pronounced at 120°C. The DTA curve for ammonium nitrate is shown in figure 8-74 and the TGA curve is shown in figure 8-75. Admixture with TNT has little if any effect on the stability of ammonium nitrate at temperatures less than 120°C.

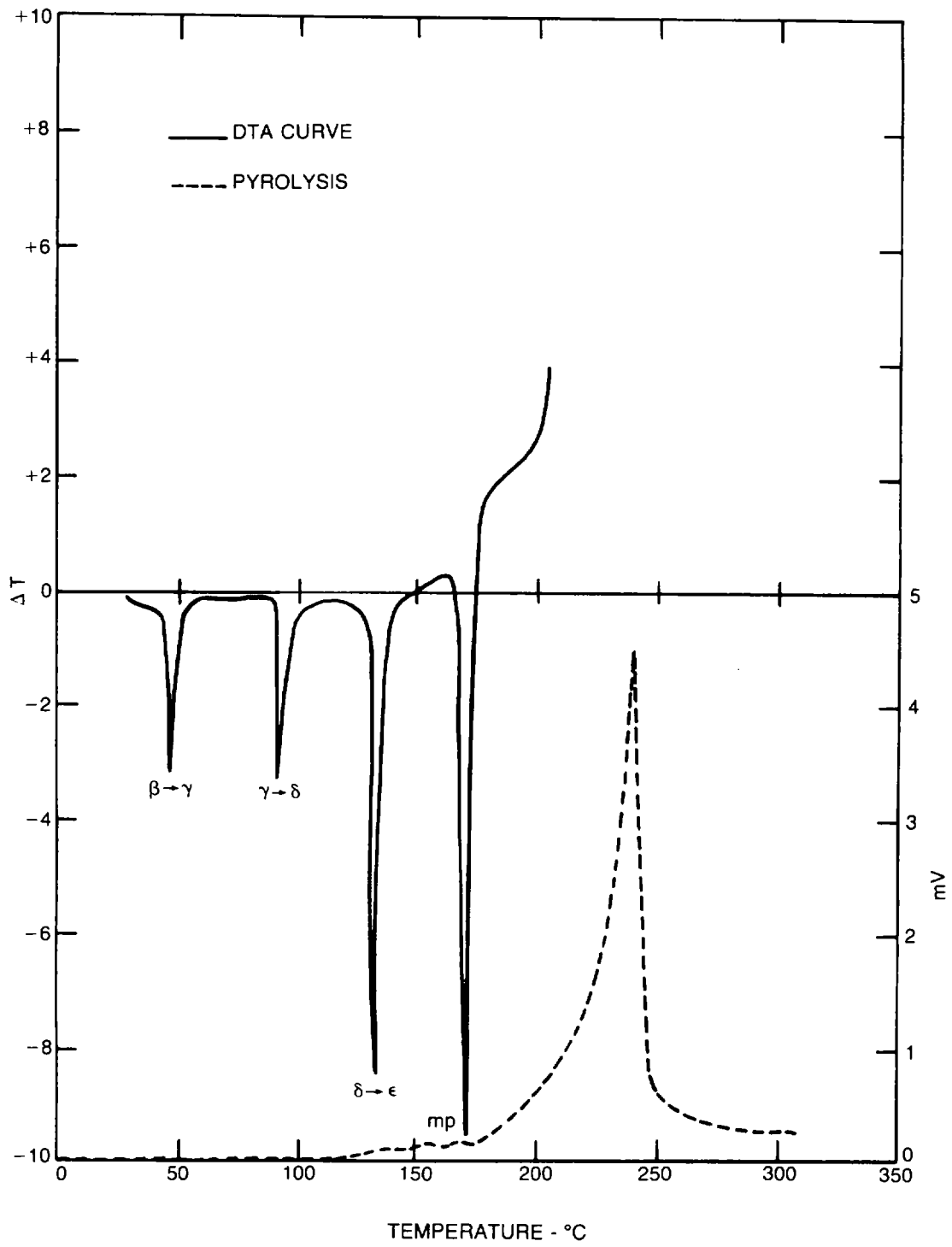

Figure 8-74. DTA curve for ammonium nitrate.

FRACTION OF
ORIGINAL SAMPLE
AS A PERCENT OF
WEIGHT

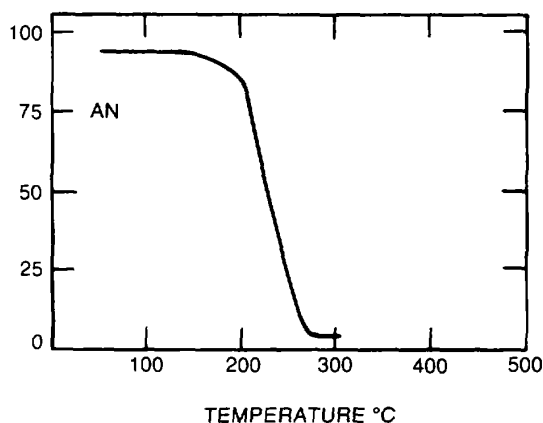

Figure 8-75. TGA curve for ammonium nitrate.

8-6. Compositions. Compositions are explosives in which two or more explosive compounds are mixed to produce an explosive with more suitable characteristics for a particular application. Generally, the characteristics of the composition are intermediate between the characteristics of the individual explosive ingredients. For example, the addition of TNT to RDX reduces brisance somewhat but considerably improves sensitivity. The composition explosives are categorized by the number of ingredients contained in the mixture.

a. *Binary Mixtures.*

(1) Amatols.

(a) Amatols are binary mixtures of ammonium nitrate and TNT. The percentages of ammonium nitrate and TNT are reflected in the nomenclature for each mixture, for example, 80/20 amatol consists of 80 percent ammonium nitrate and 20 percent TNT. Ammonium nitrate is insoluble in TNT. The chemical and physical properties of the constituents determine the properties of the amatol. The mixture begins to melt at TNT's melting point but the ammonium nitrate, which has a higher melting point, remains solid. The two ingredients may be dissolved separately. Table 8-63 compares the properties of some of the common amatol compositions. Amatols can be used for shell and bomb filling.

Table 8-63. Properties of Amatols

Properties	Amatol composition				
	80/20	60/40	50/50	45/55	40/60
Nitrogen content	31.7%	28.4%	26.8%	25.9%	25.1%
Oxygen balance to CO ₂	+ 1.20%	- 17.6%	-27.0%	-31.7%	-36.4%
Oxygen balance to CO	+ 11.06%	+2.13%	-2.32%	-4.55%	-6.78%
Color	Lt buff	Lt buff	Buff	Buff	Buff
Melting point, °C	-	-	81	-	-
Heat of combustion at constant volume	1,254	-	2,073	-	2,402
Specific heat 20° to 80°C	-	-	0.383	-	-
Heat of detonation with liquid water at constant volume in kilocalories per gram	1,04-1,200	-	950	-	920

(b) 80/20 amatol is manufactured by heating ground and screened ammonium nitrate to 90° 95°C in a mixing kettle with a steam jacket. The ammonium nitrate cannot contain more than 0.25 percent water and must be finely granulated. The proper amount of molten TNT at 95°C is gradually added with mechanical agitation. The mixture is thoroughly blended by continuing the agitation at 95°C for at least 15 minutes after the TNT has been added. The mixture is then suitable for press loading or extrusion. The explosive is a plastic mass resembling wet brown sugar. Improper granulation of the ammonium nitrate can, on loading, cause separation of the molten TNT. To manufacture amatols with a 60 percent or less ammonium nitrate content, molten TNT is placed in the steam jacketed kettle. The screened and dried ammonium nitrate, which has been heated to 90° to 95°C, is added with agitation at a rate that prevents lumping. Agitation at 90° to 95°C is maintained until thorough blending and uniform fluidity are obtained. The temperature of the mixture is then reduced to 85°C for cast loading. The

explosive resembles cast TNT.

(c) Impact tests indicate 80/20, 60/40, 50/50, and 40/60 amatols are 90 to 95, 95 to 100, 93 to 100, and 93 to 100 percent as sensitive as TNT, respectively. Amatols are unaffected by the rifle bullet impact test and the pendulum friction test. Explosion temperature test values for all the amatols are lower than that of TNT: 280°C to 300°C for 80/20 amatol, 270°C for 60/40 amatol, and 254°C to 265°C for 50/50 amatol. In the sand test 50/50 amatol is less sensitive to initiation than TNT, requiring a minimum charge of 0.05 gram of tetryl. However, 50/50 amatol can be detonated by diazodinitrophenol, and special tests have shown that less of this initiating agent is required to detonate cast or pressed 50/50 amatol than is required for cast or pressed TNT.

(d) Detonation characteristics for the amatols are listed in table 8-64. In the table, percentages are relative to TNT and density is given in grams per cubic centimeter.

Table 8-64. Detonation Characteristics of Amatols

	80/20 Amatol	60/40 Amatol	50/50 Amatol	40/60 Amatol
Brisance by sand test	74%	90%	90%	94%
Brisance by fragmentation test	-	81% at density of 1.53	82%at density	- of 1.55
Brisance by copper cylinder compression test	-	-	-	81% at density of 1.56
Power by Trauzl test	126%	-	116%	120%
Power by ballistic mortar test	130%	128%	123%	-
Detonation velocity in meters per second at 1.59 to 1.6 grams per cubic centimeter	5,300	6,200	6,400	6,550

Other experimental determinations of the velocity of detonation yields divergent results from those shown in the table, at least partially due to the variations caused by the granulation of the ammonium nitrate. Amatols have better oxygen balance than TNT producing larger amounts of gaseous explosion products. This accounts for the greater power of the amatols.

(e) The stability of 50/50 amatol is a little less than that of TNT at temperatures of 100° and 120°C as indicated by vacuum stability tests. There evidently is

very slight reaction between TNT and ammonium nitrate at those temperatures. At temperatures below the melting point of TNT, there is no evidence of reaction. After storage at 50°C for three months, there is no change in the sensitivity, brisance, or stability of 50/50 amatol; and many additional months of such storage without effect might be anticipated. The DTA curve for 80/20 amatol is shown in figure 8-76. Amatols are hygroscopic due to the presence of the ammonium nitrate.

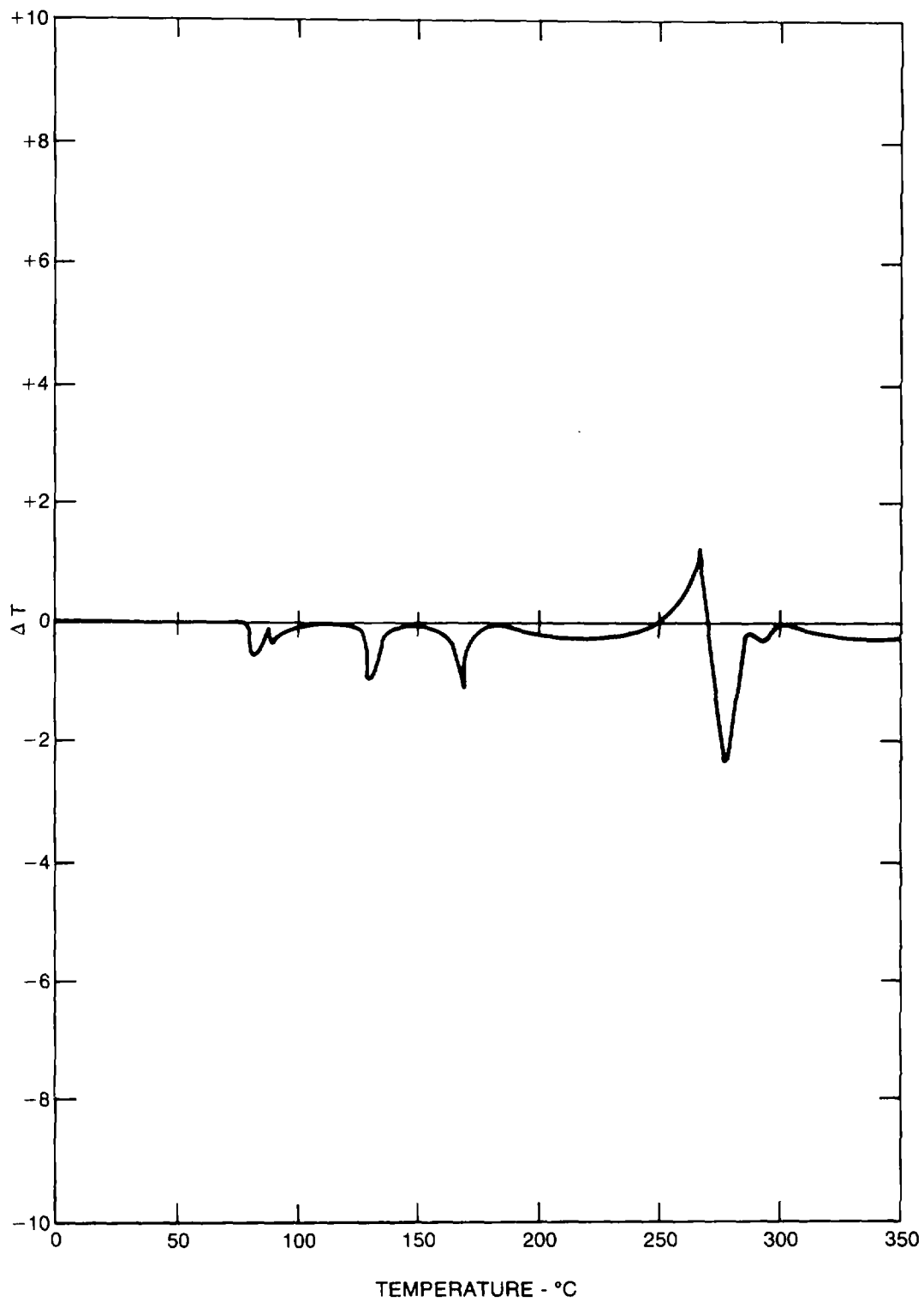

Figure 8-76. DTA curve for 80/20 amatol.

(f) 50/50 Amatol has an air blast energy of 84 percent of TNT, a water shock energy of 94 percent of TNT, and a shaped charge efficiency of 54 percent of TNT.

(g) Determination of the composition of amatol can be made by extracting a weighted sample with benzene, drying the residue, and weighing this. The weight of the residue is calculated to percentage of ammonium nitrate and the difference between this and 100 percent represents the percentage of TNT.

(2) Composition A.

(a) Composition A explosives consist of a series of formulations of RDX and a desensitizer. Table 8-65 lists the composition of the explosives. Compositions A and A2 contain the same percentages of materials as composition A3 but the type of wax used

and the granulation requirements for the RDX are different. Composition A contains beeswax, while composition A2 contains a synthetic wax. Compositions A and A2 are no longer used. All of the composition A explosives are press loaded. The density of composition A3 is 1.47 and 1.65 grams per cubic centimeter when pressed to 20,685 kilopascals (3,000 pounds per square inch) and 82,740 kilopascals (12,000 pounds per square inch), respectively. Composition A3 may be completely dissolved in benzene and acetone, when these solvents are used successively. The color of the composition depends on the color of the particular desensitizer used. For composition A3 the heat of formation is -24.8 to -28.4 kilocalories per gram and the heat of detonation is 1,210 kilocalories per gram.

Table 8-65. Composition A Explosives

Composition	Ingredients in percent				Comments
	RDX	Desensitizing wax	Stearic acid	Polyethylene	
A3	91.0±0.7	9.0±0.7	-	-	High explosive, projectile filler
A3 type 11	90.8±0.9	-	-	9.2±0.9	High explosive, projectile filler
A4	97.0±0.5	3.0±0.5	-	-	Boosters
A5 type 1	98.5±0.5	-	1.5±0.5	-	Shaped charges, grenades
A5 type 11	98.0 minimum	-	1.6 minimum	-	Also contains 0.4 percent lubricant
A6	86	14	-	-	Projectile filler

(b) The manufacture of composition A3 is carried out by heating a water slurry of RDX nearly 100°C and agitating. The wax, which contains a wetting agent, is added during agitation and agitation is continued while the mixture is allowed to cool to a temperature less than the melting point of the wax. After being caught on a filter, the composition is air-dried at 77°C.

(c) The relative impact sensitivity of composition A3 is 125 percent of TNT. There are no initiations in the rifle bullet impact test or pendulum friction test with either the steel or fiber shoe. The five second explosion temperature test result is 250°C to 280°C. In the booster sensitivity test, with material pressed to a density of 1.62 grams per cubic centimeter, detonations in 50 percent of the trials are caused by 100 gram tetryl pellets separated from the composition A3 by acrawax B pellets 4.318 centimeters (1.7 inches) thick. The minimum detonating charge of lead azide is

0.25 grams. The flammability index is 195 percent of TNT.

(d) The sand test indicates composition A3 is 107 to 115 percent as brisant as TNT and the plate dent test indicates 126 percent. In the fragmentation test a three inch shell containing 0.861 grams of composition A3 at a density of 1.64 grams per cubic centimeter produced 710 fragments versus 514 for the same weight of TNT. The fragment velocity at a distance of 2.75 meters (9 feet) is 853.44 meters per second (2,800 feet per second) and at a distance of 7.77 meters (25.5 feet) the fragment velocity is 771.14 meters per second (2,530 feet per second). The detonation velocity for a sample of composition A3 at a density of 1.62 grams per cubic centimeter is 8,100 to 8,200 meters per second. The Trauzl test and ballistic mortar indicate composition A3 is 144 percent and 135 percent of TNT, respectively.

(e) When subjected to the vacuum stability test for 48 hours at 100°C and 120°C composition A3 evolves 0.3 cubic centimeters of gas and 0.6 cubic centimeters of gas, respectively. These values are less for RDX, but slightly more for TNT. The 100°C heat test indicates that composition A3

undergoes volatilization. Composition A3 is nonhygroscopic, so is not affected by moisture during storage. Storage above 75°C is not recommended because of the softening effect on the wax coating. Figures 8-77 and 8-78 show the DTA curves for composition A and A3, respectively.

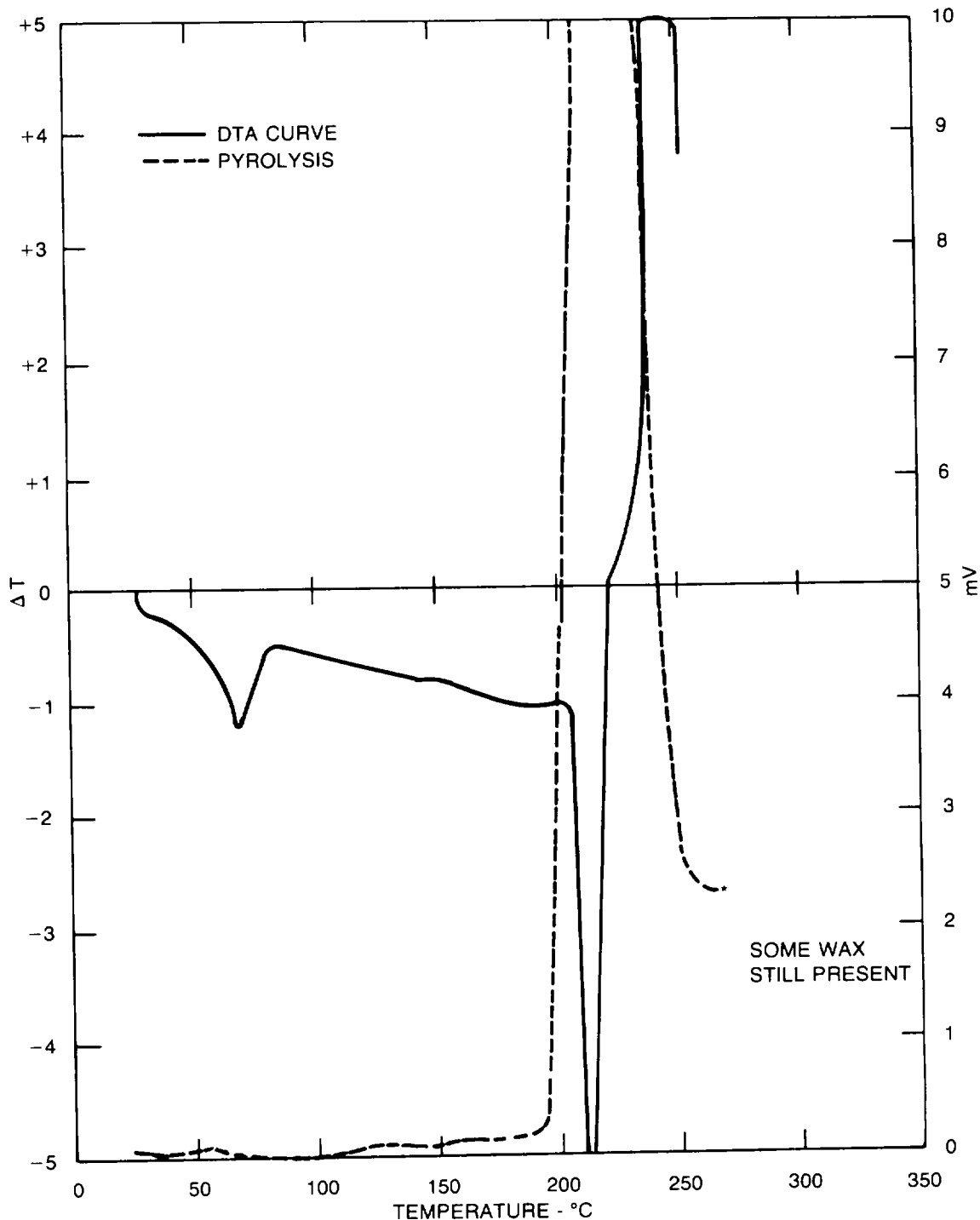

Figure 8-77. DTA curve for composition A.

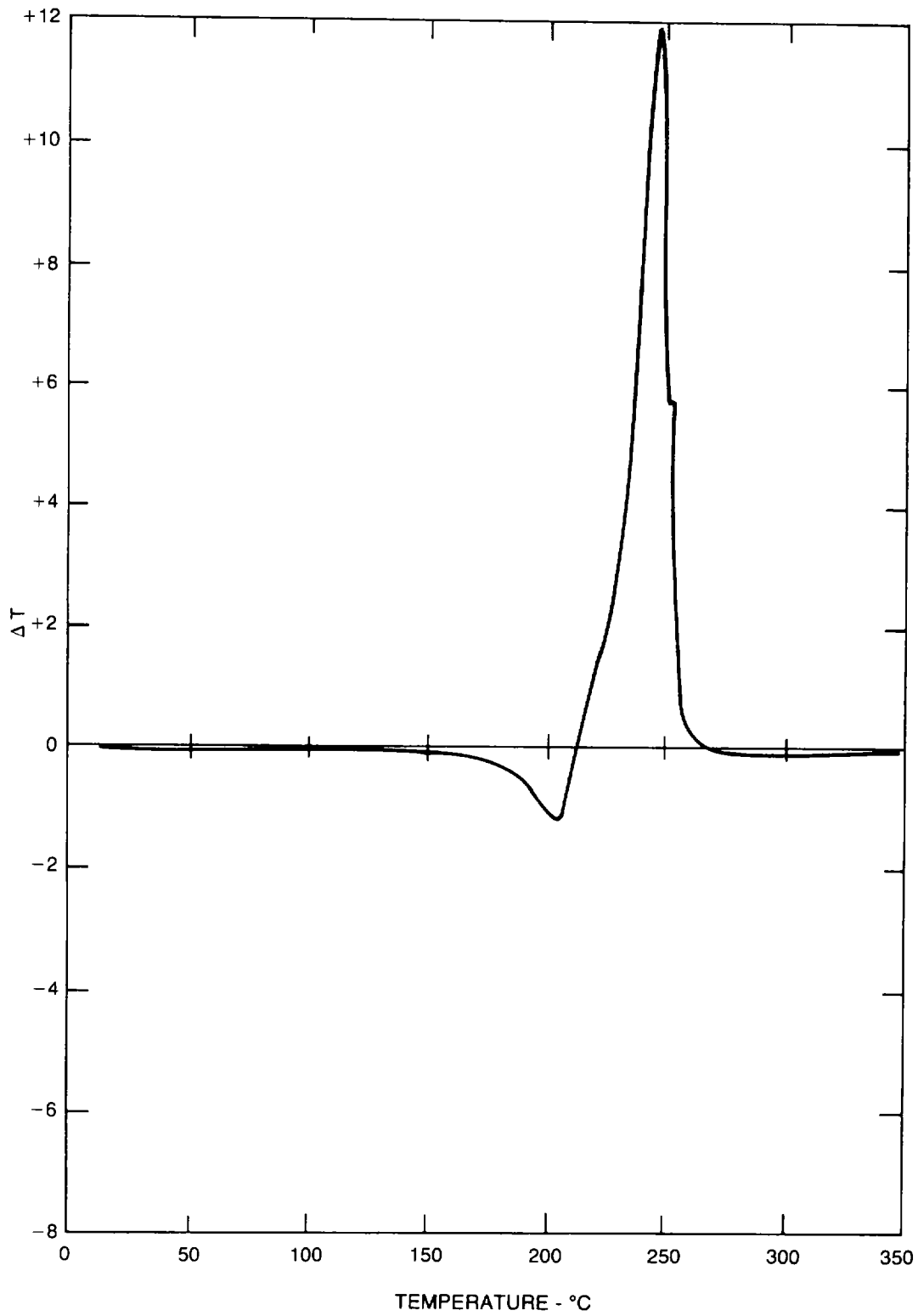

Figure 8-78. DTA curve for composition A3.

(3) Composition B.

percent TNT. Other portions of RDX and TNT are called cyclotols. Table 8-66 compares the properties of some composition B type explosives.

(a) Composition B type explosives are mixtures of RDX and TNT. Composition B refers to mixtures of approximately 60 percent RDX and 40

Table 8-66. Cyclotol Properties

Composition and properties	Cyclotol Type I	Cyclotol Type II A	Cyclotol Type II B	Composition B	Composition B2	Composition B3
Percent RDX	75±2	70±2	69.6±2.0	59.5±2.0	60	59.9±1.0
Percent TNT	25±2	30±2	29.9±2.0	39.5±2.0	40	40.5±1.0
Percent wax	-	-	1±.03	-	-	-
Calcium silicate	-	-	0.5±0.15	-	-	-
Oxygen balance to CO ₂ ,%	-35	-37	-	-43	-43	-
Color of material	Yel-buff	Yel-buff	-	Yel-brown	Yel-brown	-
Castability at 90°C poured	Difficulty poured	Difficulty	- poured	Easily poured	Easily	-
Thermal characteristics (in units of calories per gram):						
Heat of combustion	2,625	2,685	-	-	2,820	-
Heat of explosion	1,225	1,213	-	-	1,195	1,200
Heat of fusion	5.0	-	-	-	-	-
Impact sensitivity properties with 2 kilogram weight:						
Bureau of Mines apparatus	-	60	-	75	75	-
Picatinny Arsenal apparatus	-	14	-	14	14	-
Weight of sample in milligrams	-	20	-	19	19	-
Rifle bullet impact test:						
Percent explosions	30	30	-	3	5	-
Percent partials (smokes)	40	30	-	13	55	-
Percent burned	0	0	-	4	25	-
Percent unaffected	30	40	-	80	15	-
Sensitivity to initiation (minimum detonating charge in grams)	-	LA 0.20 MF 0.21	-	LA 0.20 MF 0.22	LA 0.20 MF 0.22	-
Detonation characteristics:						
Brisance by plate dent test (percent TNT)	-	136	-	129 - 132	132	-
Brisance by sand test (percent TNT)	-	118	-	113	114	-
Fragmentation test:						
Number of fragments from 90mm HE, M71 shell	1,514	1,165	-	998	998	-
Weight of bursting charge in grams	1,008	1,005	-	993	993	-
Number of fragments from shell containing TNT	703	703	-	703	703	-
Fragment velocity in meters per second (feet per second)						
at distance 2.74 meters (9 feet)	-	-	-	896 (2,940)	903.7 (2,965)	-
at distance 7.77 meters (25 feet)	-	-	-	816.8	853.4	-

Table 8-66. Cyclotol Properties (Cont)

Composition and properties	Cyclotol Type I	Cyclotol Type II A	Cyclotol Type II B	Composition B	Composition B2	Composition B3
The value for TNT at 2.24 meters is 792 meters per second and at 7.77 meters is 719 meters per second.	-	-	-	(2,680)	(2,800)	-
Detonation rate in meters per second at room temperature for 2.54 centimeter diameter charge (d in grams per cubic centimeter)	8,252 at d 1.743	8,060 at d 1.73	-	7,840 at d 1.68	7,900 at d 1.72	-
Gas volume in cubic centimeters per gram	862	854	-	-	845	-
Stability tests:						
Heat test at 100°C:						
Percent loss in 1st 48 hours	0.07	-	0.2	-	-	-
Percent loss in 2nd 48 hours	-	0.08	-	0.2	-	-
Explosion in 100 hours	-	None	-	None	-	-
Hygroscopicity in percent at 30°C and 90% relative humidity	-	Nil	-	0.02	Nil	-
Vacuum stability test results in cubic centimeters evolved in 48 hours:						
at 100°C	0.23	-	-	0.7	-	-
at 120°C	0.41	0.86	-	0.9	0.29	-
at 150°C	-	-	-	11 +	-	-
Blast effect in air as a percent of TNT:						
Peak pressure	111	110	-	110	104	-
Impulse	126	120	-	110	116	-
Energy	-	-	-	116	-	-
Shaped charge effectiveness as a percent of TNT:						
Hole volume with glass cones	-	-	-	178	178	-
Hole volume with steel cones	-	-	-	162	162	-
Hole depth with glass cones	-	-	-	125	125	-
Hole depth with steel cones	-	130	-	148	148	-

(b) Composition B grade A is formulated as a 60/40 RDX/TNT mixture, but high quality castings usually are higher in RDX content because a TNT rich section is removed from the top of the casting. The casting has a nominal formulation of 36 percent TNT, 63 percent RDX, and 1 percent wax. The grade A composition B is also made from grade A RDX. The theoretical maximum density of both grades

A and B composition B is 1.737 grams per cubic centimeter, the open melt density is 1.68 to 1.70 grams per cubic centimeter, and the vacuum melt density is 1.715 to 1.720 grams per cubic centimeter. The theoretical maximum density of composition B3 is 1.750 grams per cubic centimeter and the vacuum melt density is 1.725 to 1.730 grams per cubic centimeter. 75/25 Cyclotol has a theoretical

maximum density of 1.776 grams per cubic centimeter and a vacuum melt density of 1.74 to 1.75 grams per cubic centimeter. 70/30 Cyclotol has a theoretical maximum density of 1.765 grams per cubic centimeter and an open melt density of 1.71 to 1.73 grams per cubic centimeter.

(c) RDX is slightly soluble in molten TNT and the two compounds form an eutectic mixture that freezes at 79.0°C and contains 95.84 percent TNT and 4.16 percent RDX. When heated, RDX undergoes some softening at a relatively low temperature because of the melting of the wax present and further melting at the eutectic temperature. As the temperature is increased, some of the RDX is dissolved and at 100°C there are in equilibrium 42.8 parts of molten solution and 57.2 parts of solid RDX. The viscosity of composition B as cast is an important characteristic that is affected markedly by the granulation of the RDX and the nature of the wax used, the wax causing an increase in the viscosity. Representative viscosity values for composition B at 83° and 95°C are 3.1 and 2.7 poises, respectively.

(d) Composition B is manufactured from TNT and water wet RDX. The TNT is melted at approximately 100°C in a steam jacketed melting kettle equipped with a stirrer. The damp RDX is added slowly with stirring, and after addition of the RDX is completed, most of the water is poured off and heating and agitation are continued until all moisture has been driven off. The wax is then added and mixed thoroughly with the other ingredients by stirring. The nature of the wax is important since only certain waxes mix with the RDX and TNT and do not tend to segregate during cooling. The thoroughly mixed composition B then is cooled with continued agitation until the fluidity is satisfactory for casting. The composition B is either cast directly into

bombs or solidified into chips approximately 4.8 square centimeters by .6 centimeters. The chips are produced when the composition B is to be stored or shipped for use elsewhere.

(e) Impact sensitivity for solid composition B is between that of TNT and RDX. Cast composition B is more sensitive than the powdered material. As judged by the pendulum friction test, powdered composition B is no more sensitive than TNT, and at 100°C the two explosives show no increase in sensitivity to friction. Like TNT, cast composition B can be drilled without undue hazard. The explosion temperature test value of composition B (270°) is only slightly greater than that of RDX, but the sensitivity of composition B to electrical sparks is more nearly that of TNT than that of RDX. Composition B is intermediate between TNT and RDX in sensitivity to initiation. Cast composition B is somewhat less sensitive to initiation than the pressed material. Table 8-67 lists the gap test results for composition B.

(f) Composition B3 behaves reasonably well in the Susan test. Ignition occurs at the beginning of the pinch stage only after extensive splitting and deformation of the nose cap. The threshold velocity is about 55 meters per second. The reaction level as a function of projectile velocity is shown in figure 8-79. Even at 457 meters per second the full potential of the reaction is not released. These results indicate composition B3 is difficult to ignite by mechanical means and has a low probability for violent reactions once ignited, provided confinement is light. Composition B3 has been observed to detonate in impact geometries where there was good inertial confinement at the time of ignition and where the impact subjected the charge to mechanical work.

Table 8-67. Gap Test Results for Composition B

	Density	Percent voids	Sensitivity in millimeters
LANL small scale gap test:			
Composition B, grade A	1.710 (cast)	1.1	0.41 - 0.66
Composition B3	1.721 (cast)	1.8	1.1 - 1.4
75/25	1.753 (cast)	1.1	0.25 - 0.41
LANL large scale gap test:			
Composition B, grade A	1.712 (cast)	2.2	44.58
Composition B3	1.727 (cast)	1.4	50.34
75/25 Cyclotol	1.757 (cast)	0.6	43.15
	1.734 (cast)	2.2	45.74
PX gap test:			
Composition B	1.714 (cast)	2.2	2

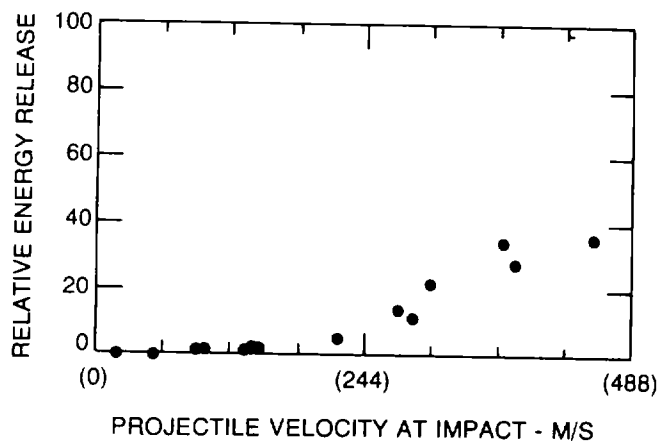

Figure 8-79. Susan test results for composition B3.

(g) 75/25 Cyclotol has both good and bad properties, as measured by the Susan test. The reaction level as a function of projectile velocity is shown in figure 8-80. The threshold velocity for a reaction is about 55 meters per second. This value is typical of TNT bonded cast explosives and higher than most plastic bound explosives. On the other hand, reaction levels are moderately high at relatively low velocities and on occasion are considerably higher. 75/25 Cyclotol is considered relatively difficult to ignite by mechanical means but capable of a large reaction once ignited.

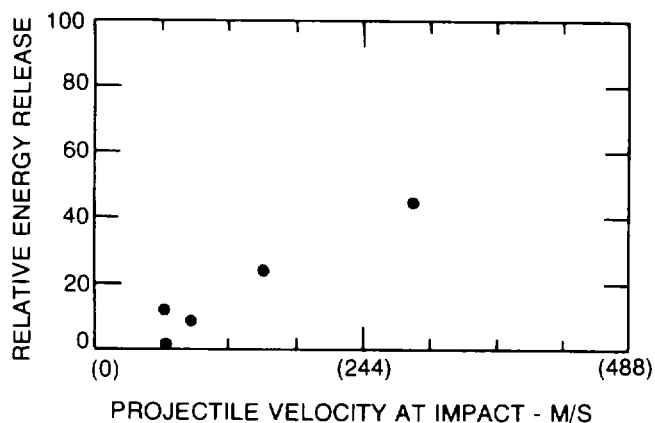

Figure 8-80. Susan test results for 75/25 cyclotol.

(h) Grade A composition B with a density of 1.713 grams per cubic centimeter and 64

percent RDX by weight has a detonation velocity of 8,018 meters per second and a detonation pressure of 292.2 kilobars. Cyclotol with 77 percent RDX by weight with a density of 1.743 grams per cubic centimeter has a detonation pressure of 312.5 kilobars.

(i) Storage of composition B at 75°C for one month causes no decrease in stability. Storage at 65°C for over one year causes no change in acidity, sensitivity to impact, or brisance. However, five months of such storage causes slight exudation. If the composition B is made from TNT which has a freezing point of 80.710C, slight exudation occurs at a storage temperature of 710C. Composition B, therefore, is of a high order of chemical stability but should not be stored at too elevated a temperature because of physical instability at such temperatures. Composition B reacts slightly with rust at 100°C. At ordinary temperature, dry composition B causes very slight corrosion of copper and brass but does not affect aluminum, mild steel, stainless steel, nickel, cadmium, or zinc. In the presence of 0.5 percent moisture, composition B causes some corrosion of cadmium and zinc also.

(j) The RDX content of composition B can be determined by extracting a weighed sample with benzene saturated with RDX, drying the residue, and calculating the weight of this to percentage of RDX. The desensitizer content is determined by extracting another weighed sample with acetone cooled to 5°C, drying the residue, and calculating the weight of this to percentage of desensitizer. The percentage of TNT in the composition is obtained by subtracting from 100 the sum of the percentages of RDX, desensitizer, and moisture found present.

(k) Composition B2 is not a standard explosive. Differing from composition B only in the absence of wax, composition B2 has a greater density when cast and is slightly more brisant. The detonation velocity is also slightly higher. Composition B2 is distinctly more sensitive than composition B, as judged by large scale impact and rifle bullet impact tests, and is slightly more sensitive to initiation. The two compositions are of the same stability and hygroscopicity. Greater impact sensitivity makes composition B2 less suitable than composition B for use in bombs.

(1) The DTA curves for composition B and 75/25 cyclotol are shown in figures 8-81 and 8-82, respectively. The TGA curve for composition B is shown in figure 8-83.

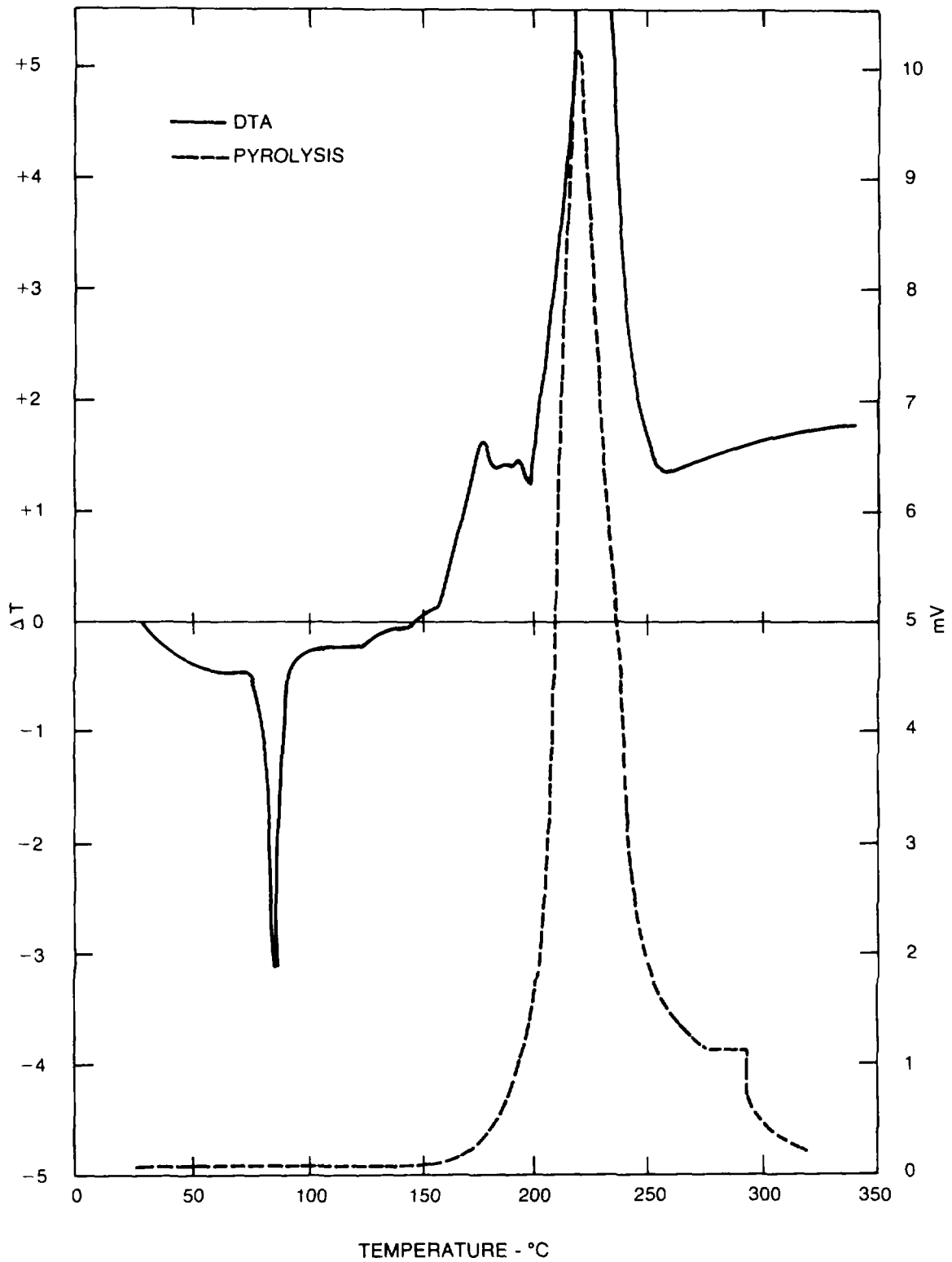

Figure 8-81. DTA curve for composition B.

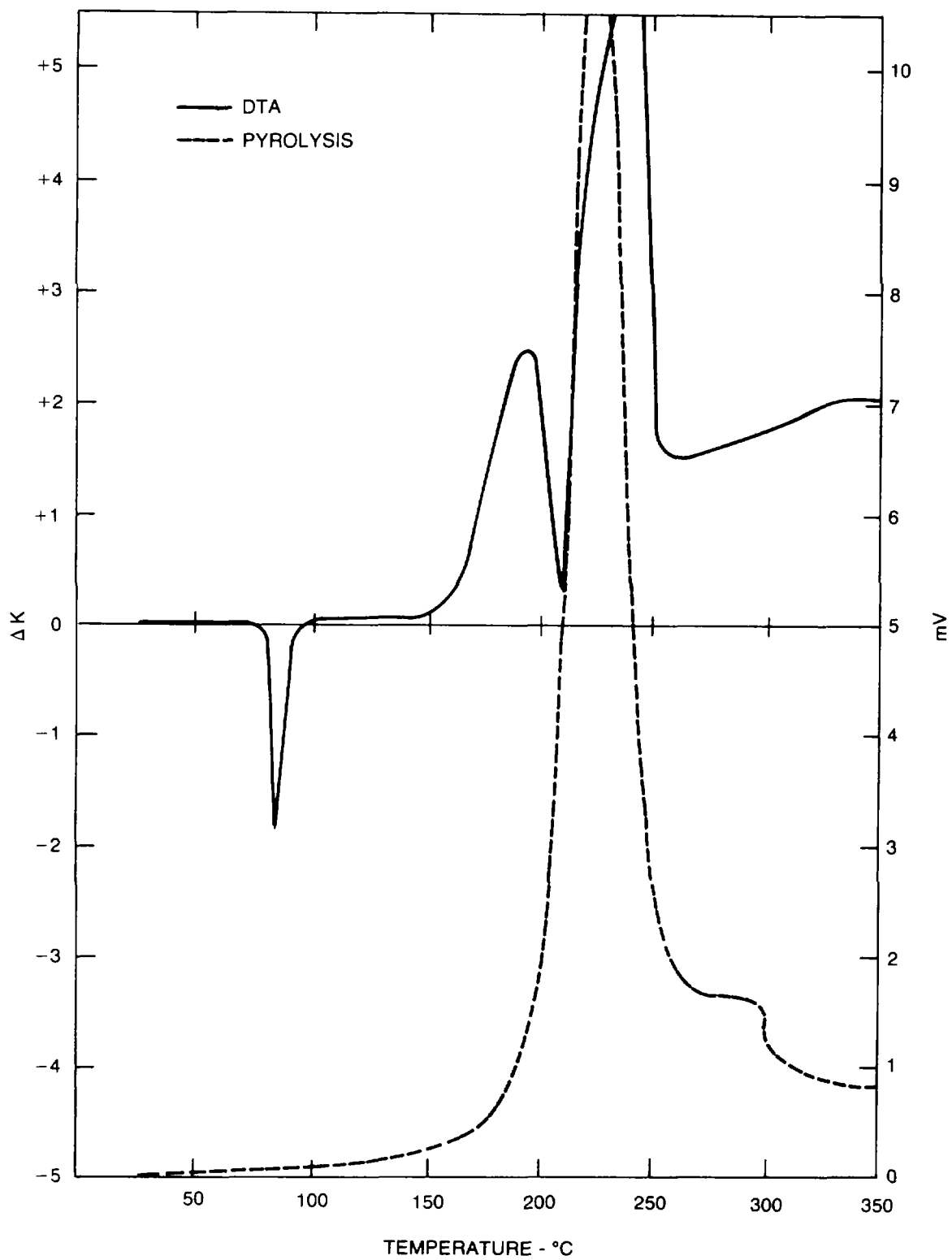

Figure 8-82. DTA curve for 75/25 cyclitol.

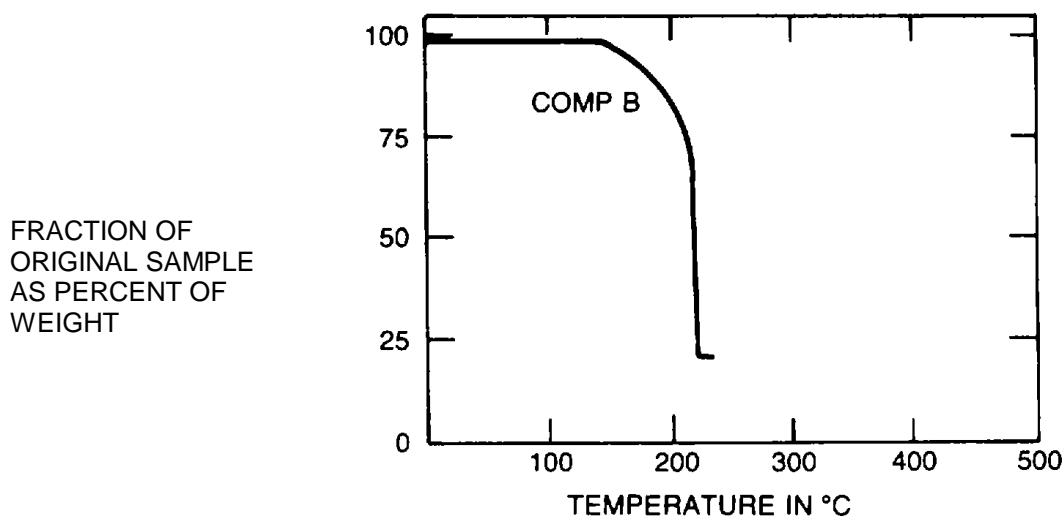

Figure 8-83. TGA curve for composition B.

(4) Composition C.

(a) During World War II, the British used a plastic demolition explosive that could be shaped by hand and had great shattering power. As standardized by the United States, this explosive was designated as composition C and contained 88.3 percent RDX and 11.7 percent of a nonexplosive oily plasticizer. Included in the plasticizer was 0.6 percent lecithin, which helped to prevent the formation of large crystals of RDX which would increase the sensitivity of the composition. Composition C was plastic from 0° to 40°C, but became brittle and less sensitive below 0°C and tended to become gummy and exude oil at temperatures above 40°C. Composition C was replaced by composition C2 which contained 80 percent RDX and 20 percent explosive plasticizer. This explosive plasticizer was composed of mononitrotoluene, a liquid mixture of dinitrotoluenes, TNT, nitrocellulose, and dimethylformamide. Composition C2 remained plastic from -30° to 52°C, but became less plastic in hot storage because of evaporation of volatile matter. Composition C2 has been replaced by composition C3, which contains 77 ± 2 percent RDX and 23 ± 2 percent explosive plasticizer. The plasticizer contains mononitrotoluene, a liquid mixture of dinitrotoluenes, TNT, tetryl, and nitrocellulose. It is a yellowish, puttylike solid that has a density of 1.60 and is soluble in acetone.

(b) In the manufacture of composition C3, the mixed plasticizing agent is placed in a steam jacketed, melting kettle equipped with a stirrer and heated to nearly 100°C. Water wet RDX is added slowly, and heating and stirring are continued until a uniform mixture has been obtained and all the water has been driven off. The mixture then is cooled while being agitated.

(c) One grade of composition C3 is manufactured. This grade includes two classes that differ only in acidity. Both class A and B material is used for the manufacture of demolition blocks, and class

B explosive is also used in the loading of ammunition in which lower acidity is desirable. The requirements applicable to composition C3 are as follows:

Composition:

RDX plus nitrocellulose, 78.0 ± 2.0 percent.

Plasticizer minus nitrocellulose, 22.0 ± 2.0 percent.

Moisture:

Maximum, 0.25 percent.

Acetone insoluble material:

Maximum, 0.15 percent.

Inorganic acetone insoluble material:

Maximum, 0.05 percent.

Grit:

Maximum particles per 50 gram sample

Retained on No. 40 sieve, none.

Retained on No. 60 sieve, 5.

Plasticity:

Minimum extension in length at 250 to 30°C, 90 percent.

Acidity:

Class A maximum, 0.064 percent

Class B maximum, 0.05 percent

(d) Composition C3 is of the same sensitivity to impact as TNT and is not exploded in the pendulum friction test. The rifle bullet impact test produces partial explosions in 40 percent of the trials, which indicates greater sensitivity than that of TNT but much less sensitivity than that of RDX. The five second explosion temperature test value, 280°C, is only slightly greater than that of TNT. Composition C3 is less sensitive to initiation than TNT, requiring a minimum detonating charge of 0.08 gram of tetryl or 0.20 gram of lead azide in the sand test. Storage for four months at 65°C in an atmosphere of 95 percent relative humidity does not impair the sensitivity to initiation. In the booster sensitivity test 50 percent detonations are produced by 100 grams of tetryl separated from pressed composition C3 with a density of 1.62 grams per cubic centimeter by acrawax B pellets 3.45 centimeters thick.

(e) The chemical stability of composition C3 is acceptable, but the physical stability is not entirely satisfactory. The results of the 120°C heat test are: 3.20 percent loss in the first 48 hours, 1.63 percent in the second 48 hours, and no explosions in 100 hours. Composition C3 is volatile to the extent of a 1.15 percent weight loss when exposed to air at 25°C for five days, and hygroscopic to the extent of 2.4 percent

when exposed to air with 90 percent relative humidity at 30°C. Tests have shown composition C3 to be of unimpaired brisance after immersion in water for 24 hours. Storage at 77°C causes considerable exudation. In vacuum stability tests at 100°C and 120°C for 48 hours, 1.21 and 11 + cubic centimeters of gas are evolved, respectively. Figure 8-84 shows the DTA curve for composition C3.

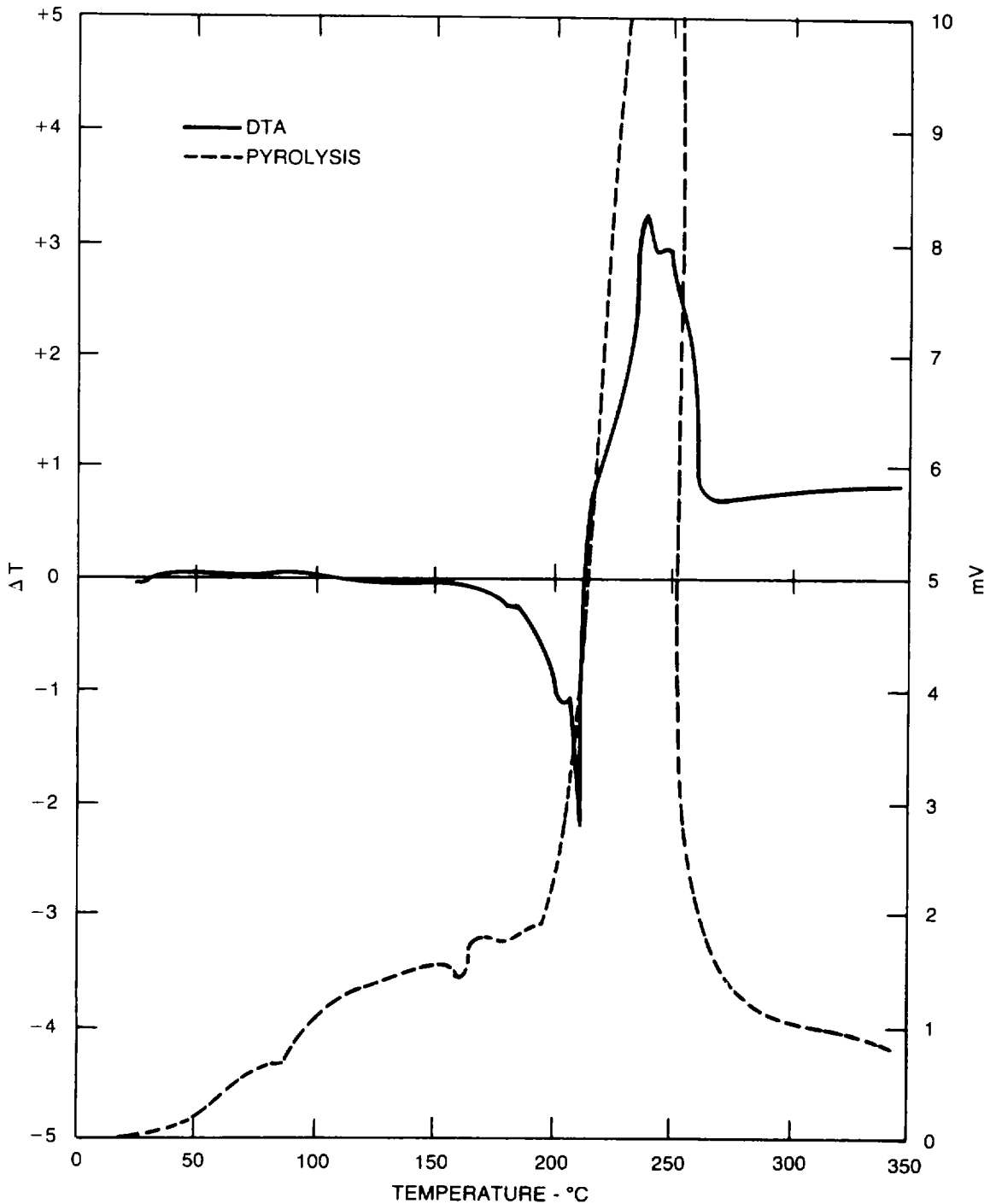

Figure 8-84. DTA curve for composition C3.

(f) In an air blast the peak pressure is 105 percent of TNT and the impulse is 109 percent of TNT.

(g) Composition C3 hardens at 29°C and has undesirable volatility and hygroscopicity characteristics, so composition C4 has been developed. The ingredients of the three classes of composition C4 are:

- Class I: 61 percent RDX class A or B, type A or B
30 percent RDX class E, type A or B
9 percent polyisobutylene
- Class II: 92 percent RDX class H, type A or B
9 percent polyisobutylene
- Class IV: 89.9-1 percent RDX
10 +1 percent polyisobutylene
0.2+0.02 percent dye composition
which consists of:
90 percent lead chromate
10 percent lamp black

Composition C4 is a pufflike material of dirty white to light brown color. The theoretical maximum density of

the mixture is 1.75 grams per cubic centimeter with a nominal density of 1.72 grams per cubic centimeter. The heat of formation is -32.9 to -33.3 calories per gram. The maximum heat of detonation with liquid water is 1.59 kilocalories per gram and with gaseous water 1.40 kilocalories per gram. Composition C4 remains plastic between -57°C and +77°C with no exudation in this temperature range. This explosive is considered a very satisfactory demolition explosive and has almost entirely replaced all the other composition C explosives.

(h) Composition C4 is manufactured by placing the water wet RDX in a stainless steel mixing kettle and adding the plastic binder. The mass is blended by tumbling the kettle until a homogeneous mixture is obtained. The resulting dough is then dried in trays by forced air at 50°C to 60°C. About 16 hours of drying are required to reduce the moisture content to below 0.25 percent.

(i) The detonation characteristics of the composition C explosives are listed in table 8-68. The detonation pressure is 257 kilobars for composition C4 with a density of 1.58 grams per cubic centimeter.

Table 8-68. Detonation Characteristics of Composition C Explosives

Test	Characteristics as a percentage of TNT			
	C	C2	C3	C4
Sand test	108	99	112	116
Plate dent test	112	111	114-118	115-130
Fragmentation test	-	-	113	-
Detonation velocity in meters per second	7,400	7,800	7,625	8,040
Trauzl test	126	-	117	-
Ballistic mortar test	125	126-143	126	130

(j) Impact tests indicate composition C4 is less sensitive than composition C3. The rifle bullet test results, with only 20 percent of the vials burning, also indicate less sensitivity. Composition C4 is unaffected in the pendulum friction test and has a five second explosion temperature of 263°C to 290°C. The minimum initiating charge required is 0.20 grams of lead azide or 0.10 grams of tetryl.

(k) Composition C4 is more stable than composition C3. The results of 100°C heat test are: 0.13 percent loss in the first 48 hours, no loss in the second 48 hours, and no explosions in 100 hours. The vacuum stability test at 100°C yields 0.20 cubic centimeters of gas in 40 hours. Composition C4 is essentially nonhygroscopic.

(5) Composition CH6.

(a) CH6 is an explosive mixture containing:

- 97.50±0.50 percent RDX
- 1.50+0.15 percent calcium stearate
- 0.50±0.10 percent graphite
- 0.50+0.10 percent polyisobutylene

The primary use of CH6 is in boosters and leads. When compared with tetryl, the material withstands higher temperature before cook off and has higher output yield, yet matches the sensitivity of tetryl. CH6 is pelletized at a density of 1.61 grams per cubic centimeter but the normal loading density is approximately 1.55 grams per cubic centimeter.

(b) In the sand test, CH6 crushes 61.3 grams of sand which indicates a brisance of 128 percent of TNT. The velocity of detonation is 8,223 meters per second.

(6) Ednatols.

(a) Ednatols are mixtures of haleite (ethylene dinitramine) and TNT. The most used haleite/TNT portions are 60/40, 55/45, and 50/50. Ednatols are yellowish, uniform blends with a melting point of 80°C. The eutectic temperature is about 80°C. In an extrudation test at 65°C there was no extrudate. Ednatols are considered satisfactory for bursting charges in ammunition. All of the following data in the discussion of the properties of ednatol refer to the 55/45 mixture. 55/45 Ednatol has an oxygen balance to carbon dioxide of -51 percent and to carbon monoxide of -17 percent. The density of the cast explosive is 1.62 grams per cubic centimeter, which is four percent greater than that of cast TNT or haleite pressed under 206,850 kilopascals (30,000 pounds per square inch).

(b) Ednatol is manufactured by heating TNT to about 105° in a steam jacketed melting kettle equipped with a stirrer. Wet haleite is added slowly with agitation to the molten TNT. After the haleite has been added, heating and stirring are continued until all the moisture has been driven off. The mixture is then cooled to about 85°C while being agitated, and loaded by pouring. Like TNT, ednatol undergoes some contraction in volume upon solidification.

(c) The sensitivity of ednatol, 95 centimeters with a two kilogram weight, is between the sensitivity of haleite and TNT. Ednatol is unaffected by either the steel or fiber shoe in the pendulum friction test. The rifle bullet impact test produces ignitions in seven percent of the trials with no detonations. The explosion temperature test value, 190°C, is the same as for haleite. This value is lower than the values for all of the other noninitiating high explosives. As might be expected, ednatol is more sensitive than TNT but less sensitive than haleite to initiation. The minimum detonating charge of mercury fulminate is 0.22 grams to 0.23 grams. In the booster sensitivity test using a 100 gram tetryl pellet, the 50 percent detonation point with acrawax B was 325 centimeters (1.28 inches).

(d) The sand test indicates ednatol is 112 percent as brisant as TNT. The plate dent test also indicates a brisance of 112 percent of TNT. The fragmentation test indicates a brisance of 118 percent of TNT, with fragment velocities of 832 kilometers per second at 2.74 meters and 741 kilometers per second at 7.77 meters. The velocity of detonation for a one inch diameter, unconfined, cast charge is 7,340 meters per second, 106 percent of TNT. As measured by the ballistic pendulum test and the Trauzl test, ednatol is 119 percent and 120 percent as powerful as TNT.

(e) In the 100°C heat test, a loss of 0.2 percent is reported in the first 48 hours and 0.1 percent in the second 48 hours with no explosions in 100 hours. In the vacuum stability test at 100°C one cubic centimeter of gas is evolved and at 120°C more than 11 cubic centimeters of gas are evolved. Dry ednatol has no effect on brass, aluminum, steels, cadmium, and nickel but causes very slight corrosion of copper, magnesium, and aluminum-magnesium alloys. Wet ednatol has no effect on stainless steel, but causes slight corrosion of aluminum and considerable corrosion of copper, brass, magnesium, magnesium-aluminum alloys, and mild steels. Ednatols are essentially nonhygroscopic when exposed to humid air.

(f) In an air blast the peak pressure is 108 percent of TNT, the impulse is 110 percent of TNT, and the energy is 108 percent of TNT. In an underwater blast, the energy is 113 percent of TNT. The shaped charge effectiveness is about 120 percent of TNT.

(g) The composition of ednatols can be determined by extracting a weighed sample with cold ether saturated with haleite and drying and weighing the residue. The weight of residue and loss in weight are calculated to percent of haleite and TNT, respectively.

(7) LX-14.

(a) LX-14 is an explosive which consists of 95.5 percent HMX and 4.5 percent estane 5702-F1. The mixture is a white solid with violet spots. LX-14 has a theoretical maximum density of 1.849 grams per cubic centimeter, a nominal density of 1.83 grams per cubic centimeter, and a melting point of greater than 270°C, with decomposition. The heat of formation is 1.50 kilocalories per mole. The calculated heats of detonation are 1.58 kilocalories per gram with liquid water and 1.43 kilocalories per gram with gaseous water. At a density of 1.835 grams per cubic centimeter the detonation velocity is 8,830 meters per second.

(b) As shown in figure 8-85, LX-14 is moderately easy to ignite in the Susan test, requiring an impact velocity of about 48 meters per second. Nosecap deformation is generally greater than 25 millimeters before ignition is observed. Reaction levels are large and somewhat erratic once the threshold velocity is exceeded. This data indicates that accidental, mechanical ignition of LX-14 has a moderately low probability of building into a violent reaction or detonation where there is little or no confinement. Figure 8-86 shows the DTA curve for LX-14.

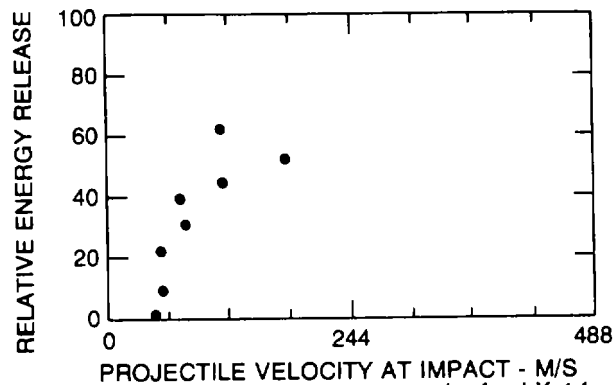

Figure 8-85. Susan test results for LX-74.

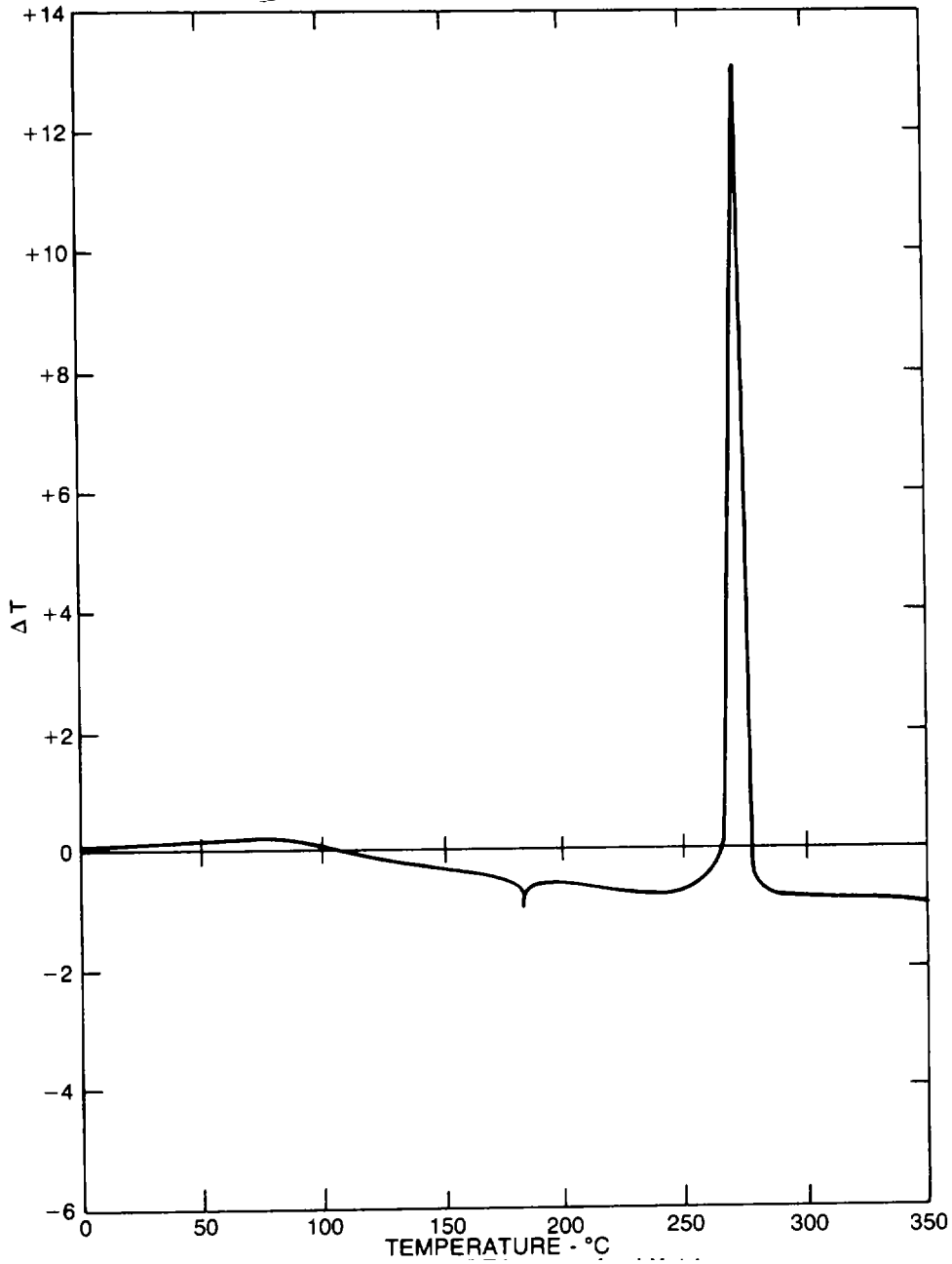

Figure 8-86. DTA curve for LX-14.

(8) Octols.

(a) Octols are mixtures of HMX and TNT. The properties of the two most commonly used octols are summarized in table 8-69.

Table 8-69. Properties of Octols

	Type I	Type II
Percent HMX	75 ±2.0	70±2.0
Percent TNT	25 ±2.0	30±2.0
Density in grams per cubic centimeter:		
Theoretical maximum	1.832-1.843	1.819-1.822
Open melt cast	1.800	1.790
Vacuum melt cast	1.801-1.825	1.805-1.810
Calculated heat of detonation in calories per gram:		
With liquid water	1,570	-
With gaseous water	1,430	-
Heat of combustion in calories per gram	2,676	2,722
Heat of fusion in kilocalories per mole	2.57	-
Specific heat in calories per gram per degree centigrade (76,9/23.1 HMX/TNT):		
at-79°C	0.200	-
-80°C < t <80°C	0.240	-
33°C < t <74°C	0.245	-
90°C < t < 150°C	0.323	-
Temperature of solid slurry phase change °C	79	79
Latent heat of solid to slurry phase change in calories per gram	5.87	7.05
Vapor pressure at 100°C in torr	0.1	-
Impact sensitivity (Picatinny Arsenal Apparatus):		
inches	17	18
Sample weight in milligrams	25	26
inches	15	19
Sample weight in milligrams	19	20
Friction pendulum:		
Steel shoe	Unaffected	Unaffected
Fiber shoe	Unaffected	Unaffected
Autoignition temperature, °C	100	108
Explosion temperature, °C:	288	289
Seconds 0.1 (no cap used)	-	-
Seconds 1	-	-
Seconds 5 (flames erratically)	350	335
Sensitivity to initiation: (minimum detonating charge lead azide in grams)	0.3	0.3

Table 8-69. Properties of Octols (Cont)

	Type I	Type II
Sensitivity to setback pressure in kilopascals at 71°C		
Probability of reaction:		
0.1 percent	655,025	551,600
50 percent	820,505	820,505
99.9 percent	1,027,355	1,213,520
0 percent	524,020	634,340
Pit fragmentation (105mm MI HE projectile)	Number of fragments	Number of fragments
1/2-2 grains	1,611	1,297
2-5 grains	777	665
5-10 grains	535	497
10-25 grains	719	661
25-50 grains	480	471
50-75 grains	246	247
75-150 grains	339	322
150-750 grains	293	295
750-2,500 grains	8	12
Detonation rate (no confinement-cast) in meters per second		
Charge density in grams per cubic centimeter	1.81	1.80
Charge dimensions in centimeters:		
1.27 x 1.27 x 15.24	8,643	8,377
2.54 x 2.54 x 15.24	8,328	8,241
3.81 x 5.08 x 15.24	8,396	8,305
8,364	8,310	
Vacuum stability (milliliters of gas per five grams of sample per 40 hours)		
at 120°C	0.39, 0.65	0.37, 0.76
at 130°C	1.13	0.97
at 140°C	2.66	1.50
at 150°C	11	5.10
at 160°C	11	11
-	-	
Air blast		
Weight of charge, 3,022 grams		
Distance from charge, 3,048 centimeters		
Overpressure, kilopascals	258.6	261.3
Impulse, kilopascal milliseconds	124.8	146.2
Distance from charge, 457.2 centimeters		
Overpressure kilopascals	90.3	100.6
Impulse, kilopascal milliseconds	86.2	106.9
Distance from charge, 609.6 centimeters		
Overpressure, kilopascals	48.9	46.2
Impulse, kilopascal milliseconds	62.7	77.2

(b) Octol is used as an oil well formation agent and in fragmentation and shaped charges. In fragmentation tests using a 105 millimeter M1 shell, 15 percent more fragments are produced and the average velocity of the fragments is 100 meters per second faster than with a similar shell loaded with composition B. This improvement is attributed to both the higher rate of detonation of octol and the greater density of octol which permits a greater weight of explosive in the same volume. Table 8-70 compares the performance of TNT, composition B, and octol in producing craters in a 105 millimeter shaped charge shell.

Table 8-70. Crater Volume in Mild Steel Targets

Depth of penetration in centimeters	Volume in cubic centimeters		
	TNT	Composition B	Octol
4	23.8	33.1	37.0
8	36.2	49.7	57.4
12	43.2	61.4	68.9
16	49.1	69.2	78.7
20	53.0	75.1	85.0
24	56.2	79.4	89.9
28	58.6	83.0	94.0
32	61.8	86.2	98.1
36	64.3	89.3	101.8
40	-	92.3	105.3
44	-	-	110.4

(c) The gap test results for 75/25 octol are given in table 8-71.

(d) As shown in figure 8-87, 75/25 octol has both good and bad properties. The threshold velocity for reaction is about 55 meters per second which is typical of TNT bonded cast explosives. On the other hand reaction levels become moderately high at relatively low velocity. The variability of results is less than that observed with 75/25 octol. This data indicates 75/25 octol is rather difficult to ignite accidentally by mechanical means but capable of a large reaction once ignited under some conditions.

(e) In the manufacture of octols, TNT is melted in a steam jacketed kettle equipped with an agitator. The temperature of the TNT is maintained at about 100°C and water wet HMX is added slowly. Stirring is continued until the water is driven off. The kettle temperature is then reduced until a viscosity suitable for casting is obtained. The viscosity of the slurry has a strong dependence on the particle size distribution and polymorphic variety of HMX used. In order for the slurry to have an efflux time of less than 15 seconds the solid HMX must consist of the beta polymorph having particle diameters in the range of 500 to 800 microns. Even when octol is cast at a temperature of less than 90°C, there is a large amount of settling of HMX crystals while the charge is still molten. This can lead to erratic performance of the ammunition loaded. Several methods to prevent the settling are being considered. Casting temperature is kept as low as possible to prevent air entrapment in the cast. Figure 8-88 shows the DTA curve for 75/25 octol.

Table 8-71. Gap Test for 75/25 Octol

	Density	Percent voids	Sensitivity in millimeters
NSWC small scale gap test	1.829	0	4.88
	1.541	15.8	10.90
LANL small scale gap test	1.810	1.1	0.56 - 0.71
LANL large scale gap test			
regular HMX	1.822 (cast)	0.7	49.45
large crystal HMX	1.815 (cast)	1.4	47.32
vacuum cast	1.795	2.0	43.56

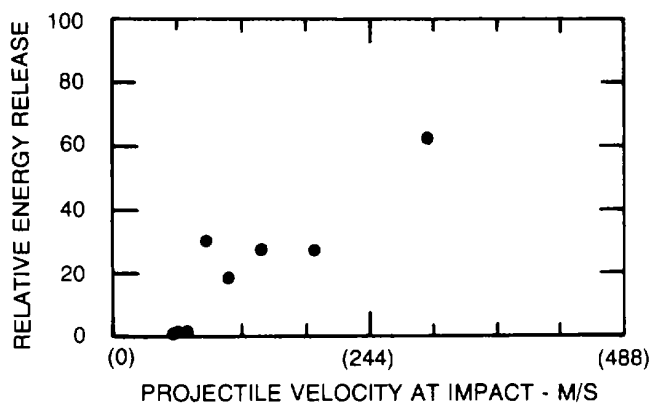

Figure 8-87. Susan test results for 75/25 octol.

(9) Pentolite.

(a) Pentolites are castable explosive mixtures containing PETN and TNT. The most commonly used blend consists of 50/50 PETN/TNT. Other blends such as 75/25, 40/60, 30/70, and 10/90 have been occasionally employed but the 50/50 blend is superior in the characteristics of sensitivity to initiation, brisance, and suitability for melt loading. 87 percent TNT and 13 percent PETN form a eutectic with a freezing point of 76.7°C. Cast 50/50 pentolite, therefore, consists of 42.2 percent PETN, and 57.8 percent of the eutectic mixture. 50/50 Pentolite has an oxygen balance to C02 of -42 percent, a heat of combustion of 1.549 kilocalories per gram, and a heat of formation of -23.4 to -24.3 kilocalories per gram. The heat of detonation with liquid water has been experimentally determined as 1.23 kilocalories per gram and the maximum calculated value is 1.53 kilocalories per gram. The heat of detonation with gaseous water has been experimentally determined as 1.16 kilocalories per gram and the maximum calculated value is 1.40 kilocalories per gram. The cast density of pentolites does not vary appreciably with blend composition. 50/50 Pentolite has a cast density of 1.63 to 1.67 grams per cubic centimeter while 10/90 pentolite has a cast density of 1.60 grams per cubic centimeter. The density of pressed pentolite is between 1.60 and 1.65 grams per cubic centimeter. Since pentolites are blends they are soluble in the same solvents as their constituent ingredients.

(b) Pentolite is manufactured by either of two methods. In the more modern, slurry method, the PETN is suspended by agitation in water heated above 80°C. TNT is then added. The temperature of the water causes the TNT to melt and coat the particles of PETN. The slurry is then cooled with rapid agitation, causing the TNT to solidify. The granules then are separated on a filter or in a centrifugal wringer and dried at a temperature below 75°C. In the coprecipitation method, the PETN and TNT are dissolved separately in acetone, the TM 91300-214 solutions are mixed and filtered, and

the two explosives are precipitated simultaneously by pouring the solution into water with vigorous agitation. The precipitated solid is then separated and dried. The slurry method permits better particle size control than the coprecipitation method. Acetone is used in the slurry method for obtaining PETN of the desired particle size, but less acetone is used than in the coprecipitation method. The slurry method also takes less time per production cycle. Casting is usually accomplished at about 90°C. Constant stirring is required to keep the PETN suspended as only about 20 percent of the PETN dissolves at that temperature. Small elongated crystals are desirable for this operation to minimize settling of the PETN and prevent the production of nonuniform charges. At 90°C to 94°C PETN crystals retain their original shape characteristics since very little solution occurs. These crystals are enclosed by crystalline TNT. Added wax causes no obvious change in microstructure.

(c) Two grades of pentolite are used for military purposes. These differ only in that grade II material complies with a bulk density requirement. Grade I is used for melt loading, while grade II is used in the manufacture of pellets and the press loading of ammunition. The requirements are:

Volatile matter	Maximum, 0.5 percent
Composition	PETN, 50±2 percent TNT, 50±2 percent
Total acetone insoluble	Maximum, 0.04 percent
Inorganic acetone insoluble	Maximum, 0.02 percent
Grit	None
Acidity or alkalinity	Maximum, 0.005 percent
PETN granulation applicable to pentolite manufactured by the coprecipitation method	
Through sieve number	30 200
Percent, minimum	95 0
Percent, maximum	- 30
100°C vacuum stability test	Maximum 5 milliliters of gas
Bulk density	Grade 11, 0.70-0.10 gram per milliliter

(d) The Picatinny Arsenal impact apparatus and the Bureau of Mines apparatus yield conflicting results; 12 inches and 34 centimeters, respectively. The rifle bullet impact test confirms the more sensitive test result. The five second explosion temperature test result is essentially that of PETN. In the pendulum friction test pentolite is unaffected. The minimum detonating charges of lead azide and mercury fulminate required for pentolite are intermediate between those for PETN and TNT and are very close to that of tetryl. The gap test results are given in table 8-72.

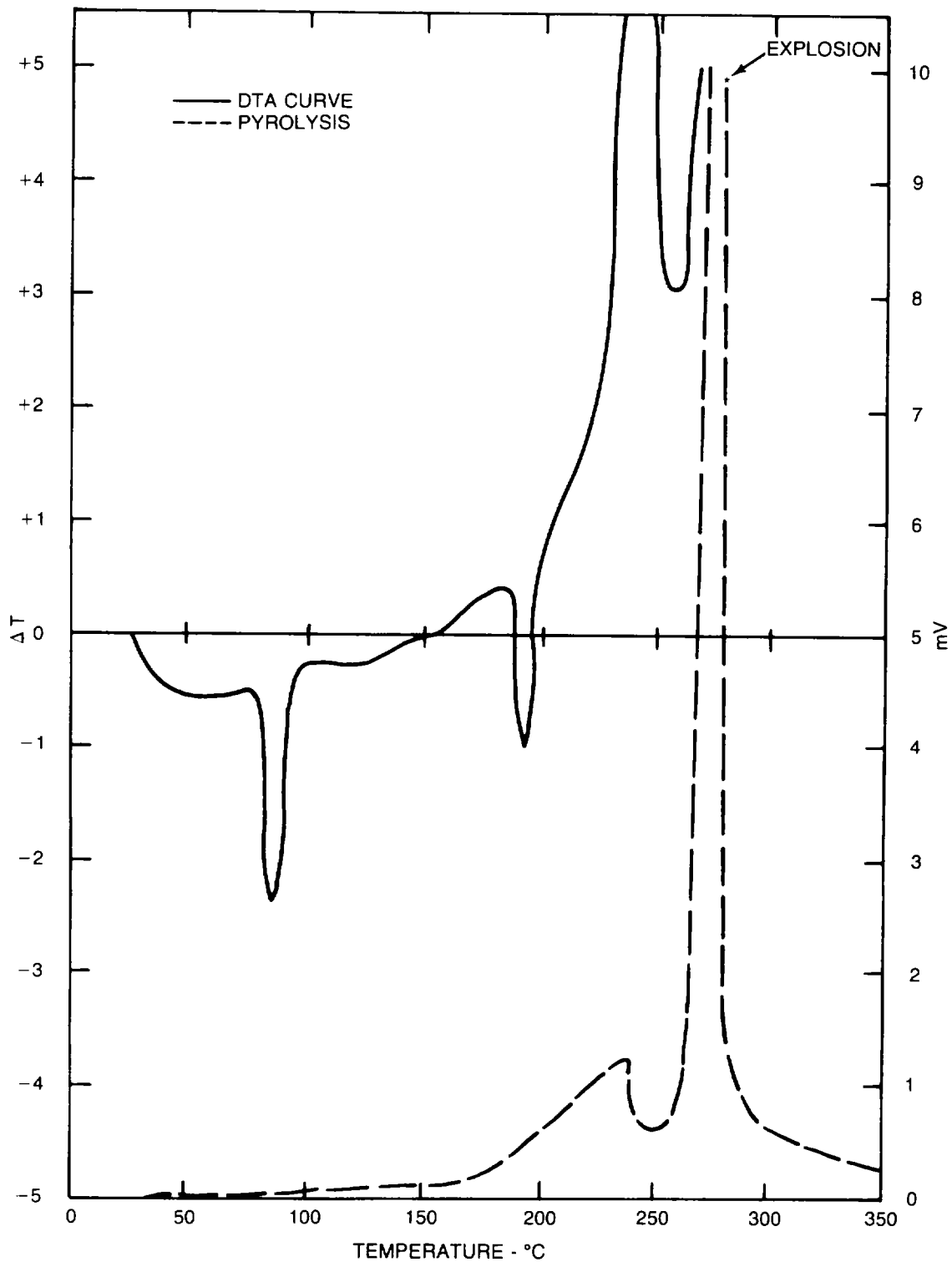

Figure 8-88. DTA curve for 75/25 octol.

Table 8-72. Gap Test Results for 50/50 Pentolite

	Density	Percent Voids	Sensitivity in millimeters
NSWC small scale gap test	1.671	2.3	10.03
	1.363	30.3	12.45
LANL small scale gap test	1.700 (cast)	0.6	0.76-0.97
	1.676 (hot pressed)	2.0	3.12
	0.75	56.1	4.80
LANL large scale gap test	1.702	0.8	64.74
	1.635	4.4	68.66

The presence of rust or grit increases the sensitivity of pentolite. A mixture of equal weights of pentolite and dry rust has an impact test value of 21 centimeters compared with 32 centimeters for the pentolite used to make the mixture.

(e) Sand test shows 50/50 pentolite to be as brisant as tetryl and 114 percent as brisant as TNT.

Fragmentation tests of shell charges, however, show pentolite to be 13 percent as brisant as TNT and plate dent tests indicate the ratio to be 126 percent. The approximate velocity of detonation as a function of packing density is given by the equation:

$$D = 5480 + 3100(p - 1)$$

where D is in meters per second and p, the density, is in grams per cubic centimeter. This ideal velocity of detonation is applicable to charges with a diameter of one inch. The variation in detonation velocity as a function of temperature is given by the equation:

$$D - D_0 = (-0.4 \times 10^{-3})(T - T_0)$$

where T is in degrees centigrade and D is in millimeters per microsecond. D_0 is the initial detonation velocity at temperature T_0 , and D is the detonation velocity at temperature T. The Chapman-Jouquet detonation pressure is 232 to 255 kilobars. In deflagration to detonation transfer studies with pentolite that is heavily confined and ignited by a hot wire, a low velocity detonation regime precedes steady state detonation for 30 to 80 microseconds. Compression waves precede the burning front in this predetonation region and appear to coalesce into a shock front. The Trauzl test indicates 50/50 pentolite is 122 percent as powerful as TNT while the ballistic mortar test indicates a power of 126 percent of TNT.

(f) Vacuum stability tests indicate 50/50 pentolite is slightly less stable than PETN although storage for two years at 65°C produces no excessive acidity or great deterioration of stability. 50/50 Pentolite

withstands 10 remelting operations at approximately 98°C without becoming unduly instable or unduly acid, but subsequent storage at 65°C for six months renders the sample unduly acid. Slow decomposition starts at 110°C and is followed by the main pyrolysis reactions which generate NO₂ rapidly. The rate of the pyrolysis of the mixture is faster than that of either TNT or PETN. While storage at 65°C has only a limited effect on the chemical stability of pentolite, some exudation occurs for storage temperatures above 50°C. This may be due to the formation of a eutectic mixture of TNT and impurities in PETN. One of the impurities present in PETN is dipentaerythritol hexanitrate, which melts at 73.6°C and forms a eutectic mixture with TNT that freezes at only 57.9°C.

(g) Because of the somewhat lower stability and greater sensitivity of PETN as compared with RDX, the corresponding relationship of pentolite to composition B, and the tendency of pentolite to undergo some exudation above 50°C, pentolite has generally been replaced by composition B. Figure 8-89 shows the DTA curve for pentolite.

(h) The composition of pentolite is determined by extracting a weighed sample with chloroform saturated with PETN, drying the residue, and weighing. The weight of the residue and the loss in weight are calculated to percentage of PETN and TNT, respectively.

(i) Underwater blast for pentolite with a density of 1.6 grams per cubic centimeter are given by the equations:

$$\text{Peak pressure} = 2.25 \times 10^4 (W^{1/3}/R)^{1.3} \text{ psi}$$

$$\text{Impulse} = 2.18 W^{1/3} (W^{1/3}/R)^{1.05} \text{ psi-sec}$$

$$\text{Energy} = 3.27 \times 10^3 W^{1/3} (W^{1/3}/R)^{2.12} \text{ inch lb/inch}^2$$

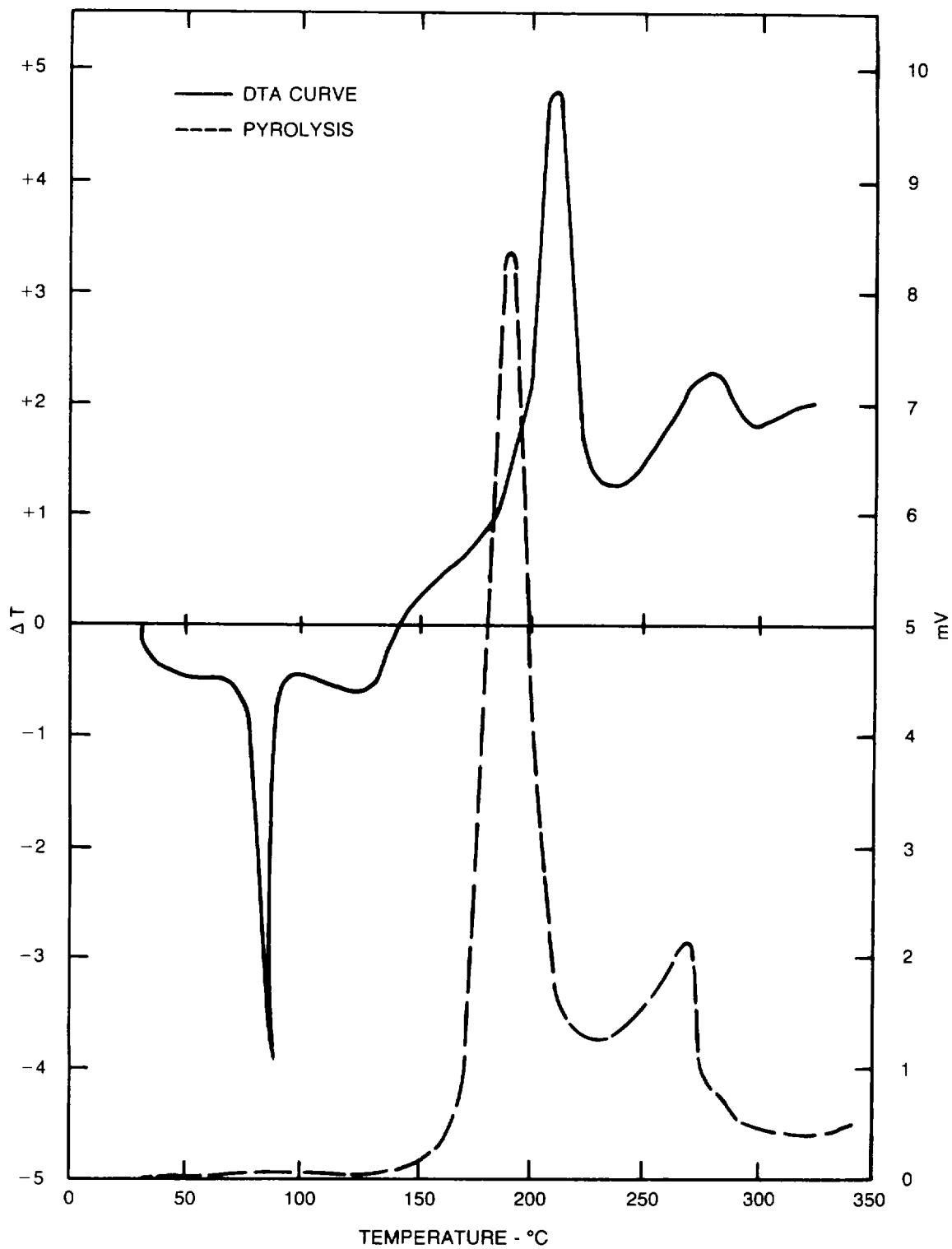

Figure 8-89. DTA curve for pentolite.

where W is the charge weight in pounds and R is the distance in feet from the center of a spherical charge.

The ratio of underwater shock energy of pentolite to the total chemical energy is 0.57 to 0.59.

(10) Picratol.

(a) Picratol is a mixture of 52 percent ammonium picrate and 48 percent TNT. Molten TNT has little or no solvent action on ammonium picrate, and consequently, cast picratol consists essentially of a physical mixture of crystals of the two explosives. The density of cast picratol is 1.61 to 1.63. This permits a weight of charge almost equal to that of ammonium picrate pressed under 68,950 to 82,740 kilopascals (10,000 to 12,000 pounds per square inch). The solubility and reactivity characteristics of picratol are essentially that of the two ingredients.

(b) Picratol is manufactured by heating TNT to above 90°C in a steam jacketed melting kettle equipped with a stirrer. The ammonium picrate is added slowly, without preheating, with continuous agitation and this is continued for a short time after all the ammonium picrate has been added. The thick slurry is allowed to cool to about 85°C before being loaded into ammunition components. Like molten TNT, picratol undergoes marked contraction in volume upon solidification. The contraction is much less than in the case of TNT.

(c) The standard small scale impact tests indicate picratol to be as sensitive to impact as TNT, rather than ammonium picrate and large scale impact tests of cast charges confirm this. Pendulum friction tests show no difference between picratol, TNT, and ammonium picrate with respect to sensitivity to friction.

When subjected to the rifle bullet impact test, picratol burns in about 40 percent of the trials but undergoes no detonation. Ammonium picrate burns in about 30 percent of the trials. The explosive temperature test value of picratol, 285°C, is less than that of ammonium picrate, 318°C, and much less than that of TNT, 475°C. Picratol is as insensitive to initiation as ammonium picrate, having a minimum detonating charge value of 0.06 gram of tetryl. The overall sensitivity of picratol, therefore, is not greater than that of TNT.

(d) 52/48 picratol is only 94 percent as brisant as TNT, as judged by the sand test, but the plate dent test indicates the two to be equally brisant, and the fragmentation of shell charges show picratol to be 102 percent as brisant as TNT. The rate of detonation of cast picratol is 101 percent that of cast TNT. Picratol and TNT are of equal power, as measured by the ballistic pendulum test, and have equal blast effects.

TM 9-1300-214 (e) The stability of picratol is very slightly less than that of either TNT or ammonium

picrate as measured by vacuum stability tests at 1000, 1200, and 150°C.

These test results may indicate slight reaction between the ammonium picrate and the molten TNT ingredients at the elevated temperatures of the tests. At ordinary temperatures, there is no evidence of such reaction and picratol appears to be of the same high order of stability as its ingredients.

(f) The composition of picratol can be determined by extracting a weighed sample with cold ether that has been saturated with ammonium picrate. The residue is dried and weighed and this and the loss in weight are calculated to percentage of ammonium picrate and TNT, respectively.

(11) Tetrytols.

(a) Tetrytols are light yellow to buff mixtures of TNT and tetryl. As is the case for tetryl, tetrytols are no longer used by the United States but are still being used by other nations including various NATO allies. Tetrytols resemble tetryl more closely than they resemble TNT.

They are more powerful but less sensitive than TNT.

Tetrytols can be cast into munitions, which is an advantage over press loading. Table 8-73 compares the physical characteristics of various tetrytol compositions.

The pressed density listed is for material that passed through a number 100 US standard sieve and was subjected to a pressure of 20,685 kilopascals (3,000 pounds per square inch). 70/30 Tetrytol is the most commonly used form and has a voidless density of 1.71 grams per cubic centimeter. All of the tetrytols are subject to exudation above 65°C. TNT and tetryl form a eutectic mixture that has a freezing point of 67.5°C. The solubility characteristics and chemical reactivity of the tetrytols are essentially those of the individual ingredients.

(b) Tetrytol is manufactured by heating TNT in a melting kettle equipped with an agitator until all the TNT is melted and the temperature of the liquid slightly exceeds 100°C. The proper amount of tetryl is then added with continued stirring. Part of the tetryl dissolves in the TNT. The temperature is then allowed to decrease until the mixture has thickened somewhat and is considered to be of the maximum viscosity suitable for pouring in the melt loading operation. The tetrytol is then poured into the ammunition component or a mold. As cast, tetrytol is a mixture of tetryl and the TNT-tetryl eutectic. The eutectic contains approximately 55 percent tetryl.

Table 8-73. General Characteristics of Tetrytols

Percentage composition by weight	Cast density in grams per cubic centimeter	Pressed density in grams per cubic centimeter	Molecular weight	Oxygen balance to CO ₂	Melting point °C	Former United States usage
80/20 Tetrytol	1.51	-	274	-52	68	not used
75/25 Tetrytol	1.59	1.34	270	-54	68	bursting charge, demolition explosive
70/30 Tetrytol	1.60	1.36	266	55	68	bursting charge, burster charge in chemical shells
65/35 Tetrytol	1.60	1.38	264	-56	68	burster charge in land mines

(c) There is no difference in the impact sensitivity of 65/35, 70/30, or 75/25 tetrytol. All are less sensitive than tetryl and more sensitive than TNT. All tetrytols are unaffected by the steel and fiber shoes in the pendulum friction test. The rifle bullet impact test, in which a 30 caliber bullet is fired into the open end of a pipe confined charge, yields the following results:

	Unaffected percentage	Partially affected percentage
80/20 Tetrytol	80	20
75/25 Tetrytol	70	30
70/30 Tetrytol	45	55
65/35 Tetrytol	90	10

In a wax gap test 75/25 tetrytol is somewhat more sensitive than composition B, but appreciably less sensitive than pentolite. The following shows the minimum priming charge required for the tetrytols.

	Grams lead azide	Grams mercury fulminate
80/20 Tetrytol	0.17	0.22
75/25 Tetrytol	0.19	0.23
70/30 Tetrytol	0.22	0.23
65/35 Tetrytol	0.23	0.23

For a priming charge of diazodinitrophenol (DDNP) the minimum charge required is 0.19 grams for pressed 75/25 tetrytol at a density of 1.4 grams per cubic centimeter and 0.31 grams for cast 75/25 tetrytol.

(d) In the plate dent test the brisance of 75/25 tetrytol at densities of 1.66 grams per cubic centimeter and 1.62 grams per cubic centimeter is 118 percent and 114 percent of TNT, respectively. 70/30 Tetrytol at 1.60

grams per cubic centimeter has a brisance of 117 percent of TNT. The sand test indicates 70/30 tetrytol is 97.5 percent and 111 percent as brisant as tetryl and TNT, respectively. The following detonation velocities were measured in one inch diameter charges without confinement. For cast 75/25 tetrytol with a density range of 1.55 to 1.60 grams per cubic centimeter and an average of 1.57 grams per cubic centimeter, the measured detonation velocities ranged from 7,290 to 7,410 meters per second with an average of 7,350 meters per second. For cast 65/35 tetrytol with a density range of 1.56 to 1.61 grams per cubic centimeter and an average of 1.58 grams per cubic centimeter, the measured detonation velocities ranged from 7,310 meters per second to 7,370 meters per second with an average of 7,340 meters per second. The ballistic mortar test indicates 75/25 and 70/30 tetrytols are 122 percent and 120 percent of TNT, respectively.

(e) 70/30 Tetrytol is slightly less stable than tetryl at 100°C and higher temperatures, as shown by vacuum stability tests. However, at 65°C and lower temperatures, samples have been stored for two years with no change in stability, acid content, sensitivity, or brisance. Although tetryl undergoes partial decomposition on melting, the melting of tetrytol does not have the same effect. Tetrytol that has been melted and solidified 12 times shows no change in freezing point, sensitivity to impact, or 100°C vacuum stability test value although the temperature was each time raised to 107°C and maintained at that value for half an hour prior to solidification by cooling. Storage at 65°C causes some separation of an oily extrudate and distortion of blocks of tetrytol, so the maximum storage temperature is less than 65°C. This low storage temperature has caused the United States to discontinue the use of tetrytol. Tetrytol

is incompatible with 3M adhesives EC8708 and EC1099. Dry tetrytol is compatible with copper, brass, aluminum, magnesium, stainless steel, mild steel coated with acid proof paint, and mild steel plated with copper, cadmium, zinc or nickel. Magnesium-aluminum alloys are slightly affected by dry tetrytol. Wet tetrytol is compatible with stainless steel and mild steel coated with acid proof black paint. Copper, brass, aluminum, magnesium, magnesium-aluminum alloy, mild steel, and mild steel plated with cadmium, copper, zinc, or nickel are slightly affected by wet tetrytol.

(f) The shaped charge effectiveness of 70/30 tetrytol at a density of 1.64 grams per cubic centimeter, as gauged in a constant volume test, is appreciably lower than composition B, octol, and composition A, when all are at roughly equivalent packing densities. 60/40 Tetrytol is as efficient a shaped charge filler as 50/50 pentolite and somewhat better than TNT. Both 75/25 and 65/35 tetrytols are approximately 1.2 to 1.25 times more effective shaped charge fillers than TNT.

(g) Determination of the composition of a sample of tetrytol can be made by treating a weighed sample with sufficient boiling carbon tetrachloride to dissolve the TNT present, cooling to 0°C, evaporating a weighed portion of the solution to dryness, and correcting for the amount of tetryl dissolved by the carbon tetrachloride at 0°C.

(12) Tritonal.

(a) Tritonal is a silvery solid that contains:

TNT	80 percent
Flaked aluminum	20 percent

Metallic aluminum is insoluble in TNT so tritonal begins to melt at the melting point of TNT. Tritonal has a heat of combustion of 4,315 calories per gram per degree centigrade at constant pressure and a thermal conductivity of 0.0011 calories per gram per degree centigrade at 0°C. These values are 120 percent and 200 percent of those for TNT. At 20°C the calculated specific heat is 0.305 calorie per gram per degree centigrade. Like TNT, tritonal undergoes considerable expansion on melting and contraction on freezing. The solubility characteristics of tritonal are essentially those of TNT. Tritonal is used as a filler in bombs and shells. The density of the cast material is 1.73 grams per cubic centimeter.

(b) The chemical reactivity of tritonal is that of TNT and aluminum. In addition in the presence of moisture, the TNT and aluminum undergo slight reaction with the evolution of gas. This is not of practical importance because of the very slight hygroscopicity of TNT and the fact that any moisture present is driven off by heat during the manufacture of tritonal.

(c) 80/20 Tritonal is manufactured from TNT and grained aluminum. The TNT and aluminum are run slowly through separate chutes into a steam heated melting kettle equipped with a stirrer which is kept in motion while the ingredients are being added. Heating and mixing are continued until all the TNT is melted, the temperature is greater than 81°C, and the fluidity of the mixture is considered satisfactory. The tritonal is then loaded by pouring into bombs, using at least the same precautions and techniques used in the melt loading of TNT.

(d) Although the pendulum friction test shows no measurable difference in sensitivity between tritonal and TNT, impact tests indicate tritonal to be somewhat more sensitive to impact than TNT and less so than tetryl. The rifle bullet impact test value for tritonal is more similar to that of tetryl than that of TNT. The explosion temperature test value of tritonal, 470°C, is almost identical with that of TNT. Liquid tritonal at 90°C is slightly more sensitive than the solid, as judged by rifle bullet impact tests. As indicated by the sand test, the minimum detonating charge of lead azide, 0.30 gram, is slightly greater than that required for TNT. Nonstandard initiation sensitivity tests with diazodinitrophenol as the initiator show tritonal and TNT to be of essentially the same sensitivity to initiation.

(e) The sand test indicates 80/20 tritonal is 108 to 114 percent as brisant as TNT. The plate dent test and the fragmentation test indicate a brisance of 93 percent and 91 percent of TNT respectively. The rate of detonation of cast tritonal is approximately 97 percent that of cast TNT. The heat of explosion of tritonal is 59 percent greater than that of TNT, but tritonal is only 124 percent as powerful as TNT, as measured by the ballistic pendulum test. The Trauzl test indicates tritonal is 153 percent as powerful as TNT.

(f) As tritonal has the same 150°C vacuum stability test value as TNT, aluminum and TNT do not react at that or lower temperatures. Tritonal, therefore, has the same stability as TNT, if free from moisture.

Deterioration in the presence of moisture is not serious, probably because the formation of a layer of oxide on the surface of the particles of aluminum prevents or retards further reaction. Tritonal, like TNT, can undergo exudation if stored at elevated temperatures, but this tendency is less than that of TNT because of the presence of 20 percent by weight of metallic particles that tend to hold oily exudate by surface tension. This prevents the oily exudate from coalescing and exuding.

(g) When tested for blast effect, tritonal has a peak pressure of 113 percent of TNT and an impulse value of 118 percent of TNT.

(h) The composition of a sample of tritonal is determined by extracting a weighed sample with benzene, drying the residue, and weighing the sample. The loss in weight represents TNT and the weight of residue represents aluminum. Each is calculated to a percentage basis.

b. Ternary Mixtures.

(1) Amatex 20.

(a) Amatex 20 consists of:

RDX	40 percent
TNT	40 percent
Ammonium nitrate	20 percent

The mixture has a nominal density of 1.61 grams per cubic centimeter and is used as a filler in ammunition items.

(b) Amatex 20 is slightly less sensitive than TNT, with impact test results of 15 to 18 inches on the Picatinny Arsenal apparatus. In the rifle bullet impact test of 100 trials, six detonated low order, three burned, and the rest are unaffected. The relative gap test value is 105 percent of TNT. The five second explosion temperature is 240°C.

(c) The detonation velocity at 1.61 grams per cubic centimeter is 6,944 meters per second, although values of 6,830 meters per second at a density of 1.68 grams per cubic centimeter have been reported. A detonation pressure of 240 kilobars has been reported for a charge with a density of 1.68 grams per cubic centimeter. The ballistic mortar test indicates amatex 20 is 110 percent as powerful as TNT. Vacuum stability tests indicate amatex 20 is a highly stable explosive.

(2) Ammonal.

(a) Ammonals are mixtures containing, as principle ingredients, ammonium nitrate and powdered aluminum incorporated with high explosives such as TNT, DNT, and RDX. Powdered carbon was also used in earlier ammonals. In the ammonals that do not contain carbon, the mixture of ammonium nitrate and high explosive detonates developing a very high temperature which causes volatilization of the aluminum powder. Secondary reactions which follow involve the oxidation of the vaporized aluminum, either by the air, if oxygen is present, or by the products formed on detonation of TNT and ammonium nitrate according to the following equations:

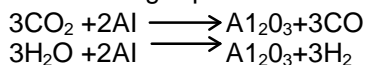

Both these reactions are highly exothermic and develop much additional heat which causes greater expansion of the gases and consequently greater blast effect.

Many different combinations of ingredients have been used, both militarily and commercially. The most recent United States military ammonal consists of 22 percent ammonium nitrate, 67 percent TNT, and 11 percent flaked aluminum. The oxygen balance of the compound is 55 percent to CO₂ and 22 percent to CO. The major use of this composition is as a projectile filler.

(b) As in the case of ammonium nitrate in amatols, the ammonium nitrate of ammonals might be hydrolyzed in the presence of moisture with the formation of ammonia but, due to the presence of aluminum, the amount of ammonia will be much greater. This amount might be as much as three times greater with ammonals than with 80/20 amatol. The ammonia reacts with TNT to form a complex addition compound which ignites at 67°C. In addition, the reaction between aluminum and moisture produces hydrogen, which is highly inflammable in oxygen or compounds containing oxygen.

(c) The general effect of incorporating aluminum in ammonium nitrate/TNT mixtures is as follows:

1. Increase in sensitivity to impact, friction, and rifle bullet impact.
2. Increase of temperatures of detonation from about 1,700°C to about 3,914°C to 4,000°C.
3. A 20 percent increase in power.
4. An increase in some cases of the total volume of gas evolved on detonation.
5. A decrease in velocity of detonation and brisance.

(d) Ammonals are manufactured by a method similar to that used for the preparation of amatols. The calculated amount of TNT is placed in a kettle that is equipped with an agitator and steam jacket.

The temperature of the kettle is raised to between 85°C and 100°C. The calculated amount of ammonium nitrate, which was previously heated to the same temperature as the contents of the kettle, is then added. Finally aluminum powder is added and the mass cooled while continuing the agitation. If the ammonal mixture contains less than 40 percent TNT, press loading is necessary. For compositions with more than 40 percent TNT, the mixture can be cast loaded.

(e) In general, ammonals are fairly insensitive and stable mixtures but are hygroscopic due to the presence of ammonium nitrate. In the presence of moisture, ammonals react with the same metals as amatols: copper, bronze, lead, and copper plated steel.

(3) High Blast Explosives.

(a) Three compositions of high blast explosives are used as shown in table 8-74.

Table 8-74. High Blast Explosives

	HBX-1	HBX-3	H-6
RDX (including nitrocellulose, calcium chloride, and calcium silicate)	40.4 ±3.0%	31.3 ±3.00%	45.1 ±3.0%
TNT	37.8 ±3.0%	29.0 ±3.0%	29.2 ±3.0%
Aluminum	17.1 ±3.0% ^o	34.8 ±3.0%	21.0 ±3.0%
Wax and lecithin	4.7 ± 1.0%	4.9 ±1.0% ^o	4.7 ± 1.0%
Oxygen balance			
to CO ₂	-68	-75	-
to CO	-35	-49	-
Density in grams per cubic centimeter:			
Theoretical maximum	1.76	1.882	-
Nominal	1.69- 1.74	1.81 - 1.86	1.75
Heat of combustion in calories per gram	3,882	4,495	-
Heat of detonation in calories per gram:			
with liquid water	1,840	2,110	-
with gaseous water	1,800	2,110	-
Impact sensitivity as a percentage of TNT	75	70	-
Rifle bullet impact sensitivity as a percentage of TNT	75	80	-
Gap test sensitivity as a percentage of TNT	80	90	-
Fragmentation test in 90-mm, HE, M71 shell, number of fragments (TNT-703)	910	476	-
Brisance by sand test as a percent of TNT	102	93.5	
Detonation velocity in meters per second at density (in grams per cubic centimeter)	7,222 1.75	6,920 1.86	7,190 1.71
Detonation pressure in kilobar			23.7
Ballistic mortar:	133% TNT	111% TNT	-
% TNT in air (shock)	121	116	-
%. TNT in air (impulse)	121	125	-
Heat test at 100°C:			
% Loss in 1st 48 hrs	0.058	0.70	-
% Loss in 2nd 48 hrs	0	0	-
Explosions in 100 hrs	None	None	-
Hygroscopicity, % loss (in 7 days at 30° and 95% relative humidity)	2.98	2.01	-

Table 8-74. High Blast Explosives (Cont)

	HBX-1	HBX-3	H-6
Blast effects:			
% TNT under water (shock)	111	101	-
% TNT under water (bubble)	145	191	-

(b) HBX explosives are prepared by melting TNT in a steam jacketed kettle equipped with a mechanical stirrer. Water wet RDX is added slowly with stirring and heating until all the water is evaporated. Powdered aluminum is added and the mixture is stirred until uniform. D2 wax and calcium chloride are then added and the mixture is cooled to a temperature suitable for casting. HBX can also be prepared by adding the calculated amount of molten TNT to molten composition B to obtain the desired proportion of RDX and TNT. Then the appropriate weights of other ingredients are added to complete the composition. D2 wax, also referred to as composition D2, consists of 84 percent paraffin wax, 14 percent nitrocellulose, and 2 percent lecithin. Figure 8-90 shows the DTA curve for H6.

(4) HMX, TNT, and aluminum mixture 3 (HTA-3).

(a) There are two types of HTA-3 as shown in table 8-75:

Table 8-75. HTA-3 Composition

	Type I	Type II
Percent HMX	49	49
Percent TNT	29	28.65
Percent aluminum	22	22
Percent calcium silicate	-	0.35

The mixture has an oxygen balance to CO₂ of -21 percent and a specific gravity of 1.90 when cast. The heat of combustion is 3,687 calories per gram and the heat of explosion is 1,190 calories per gram. The specific heat is 0.245 calories per gram per degree centigrade.

(b) To manufacture HTA-3, TNT is heated to about 100°C in a steam jacketed kettle equipped with an agitator. Water wet HMX is added slowly to the molten TNT. Stirring and heating are continued until all the water is evaporated. Aluminum powder is then added and the mixture is cooled with continued stirring. When a satisfactory viscosity is obtained the HTA-3 is cast.

(c) The impact test result on the Picatinny Arsenal apparatus is 17 inches for a 25 milligram sample. In the pendulum friction test HTA-3 is unaffected by either the steel or fiber shoe. The rifle bullet impact test indicates a relatively high sensitivity. 90 percent of the trials explode and the other 10 percent burn. HTA-3 requires a minimum detonating charge of 0.30 grams of lead azide. The five second explosion temperature is about 370°C.

(d) In the sand test, HTA-3 crushes 61.3 grams of sand indicating a brisance of 128 percent of TNT for an unconfined cast charge 2.54 centimeters in diameter. The detonation rate is 7,866 meters per second. In the 120°C vacuum stability test, 0.37 cubic centimeters of gas are evolved in 40 hours from a one gram sample.

(5) Minol-2.

(a) Minols are mixtures of TNT, ammonium nitrate, and aluminum. Minol-2 which is the type currently used, has the following composition:

TNT	40 ±3 percent
Ammonium nitrate	40 ±3 percent
Aluminum	20 ±3 percent

The explosive is a gray solid with a cast density of 1.62 to 1.74 grams per cubic centimeter. The heat of formation is 46.33 kilocalories per mole. The heat of detonation is 2.01 kilocalories per gram with liquid water and 1.86 kilocalories per gram with gaseous water. The heat of combustion is 3,160 calories per gram. At a density of 1.74 grams per cubic centimeter and a temperature of -5°C, minol-2 has a specific heat of 0.30 calories per gram per degree centigrade. Minols are used in four types of ordnance: underwater depth bombs, block buster bombs, concrete fragmentation bombs, and general purpose bombs. In underwater ordnance the confinement effects of the water somewhat offset the effects of the relatively low detonation velocity. In block buster bombs a sustained and powerful impulse is more destructive than a high peak pressure. In concrete fragmentation bombs, the high impulse will impart a satisfactory velocity to the fragments but will not pulverize the concrete.

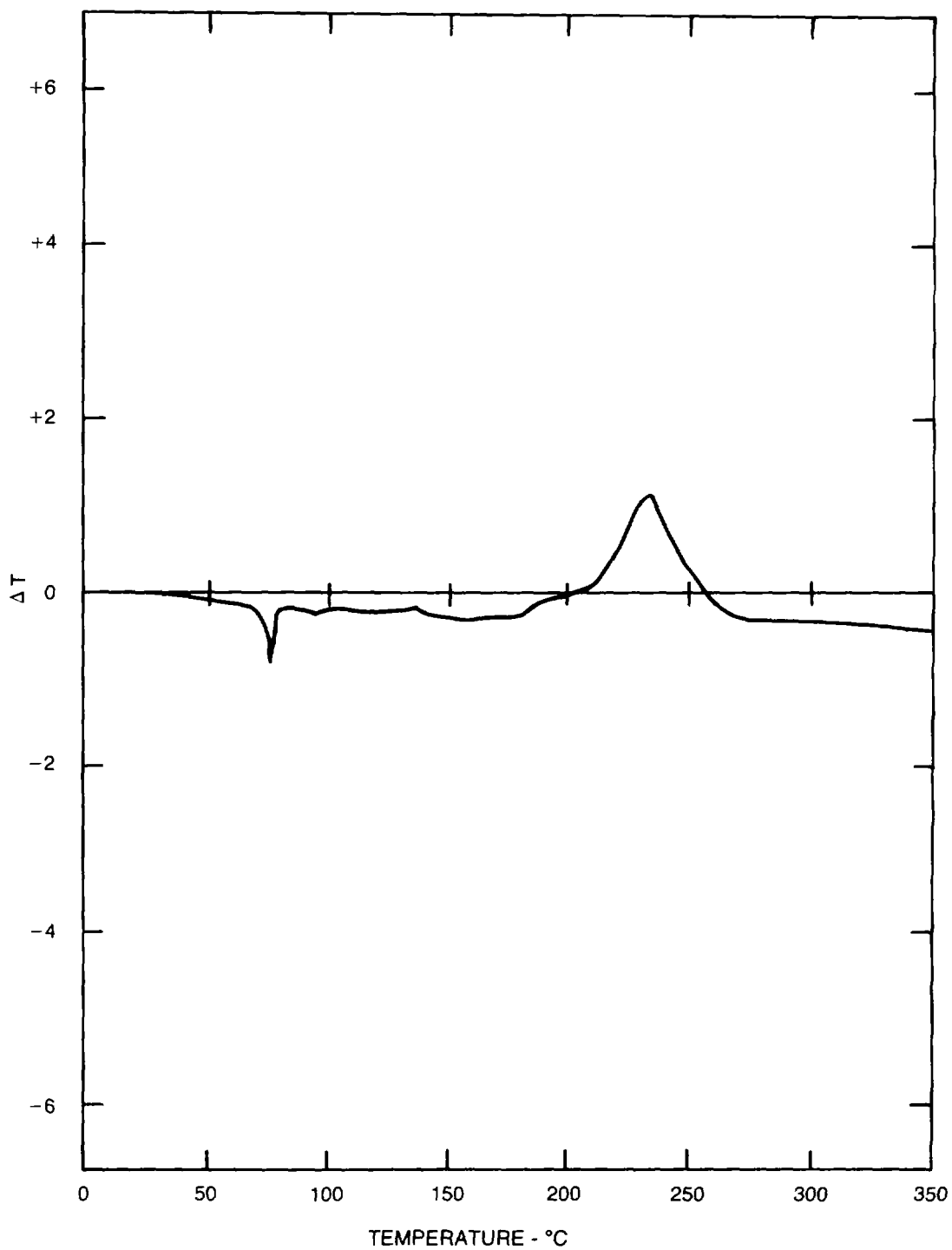

Figure 8-90. DTA curve for H6.

(b) Minols are manufactured by adding appropriate quantities of dry ammonium nitrate and aluminum powder to molten TNT at about 90°C under agitation. Originally the aluminum was in the form of a fine powder, however, such a fine degree of subdivision is not necessary. The larger aluminum particles do not cause any loss of performance and have a smaller surface area per unit volume and so reduce the reactivity of the aluminum in the mixture and increase the stability.

(c) The impact sensitivity, as measured by the Picatinny Arsenal apparatus with a 17 milligram sample, is 13 inches. Using the Bureau of Mines apparatus, with a 20 milligram sample, the drop height is 35 centimeters. In the rifle bullet test 62 percent of the trials were affected. The five second explosion temperature is 224°C to 260°C. The flammability index is 100. The 50 percent level in the booster sensitivity test is 3.71 centimeters using a 100 gram tetryl pellet and minol-2 with a density of 1.74 grams per cubic centimeter. The relative gap test value is 120 percent of TNT.

(d) In the sand test minol-2 crushes 40.5 grams of sand indicating a brisance of 86 percent of TNT. The plate dent test indicates a brisance of 66 percent of TNT. In the fragmentation test the fragment velocity is about the same as for TNT. The detonation velocity at a density of 1.62 to 1.68 grams per cubic centimeter is 5,900 meters per second and at 1.77 grams per cubic centimeter is 6,200 meters per second. The ballistic pendulum test and the Trauzl test indicate that minol-2 is 143 percent and 165 percent as powerful as TNT, respectively.

(e) In the 100°C vacuum stability test minol-2 does not evolve any gas in 48 hours, but in the 120°C test a 5.0 gram sample evolves 2.1 cubic centimeters of gas in 40 hours. When stored in munitions, minols tend to spew or ooze. The cause of this problem has not been determined at the present time. Minol-2 expands more but extrudes less than TNT or tritonal under similar temperature cycling conditions. Dry minol-2 is stable and unreactive when cycled between ambient temperature and 100°C. If the minol-2 is prepared with dry ammonium nitrate there is no phase change under 50°C. However, when ammonium nitrate that is not thoroughly dry is used, the minol-2 will exhibit a reversible phase transition beginning at 32°C, producing volume changes of about 3.8 percent. These volume changes could cause microcrystalline cracks and pores which could reduce detonation velocity and mechanical strength.

(6) Torpex.

(a) Torpex is a silvery white solid when cast. The composition of torpex is 41.6 percent RDX, 39.7 percent TNT, 18.0 percent aluminum powder, and 0.7 percent wax. The density of cast torpex is 1.82 grams per cubic centimeter. At 15°C the specific heat is 0.24 calories per gram per degree centigrade. When the explosive undergoes solidification, there is a decrease in volume of six percent. Torpex is nonhygroscopic where exposed to air of 90 percent relative humidity at 30°C. When heated, torpex undergoes partial melting near the melting point of TNT. The partially liquid explosive has viscosity values of 4.5 and 2.3 poises at 83°C and 95°C, respectively. This is approximately the viscosity of glycerin at room temperature.

(b) Torpex is manufactured by melting TNT in a steam jacketed kettle equipped with a stirrer and heating the molten TNT to approximately 100°C. RDX that is slightly wetted with water is added slowly and mixing and heating are continued until all water has been driven off. Grained aluminum is added and the mixture is stirred until uniformity is obtained. The mixture is then cooled, with continued stirring, until the viscosity is suitable for pouring. The aluminum tends to settle out of the torpex in large castings if the liquid is allowed to set too long. To prevent this, a portion of the casting is poured and allowed to cool to the point of crusting over before another layer of torpex is poured. Torpex of slightly different composition can be manufactured by melting 12.5 parts of TNT, adding 69.5 parts of composition B and, after heating and stirring, adding 18 parts of aluminum. This illustrates the fact that torpex is essentially aluminized 50/50 octol.

(c) Torpex is considerably more sensitive to impact than composition B and undergoes partial or complete explosions in all trials in the rifle bullet impact test. Torpex is more impact sensitive at higher temperatures as is indicated by the following data.

Temperature in degrees centigrade	Impact sensitivity
25	15
32	7
104	8

The five second explosion temperature test value, 260°C, is the same as that of RDX. Cast torpex is much more sensitive to initiation than cast TNT and pressed torpex is as sensitive as RDX to initiation by mercury fulminate.

(d) Sand tests indicate torpex to be 98 to 99 percent as brisant as RDX and 122 percent as brisant as TNT. As judged by plate dent test values, cast torpex is 120 percent as brisant as TNT. Fragmentation tests of shell charges indicate torpex to be 126 percent as brisant as TNT and, therefore, inferior to composition B in this respect. The rate of detonation of cast torpex is 110 percent that of TNT. The heats of combustion and explosion are 3,740 calories per gram and 1,800 calories per gram, respectively. Trauzl tests for the heat of explosion indicate torpex to be 161 to 162 percent as powerful as TNT, but the ballistic pendulum test gives torpex a superiority of only 34 percent. Torpex has a great blast effect. The following blast comparisons are relative to TNT as 100:

	Air	Air, confined	Underwater
Peak pressure	122	-	116
Impulse	125	116	127
Energy	146	-	153

(e) Vacuum stability tests show torpex to be of the same order of stability as composition B. Storage at 75°C for one month or 65°C for 13 months has no effect on the stability of torpex. In the 100°C heat test there is no weight loss in the first 48 hours, 0.10 percent weight loss in the second 48 hours, and there is no explosion in 100 hours. Torpex, therefore, has high stability. However, moisture reacts with the ingredients in torpex causing the evolution of gas which can cause rupture of the ammunition component or cause an increase in the sensitivity of torpex to shock. For this reason all moisture must be removed during manufacture.

(f) The composition of torpex can be determined by extracting a weighed sample with cold benzene or toluene that has been saturated with RDX. The residue is dried and weighed and the loss in weight is calculated to percentage of TNT. The dried residue is extracted with hot acetone, dried, and weighed. The loss in weight is calculated to percentage of RDX. The weight of the final residue is calculated to percentage of aluminum.

(g) The shaped charge efficiency of torpex relative to TNT as 100 is:

	Glass cones	Steel cones
Hole volume	150	145
Hole depth	127	131

c. Quaternary Mixtures.

(1) Depth bomb explosive (DBX) is the only explosive covered under quaternary mixtures. DBX consists of:

TNT	40 percent
RDX	21 percent
Ammonium nitrate	21 percent
Aluminum	18 percent

DBX was developed to replace the more sensitive torpex. As the name indicates, the primary use of DBX is in depth charges. The mixture is a gray solid that is slightly hygroscopic and, except for the aluminum, is soluble in acetone. The density of the cast material is from 1.61 grams per cubic centimeter to 1.76 grams per cubic centimeter. The method of manufacture is similar to that of torpex except that casting is done at 90°C to 95°C.

(2) The impact sensitivity of DBX is slightly less than that of TNT; 10 inches on the Picatinny Arsenal apparatus versus 14 inches for TNT. In the rifle bullet impact test about 49 percent of the samples exploded from the impact of a 30 caliber bullet at a distance of 2,743 meters (90 feet). The five second explosion test value is 200°C. The minimum detonating charge is 0.20 grams of lead azide and 0.10 grams of tetryl.

(3) The sand test results indicate a brisance of 112 percent of TNT. The detonation velocity is 6,630 meters per second for a density of 1.65 grams per cubic centimeter and 6,800 meters per second at a density of 1.76 grams per cubic centimeter. By the ballistic mortar test the power of PBX is 146 percent of TNT. For the 100°C vacuum stability test, 0.6 cubic centimeters of gas are evolved in 40 hours. The energy of the air blast is 138 percent of TNT and the energy of the water blast is 143 percent of TNT.

d. Plastic Bonded Explosives (PBX).

(1) PBX is a term applied to a variety of explosive mixtures which have high mechanical strength, good explosive properties, excellent chemical stability, relative insensitivity to handling and shock, and high thermal input sensitivity. The detonation velocity of PBX's is usually above 7,800 meters per second, the average autoignition temperature is above 250°C and the shock sensitivity is usually 10 to 40 percent above that required for detonating the basic explosive. PBX's contain a large percentage of basic explosives such as RDX, HMX, HNS, or PETN in intimate mixture with a polymeric binder such as polyester, polyurethane, nylon, polystyrene, various types of rubbers, nitrocellulose, or teflon. In some instances a plasticizer such as dioctylphthalate (DOP), DPA, or butyldinitrophenylamine (BDNPA) is included in the ingredients as well as a fuel such as powdered aluminum or iron.

(2) Much of the advantage stemming from the use of PBX lies in the simplicity of the technique of end item manufacture. About half of the developed PBX composites are used to directly cast end items. For this procedure no elaborate melting equipment or controlled cooling cycles are required. All operations may be conducted at ambient temperatures or, in some instances, can even be carried out in the field. However, where extraordinary mechanical strength is required or where complicated shapes are desired, a pressing or injection technique is applied using a molding powder or slurry of the PBX. The final PBX product not only exhibits excellent technical properties but also has the economical advantages of low processing costs and the ready availability of all constituents from commercial sources.

In currently evolved compositions, recycling and disposal present no special difficulties because thermally degradable binders are used. Ideally, the binders undergo controlled thermal degradation so that the material can be easily removed from explosive casings for the purpose of efficient recycling of the base explosive or low pollution disposal of the entire item.

(3) Several manufacturing procedures are currently used to produce PBX's. One of these techniques is that of casting. This procedure, at first glance, merely involves combining a dried explosive, such as HMX, with binder constituents and curing initiators in a mixing vessel, blending to desired homogeneity, then casting into a given warhead or other ordnance item. Unfortunately, there are hazards associated with the drying of large quantities of explosives such as HMX or RDX. Hence, a desensitizing procedure must be added for production-scale operations. This procedure involves coating the water wet HMX or RDX with the alkyd or polyester portion of the binder. The resulting lacquer is added slowly to an aqueous slurry of the HMX or RDX. Agitation at 250 revolutions per minute in the presence of water causes the resin to precipitate onto the surface of the HMX or RDX, producing an insensitive powder which may be safely dried, handled, shipped, and stored until ready for use in the final PBX composition. The precoated explosive is then combined in a mixing kettle with sufficient copolymer to constitute the final binder composition. At this point an accelerator such as cobalt naphthenate is added. The mixture is then stirred until homogeneous, at first under ambient pressure and finally in a partial vacuum to remove entrapped air. A

curing agent such as methyl ethyl ketone peroxide is then added. After another short mixing period, the explosive composition is poured into the desired mold. Vacuum casting has not been found necessary to obtain good density provided that the mold design is not too intricate or the height-to-diameters ratio not too great. Another method of casting is called injection molding. This method is used to produce intricate shaped or small diameter castings. The PBX usually employed with this technique has a high solid content of explosive such as PETN, which provides for steady state detonation in small cross-sectional channels or tubes. This method was developed by the Navy to provide explosive logic links of less than .25 centimeters in diameter. Figure 8-91 illustrates the injection molding process. The technique of injection molding involves movement of explosive material at room temperature into a cavity or tubing from a reservoir. This is accomplished by applying about 82,740 kilopascals (12,000 pounds per square inch) to the piston. This forces the explosive into the cavity or tube. When the accepting device is full, pressure on the piston is relaxed and flow stops. The device is then removed and set aside to allow the explosive to polymerize into an elastic, rubber-like solid. A second manufacturing technique produces a molding powder which is pressed into the desired end item shape under pressure in excess of 206,850 kilopascals (30,000 pounds per square inch). A slurry method can be used to prepare RDX type PBX's. In this method 42.5 grams of polystyrene and eight cubic centimeters of dioctylphthalate were dissolved in 200 cubic centimeters of toluene in a lacquer dissolver. Steam is introduced into the jacket until the temperature is 65°C. The lacquer is agitated constantly then added to a granulator. This lacquer contains a four to one ratio of plastic-plasticizer to toluene. The granulator which is agitated at 400 revolutions per minute, contains 450 grams of RDX and 4,500 grams of water which has been heated to 75°C. The lacquer solution is poured into the granulator followed by a solution of gelatin in water. Mixing is continued for five minutes to insure the RDX is well dispersed. Granulation takes place at this point. Steam is introduced into the jacket again to distill the solvent until the temperature reaches 98°C. Cooling water is then run into the jacket to cool the batch to 40°C. The coated material from the granulator is collected on a Buchner funnel and dried in a tray at 70°C for 24 hours.

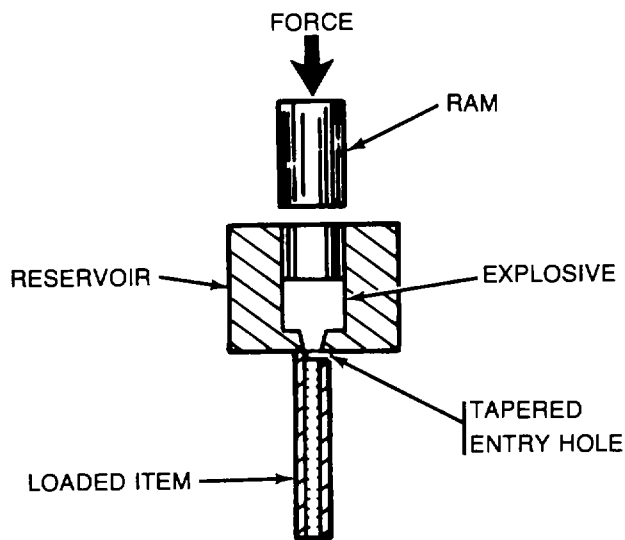

Figure 8-91. Injection loading operation.

(4) Table 8-76 lists the composition of the PBX's currently produced and used for military purposes.

Table 8-76. PBX Compositions

Designation	Composition
PBXN-4	94 percent DATB 6 percent nylon
PBXN-5	95 percent HMX 5 percent copolymer of vinylidene fluoride and hexafluoropropylene
PBXN-6	95 percent RDX 5 percent copolymer of vinylidene fluoride and hexafluoropropylene
PBXN-201	83 percent RDX 12 percent copolymer of vinylidene fluoride and hexafluoropropylene 5 percent polytetrafluoroethylene (teflon)
PBX-0280	95 percent RDX 5 polyethylene binder
PBX Type I	90 percent RDX 8.5 percent polystyrene 1.5 percent Dioctylphthalate (DOP)
PBXC-116	86 percent RDX 14 percent elastomeric binder
PBXAF-108	82 percent RDX 16 percent plasticizer 2 percent binder

PBXN-5 is also known as LX-10-0. This compound has blue-green spots on a white background. The theoretical maximum density is 1.896 grams per cubic centimeter with a nominal density of 1.86 to 1.87 grams per cubic centimeter. The melting point, with decomposition, is greater than 250°C, and the heat of formation is -31.4 calories per gram. The heat of detonation with liquid water is 1.55 kilocalories per gram and the heat of detonation with gaseous water is 1.42 kilocalories per gram. In the LANL small scale gap test a hot pressed charge of density 1.872 grams per cubic centimeter and a pressed charge of density 1.857 grams per cubic centimeter had 50 percent points of 2.25 .25 millimeters and 2.29 millimeters, respectively. Figure 8-92 shows the DTA curve for PBXN-5.

e. Industrial Explosives.

(1) Dynamites.

(a) Military operations frequently necessitate excavation, demolition, and cratering operations for which the standard high explosives are unsuited. Recourse is made to commercial and special compositions. Commercial blasting explosives, with the exception of black powder, are referred to as dynamites although in some cases they contain no nitroglycerin.

(b) Nobel gave the name dynamite to mixtures of nitroglycerin and kieselguhr, the strength of the dynamite being indicated by the percentage of nitroglycerin in the mixture. Kieselguhr is a chemically inert but porous material. Nitroglycerin absorbed by kieselguhr is much safer to handle than the unabsorbed material. Later, even stronger dynamites were made by substituting sodium nitrate and a combustible absorbent, such as wood pulp, for the kieselguhr. The resulting composition was called an active dope dynamite. Subsequently, the replacement of part of the nitroglycerin and sodium nitrate by ammonium nitrate brought into existence the less costly ammonia dynamites that are notable for their great heaving rather than shattering effects. The replacement of nitroglycerin in dynamite by nitrostarch resulted in the development of a class of dynamites free from some of the objectionable characteristics of nitroglycerin dynamites. While the active dope and ammonia dynamites are hygroscopic and desensitized by water, necessitating a moisture-proof wrapper, a waterproof composition termed blasting gelatin is obtained by colloiding nitrocellulose with nitroglycerin. When mixtures are made of 88 to 92 percent of nitroglycerin and 8 to 12 percent of nitrocellulose having a nitrogen content of about 12 percent, a relatively tough material is formed. Blasting gelatins are particularly adapted to deep-water blasting. By including some nitrocellulose in the compositions of active dope dynamites, the so-called gelatin dynamites were formulated.

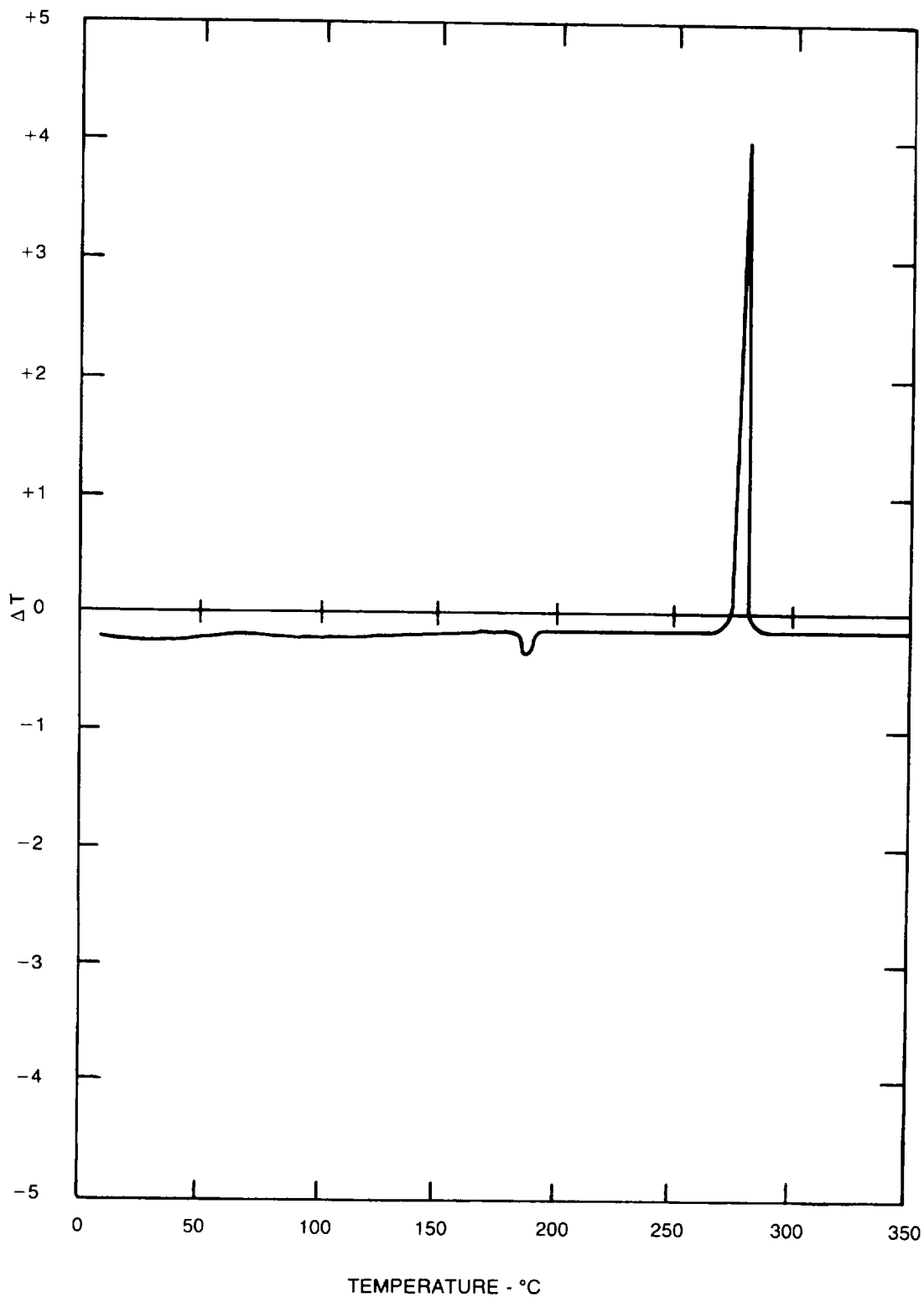

Figure 8-92. DTA curve for PBXN-5.

These possess greater density and water resistance than straight active dope dynamites and so are more suitable for use under wet conditions.

(c) The cost of glycerin and the tendency of nitroglycerin to freeze at some atmospheric temperatures prompted the partial replacement of nitroglycerin by antifreeze materials such as nitrated diglycerin, sugars, and glycols. Antacid materials such as calcium carbonate or zinc oxide have been added to most dynamite compositions to neutralize any acidity developed during storage. The inclusion of special purpose ingredients such as sulfur, ferrosilicon, alum, nitrotoluenes, sodium chloride, copper sulfate, etc and the substitution of starch, ground peanut hulls, vegetable ivory, etc, for wood pulp have further increased the complexity of dynamite compositions. Usually, they are formulated so as to have certain rate

of detonation and heaving force values that render them suitable for various types of blasting operations. At the same time care must be taken that the compositions are oxygen balanced when the paraffined paper wrapper is taken into consideration. Compositions overbalanced with respect to oxygen produce nitrogen oxides on detonation while underbalanced compositions produce some carbon monoxide instead of carbon dioxide. While many of the commercial dynamites are given strength designations on a percentage basis, this no longer means that they contain that percentage of nitroglycerin or have the same characteristics as a mixture of kieselguhr and nitroglycerin containing that percentage of nitroglycerin. Representative compositions and characteristics of the various types of dynamite are given in table 8-77.

Table 8-77. Compositions¹ and Characteristics of Dynamites

Strength of dynamite, percent	20	30	40	50	60	100
Straight dynamites:						
Nitroglycerin	20.2	29.0	39.0	49.0	56.8	-
Sodium nitrate	59.3	53.3	45.5	34.4	22.6	-
Carbonaceous fuel	15.4	13.7	13.8	14.6	18.2	-
Sulfur	2.9	2.0	-	-	-	-
Antacid	1.3	1.0	0.8	1.1	1.2	-
Moisture	0.9	1.0	0.9	1.2		
Rate of detonation, m/sec	3,600	4,300	4,800	5,150	5,900	-
Ballistic pendulum, percent TNT	83	90	94.5	102.5	114	-
Ammonia dynamites:						
Nitroglycerin	12.0	12.6	16.5	16.7	22.5	-
Sodium nitrate	57.3	46.2	37.5	25.1	15.2	-
Ammonium nitrate	11.8	25.1	31.4	43.1	50.3	-
Carbonaceous fuel	10.2	8.8	9.2	10.0	8.6	-
Sulfur	6.7	5.4	3.6	3.4	1.6	-
Antacid	1.2	1.1	1.1	0.8	1.1	-
Moisture	0.8	0.8	0.7	0.9	0.7	-
Rate of detonation, m/sec	2,700	-	3,300	3,900	4,600	-
Ballistic pendulum, percent TNT	81	-	91	99	109	-
Gelatin dynamites:						
Nitroglycerin	20.2	25.4	32.0	40.1	49.6	91.0 ²
Sodium nitrate	60.3	56.4	51.8	45.6	38.9	-
Nitrocellulose	0.4	0.5	0.7	0.8	1.2	7.9
Carbonaceous fuel	8.5	9.4	11.2	10.0	8.3	-
Sulfur	8.2	6.1	2.2	1.3	-	-
Antacid	1.5	1.2	1.2	1.2	1.1	0.9
Moisture	0.9	1.0	0.9	1.0	0.9	0.2
Rate of detonation, m/sec	4,000	4,600	5,150	5,600	6,200	7,400
Ballistic pendulum, percent TNT	70 - 74	79	84.5 - 86	90.5 - 93	99 - 101	143

Table 8-76. Compositions' and Characteristics of Dynamites (Cont)

Strength of dynamite, percent	20	30	40	50	60	100
Ammonia gelatin dynamites:						
Nitroglycerin	-	22.9	26.2	29.9	35.3	-
Sodium nitrate	-	54.9	49.6	32.0	33.5	-
Ammonium nitrate	-	4.2	8.0	13.0	20.1	-
Nitrocellulose	-	0.3	0.4	0.4	0.7	-
Carbonaceous fuel	-	8.3	8.0	8.0	7.9	-
Sulfur	-	7.2	5.6	3.4	-	-
Antacid	-	0.7	0.8	0.7	0.8	-
Moisture-	-	1.5	1.4	1.6	1.7	-
Rate of detonation, m/sec	-	4,400	4,900	5,300	5,700	-
Ballistic pendulum, percent of TNT	-	83	88	92	97.5	-

¹Percent by weight

²Blasting gelatin

(d) In addition to military dynamite (h below), dynamites of the types described may be used for military operations and are procured as commercial items. A composition having great heaving force and relatively low rate of detonation is preferable for blasting soft rock or earth, while a gelatin dynamite of low heaving force and high rate of detonation is used for hard tough rock.

(e) A special demolition explosive standardized shortly before World War II is based on nitrostarch instead of nitroglycerin. The explosive is pressed into 1/4-pound pellets which are covered with paper and one pound packages of the pellets are wrapped in paper with markings indicating the location of holes for blasting caps in the pellets. The composition used is as follows:

	Percent
Nitrostarch	34.5 ±2.5
Barium nitrate	43.5 ±1.5
TNT	15.0 ±2.0
Aluminum	3.0 ± 1.0
Graphite	2.0 ± 1.0
Coal dust	1.5 ±0.5
Paraffin	0.6 ±0.6
Dicyandiamide	1.0 ±0.5
Moisture	0.75 ±0.75

The barium nitrate is coated with the paraffin before the ingredients are mixed together and pressed into pellets. The composition must not undergo ignition or explosion

when heated at 100°C for 48 hours and must have a density of 1.75+0.10 when pressed.

(f) Nitrostarch demolition explosive is sensitive with respect to crumbling or breaking action. No explosions occur in the pendulum friction test but explosions do occur in the rifle bullet impact test. The initiation sensitivity is slightly greater than that of TNT. The sand test indicates a brisance of 90 percent of TNT and the ballistic pendulum test indicates a power of 96 percent of TNT. The explosive is hygroscopic to the extent of 2.1 percent when exposed to air of 90 percent relative humidity at 30°C. Long term storage tests indicate a satisfactory stability. Some volatilization, rather than decomposition, occurs in the 100°C heat test in 96 hours. A weight loss of one percent with no signs of deterioration is reported in the 75°C international test.

(g) During World War II, a cratering explosive with the following composition was used.

	Percent
Ammonium nitrate	86.6
Dinitrotoluene	7.6
Ferrosilicon	5.7
Red dye	0.1

This inexpensive and easily manufactured explosive is very insensitive to shock and initiation, has a low rate of detonation but high heaving force value, and is very stable. As it is somewhat hygroscopic in spite of the moistureproofing action of the dinitrotoluene, the explosive is packed in hermetically sealed containers.

(h) Military dynamite M1, M2, and M3 is a medium velocity (6,096 meters per second) blasting explosive in three cartridge sizes. Military dynamite M1, M2, and M3 has been standardized for use in military construction, quarrying, and service demolition work. The explosive composition is packaged in standard dynamite cartridge waxed-paper wrappers. The models differ only in the cartridge size. Cartridges are 1 1/4 inches in diameter by 8 inches long for the M1, 1 1/2 inches in diameter by 8 inches long for the M2, and 1 1/2 inches in diameter by 12 inches long for the M3. The composition used is: Percent

RDX	75 ±1.0
TNT	15±0.5
Grade SAE No. 10 engine oil plus polyisobutylene	5 ±0.5
Cornstarch	5 ±0.5

Desensitized RDX, which is coated with engine oil before mixing with the other ingredients, and grained TNT are used in the manufacture of the dynamite. Military dynamite M1, M2, and M3 is equivalent in strength to 60 percent commercial dynamite. The military dynamite is safer to transport, store, and handle than 60 percent straight nitroglycerine commercial dynamite and is relatively insensitive to friction, drop impact, and rifle bullet impact. The composition remains plastic at 57°C after 24 hours. Military dynamites are odorless, free from nitroglycerin toxicity, nonhygroscopic, and chemically stable when exposed to 80 percent relative humidity at 71°C for one month. No freezing occurs in cold storage or exudation in hot storage. Turning of shipping containers during storage is not necessary.

(2) Ammonium nitrate fuel oil explosives (ANFO).

(a) When ammonium nitrate is mixed with approximately 5.6 percent of a combustible material such as fuel oil, the heat liberated on detonation is increased by almost three-fold. The reaction proceeds according to the equation:

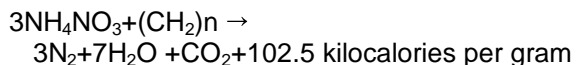

(b) Extremely insensitive to initiation, ANFO requires a high explosive booster containing 50/50 pentolite, composition B, or other similar high explosive. Sensitivity does vary somewhat with oil content. The maximum sensitivity is at about two to four percent, with a substantial reduction for greater concentrations of oil. Sensitivity is decreased by the presence of water, but decreasing the particle size or density of the ammonium nitrate prills increases sensitivity.

(c) The energy produced upon detonation is comparable to the energy produced by some of the less powerful military explosives, however, the detonation velocity is only about 4,300 meters per second in large diameter charges. With six percent oil, the detonation velocity is at maximum, but maximum energy is obtained with 5.5 percent oil. Increased charge diameter, up to about 13 centimeters, and confinement causes an increase in the velocity of detonation.

(3) Water gel and slurry explosives.

(a) Along with ANFO explosives, the water gel and slurry explosives have virtually replaced dynamite in mining operations. Water gel and slurry explosives have a higher energy content than ANFO, smaller critical diameter, and can be used in wet conditions. The gel explosives consist of ammonium nitrate with or without other oxidizing agents, explosive or nonexplosive sensitizers, fuels, and gelatin forming compounds in an aqueous medium. Slurry explosives contain the same ingredients with additional compounds that bond the solid particles and prevent water from defusing in and out of the slurry. The explosive sensitizers are such compounds as pentolite, TNT, methylamine nitrate, smokeless powder, and nitrostarch. Nonexplosive sensitizers can be finely granulated aluminum, gas bubbles in suspension, gas contained in small glass spheres, and porous solids. The fuels include coal dust, urea, sulfur, and various types of hydrocarbons. The gelatin forming compounds include guar gums, carboxymethyl cellulose, resins, and synthetic thickeners. The viscosity of the mix can be altered by the addition of cross linking agents like sodium tetraborate and potassium dichromate. Glycerol, methanol, and diethylene glycol may be added as antifreezes.

(b) The detonation characteristics of the water and slurry explosives vary considerably with the composition of the slurry. Detonation velocities vary from 4,300 to 6,050 meters per second and detonation pressures vary from 60 to 104 kilobar.

CHAPTER 9 UNITED STATES PROPELLANTS

9-1. Introduction. Selection of a propellant for an application is made on the basis of the requirements of that specific application. In general, guns are designed to meet specified performance standards and withstand a specific pressure in the barrel. With a knowledge of the properties of the constituents normally used for propellants, the propellant designer creates a formulation to satisfy the performance standards and limitations of the gun. When ignited, the propellant produces large quantities of hot, gaseous products. Complete combustion or deflagration of the propellant occurs in milliseconds in guns and the pressure produced accelerates the projectile down the barrel. Table 9-1 shows the approximate distribution of the energy content of the propellant.

Table 9-1. Distribution of Propellant Energy

Energy absorbed	Percent of total
Motion of projectile	32.0
Frictional work	2.0
Translation of gases	3.0
Heat loss to gun and projectile	20.0
Sensible and latent heat loss in gases	42.0
Rotation of projectile and recoiling parts	1.0

9-2. Chemical Composition of Propellants.

Properties of the principal energetic ingredients of common gun propellants (nitrocellulose, nitroglycerin, and nitroguanidine) are discussed in Chapter 8. The composition and selected properties of various gun propellants are shown in table 9-2. The formulations arise from needs to maintain the flame temperature at certain levels, and from a desire to achieve the maximum energy content within that flame temperature limitation. Low flame temperatures, low levels of carbon monoxide, and hydrogen in the muzzle reduce the tendency of a gun to exhibit secondary flash. The main reason for seeking low flame temperatures is to reduce barrel erosion. In certain propellant systems, the need for flash reduction impacts on the flame temperature limit permitted. Usually, potassium salts are sufficiently effective in eliminating secondary flash. Also to be considered are the cost of ingredients and the physical properties of the final propellant.

Table 9-2. Composition and Properties of Propellants

	M1	M2	M5	M6	M8	M10	M31	M30	IMR	M18
Nitrocellulose (NC), %	85.00	77.45	81.95	87.00	52.15	98.00	20.00	28.00	100.00	80.00
%o Nitrogen in NC %	13.15	13.25	13.25	13.15	13.25	13.15	12.60	12.60	13.15	13.15
Nitroglycerin, %	-	19.50	15.00	-	43.00	-	19.00	22.50	-	10.00
Barium nitrate, %	-	1.40	1.40	-	-	-	-	-	-	-
Potassium nitrate, %	-	0.75	0.75	-	1.25	-	-	-	-	-
Potassium sulfate, %	-	-	-	-	-	1.00 ^a	-	-	1.00 ^a	-
Lead carbonate, %	-	-	-	-	-	-	-	-	-	-
Nitroguanidine, %	-	-	-	-	-	-	54.70	47.70	-	-
Dinitrotoluene, %	10.00	-	-	10.00	-	-	-	-	8.00 ^b	-
Dibutylphthalate, %	5.00	-	-	3.00	-	-	4.50	-	-	9.00
Diethylphthalate, %	-	-	-	-	3.00	-	-	-	-	-
Diphenylamine, %	1.00 ^a	-	-	1.00 ^a	-	1.00	-	-	0.70	1.00
Ethyl centralite, %	-	0.60	0.60	-	0.60	-	1.50	1.50	-	-
Graphite, %	-	0.30	0.30	-	-	0.10 ^b	-	0.10 ^b	-	-
Cryolite, %	-	-	-	-	-	-	0.30	0.30	-	-

Table 9-2. Composition and Properties of Propellants (Cont)

	M1	M2	M5	M6	M8	M10	M31	M30	IMR	M18
Ethyl alcohol (residual), %	0.75	2.30	2.30	0.90	0.40	1.50	0.30	0.30	1.50	0.50
Water (residual), %	0.50	0.70	0.70	0.50	0	0.50	0	0	1.00	0
Isochoric flame temp T_v , K	2,417	3,319	3,245	2,570	3,695	3,000	2,599	3,040	2,835	2,577
Force, 1-lb/lbxl 0-3, F	305	360	355	317	382	339	334	364	331	319
Unoxidized carbon, %	8.6	0	0	6.8	0	4	8.7	3.2	2.7	6.8
Combustibles, %	65.3	47.2	47.4	62.4	37.2	54.5	49.8	41.0	59.2	66.6
Heat of explosion, cal/g	700	1,080	1,047	758	1,244	936	807	974	868	772
Gas volume, moles/g	0.04533	0.03900	0.03935	0.04432	0.03711	0.04068	0.04620	0.04308	0.04191	0.04457
Ratio of specific heat	1.2593	1.2238	1.2238	1.2543	1.2148	1.2342	1.2527	1.2385	1.2413	1.2523
Covolume, in. 3/lb	30.57	27.91	27.52	29.92	26.63	27.76	30.87	29.26	28.91	30.24
Density, g/cm ³	1.57	1.65	1.65	1.58	1.62	1.67	1.64	1.66	1.62	1.62

^aAdded.^bGlaze added.^cBall propellant.

a. The single-base propellants shown in table 9-2 are M1, M6, M10, and IMR. Nitrocellulose is the principal energetic material. These are low cost propellants that have a low flame temperature and low energy content. To reduce the flame temperature and barrel erosion, recent formulations of the IMR propellants do not use dinitrotoluene. Ethylene dimethacrylate and methyl centralite are among the replacement materials which produce much lower flame temperatures. IMR is considered a single-base propellant even though the formulation contains a small amount of nitroglycerin.

b. The double-base gun propellants shown in table 9-2 are M2, M5, M8 and M18. In these formulations the nitrocellulose is gelatinized by nitroglycerin. The presence of an active gelatinizer makes double-base propellants more energetic than single-base propellants. The ballistic potential is increased correspondingly. The flame temperature and resulting barrel erosion is also increased. Other aliphatic nitrate esters are also used to gelatinize the nitrocellulose. DEGN is the most widely used gelatinizer but DEGN has the undesirable property of being more volatile than nitroglycerin and so, makes the propellants less stable.

c. The triple-base gun propellants contain nitroguanidine as additional energizer which increases the energy content of the formulation without raising the flame temperature. This reduces gun barrel erosion with no sacrifice in performance. In addition, the triple-base propellants have a substantially reduced concentration of combustibles such as hydrogen and carbon monoxide in the product gas. This reduces the flash from the gun barrel.

d. Composite propellants, used in solid fuel rockets, contain a polymer binder, a fuel, and an oxidizer.

9-3. Thermochemistry. Thermochemical properties are prime considerations in formulating a propellant for a specific application. The thermochemical properties include the flame temperature of the gases produced by the propellant under certain standard conditions, their average molecular weight, and covolume. The commonly used equation of state used with the combustion products of gun propellants (for gun applications) is:

$$P(V - b) = nRT$$

where P is the pressure, V is the volume, b is the covolume, n is the number of moles of the gas per unit mass, R is the universal gas constant, and T is the temperature. The ideal gas equation of state is obtained in the case where b equals zero. The covolume is a correction factor to take into account the extremely high pressures, 137,900 to 482,650 kilopascals (20,000 to 70,000 pounds per square inch), that exist in a gun barrel. Physically, the covolume is defined as the volume actually occupied by the gas molecules. Laboratories dealing with propellants have a variety of methods available, including computer programs, that are used routinely to estimate the thermochemical properties of propellants from basic chemical data. The simplest of these is the Hirschfelder-Sherman calculation in which the adiabatic, isochoric flame temperature T_v , heat of explosion Q, moles of gas per gram n, impetus (force)

$F = nRT/v$, ratio of specific heats, and covolume are calculated. An equilibrium computer program called the BLAKE code, formulated on the basis of a virial coefficient equation of state, has been devised for gun use. The usual input required for equilibrium propellant performance calculations consists of the chemical composition, the heat of formation (H_f at 2980K), and the elemental formula of each ingredient. Several extensive compilations of heat of formation data are available. Several techniques are available for estimating the heat of formation of compounds by addition of bond energies and/or group contribution where experimental data are lacking. A computer program has been developed for estimation of chemical thermodynamic data called "Chetah" (chemical, thermodynamic, and hazard appraisal). The estimated values obtained by these methods are usually for compounds in the ideal gaseous state. Therefore, the heat of vaporization and, sometimes, the heat of fusion must be taken into account to obtain the heat of formation of the compound in its normal state at 2980K. Experience indicates that the results of propellant performance calculations are not extremely sensitive to errors in the heat of formation of the ingredients. Recently, methods have been developed for calculating certain transport properties (for example, the thermal conductivity and viscosity) of the combustion product gases under specific conditions of temperature and pressure.

9-4. Physical Properties. Gun propellants must function reliably over a large ambient temperature range (for example, 54° to +74°C) and they must retain their performance characteristics during many years of storage. The propellant grains must retain their integrity in the face of a severe blast from the ignition system. This quality must be demonstrated particularly at low temperatures where the propellants tend to be brittle. The propellant grains must not soften excessively at high temperature because then they can be deformed by the ignition pulse. If this occurs, the propellant bed might be compressed so tightly that the ignition gases might not percolate satisfactorily through the bed. A number of physical properties of propellants are occasionally of interest to the ammunition designer. Among these properties are thermal expansion, thermal conductivity, specific heat, and thermal diffusivity. The following properties are of direct interest to the charge designer:

a. *Density.* Conventional single and double-base propellants have values of approximately 1.60 grams per cubic centimeter, while triple-base (nitroguanidine) propellants are slightly higher. This is advantageous for tank ammunition where the maximum amount of propellant charge is required to meet the desired ballistic levels.

b. *Bulk Density.* This often is referred to by such terms as "gravimetric density" and "screen loading density" depending on the test utilized. The values reported are empirical and are greatly dependent on the specific gravity of the propellant, the grain geometry, surface characteristics, and the measuring technique.

The term "bulk density" often is confused with loading density, a term that the ballisticians use for the ratio of the charge weight in a system to the chamber volume.

c. *Compressibility of Grains.* This is a measure of how much a propellant grain can be compressed before cracks appear. The usual required minimum value for gun propellants at 25°C is 30 percent. That value is based on historical experience.

9-5. Manufacture. The manufacturing methods for various types of propellants are given below.

a. *Single-Base Propellants.* The manufacture of nitrocellulose is discussed in chapter 8. Wet nitrocellulose from the manufacturing process is dehydrated after the moisture content has been reduced to approximately 28 percent by wringing. Dehydration is accomplished by pressing the nitrocellulose at low pressure so as to squeeze out some water, adding 95 percent ethanol, and pressing at about 24,133 kilopascals (3,500 pounds per square inch). A block containing 11.4 kilograms (25 pounds) of dry nitrocellulose and about one-third that much of 90 percent ethanol is obtained. The wet block is broken up into small lumps by means of a rotating drum containing iron prongs and a screen. The nitrocellulose is transferred to a watercooled mixing machine of the dough-mixer type and, while this is in operation, ether equal to approximately two-thirds of the weight of dry nitrocellulose is added.

Any plasticizing agents and stabilizers to be included in the composition are dissolved in or mixed with the ether prior to addition to the nitrocellulose. After addition of the ether is complete, materials such as potassium nitrate are added. Mixing of the ingredients is continued for about one hour. A partially colloid mixture which resembles dry oatmeal is produced. By pressing this at approximately 20,685 kilopascals (3,000 pounds per square inch) so as to form a block, the degree of colloid is increased rapidly. This effect is further increased and uniformity of the mixture is improved by subjecting it to a pressure of about 24,133 kilopascals (3,500 pounds per square inch) in a macaroni press.

Here the material is squeezed through a series of screens and perforated plates and emerges in a form resembling that of macaroni. This is pressed again to form a block of well colloid material. This is placed in a graining press and extruded through a carefully designed die by the application of pressure. The material emerges as a cord with one or more cylindrical perforations.

The cord is cut into pieces of predetermined length. Removal of the volatile solvent, with shrinkage of the grains to their final dimensions, is accomplished by three operations. In the solvent recovery operation, the powder is placed in a large tank and warm air or other gas is passed through the mass. With careful control, so as to prevent surface hardening, the temperature of the air is gradually increased to not more than 65°C. The solvent recovery operation requires from 2 to 14 days, depending upon the size of the grain, and reduces the solvent content to approximately six percent. The water dry operation consists of placing the partially dried powder in water at about 25°C and gradually increasing the temperature to a maximum of 55°C. After a number of days, the residual solvent is reduced to 0.3 to 5 percent, depending upon the grain size. The powder now is air dried to remove surface moisture and screened to remove dust and grain clusters. The final operation before packing is to blend all the powder in a lot, which may vary from 22,700 to 227,000 kilograms depending on the type of powder. This is accomplished by transferring the powder from one conical bin to another by gravity flow. This blending improves uniformity of the lot with respect to composition and external moisture content.

b. *Double-Base Propellants.* Double-base propellants are manufactured by two methods. The solvent process is similar to that used for single-base powders except that a mixture of ethanol and acetone is used as the solvent and the solvent recovery procedure is omitted because of the hazard involved in recovering solvents containing nitroglycerin. The solventless process is used when the nitroglycerin and any other colloid agents constitute approximately 40 percent of the composition. In this process the wet nitrocellulose is blended with the nitroglycerin in a tank filled with water. Ethyl centralite is mixed in and the bulk of the excess water is removed by centrifuging. The resulting paste is put in cotton bags and subjected to heated air currents to reduce the moisture content. The remaining constituents are then blended with the partly dried paste. Repeated rolling between heated steel rollers removes the rest of the water and completes colloid of the nitrocellulose. The thickness of the sheet formed is controlled carefully and varies with use. If the sheet is to be cut into flakes for use in small arms or mortars, the thickness is between 0.08 and 0.32 millimeter (0.003 and 0.0125 inch). Sheets to be extruded in the form of

large grains for use in rockets may be as thick as 3.18 millimeters (0.125 inch).

c. *Triple-Base Propellants.* The manufacturing process used for the nitroguanidine triple-base propellants in the United States has been uniformly solvent extrusion. The amount of solvent used is quite low so the propellant is very soft during extrusion. The soft strands may require partial drying before cutting in order not to deform the cross section at the cut. Removal of solvent from the triple-base propellant is rapid, possibly due to diffusion of solvent within the grain along the crystal-plastic interfaces. In order to make a good quality grain, lower drying temperature gradients are used in order to avoid steep solvent gradients resulting in distortion and cracking.

d. *Composite Propellants.* A composite propellant is manufactured by a simple mixing operation, cured, and molded into grains or poured directly into the rocket case and cured by heating in controlled ovens.

Operational temperatures extend from -40° to +60°C.

The high solid content requires great resin strength and good elastic properties to withstand low temperatures.

Precise control of the oxidizer particle size is needed to control ballistic properties. Rockets up to 6.6 meters in diameter and weighing up to 45,400 kilograms have been fired successfully. The dense smoke produced by these propellants limits their use to long range systems where the signature of the rocket does not easily reveal the firing point.

e. *Ball Propellants.* Ball propellants are used for small arms. The nitrocellulose used to make the propellant is extracted from waste single-base propellant. To produce the propellant in ball form, water-wet nitrocellulose is mixed with ethyl acetate, colloid with animal glue, and agitated; excess water causes the propellant to precipitate in a ball. The animal glue is washed away using hot water. The propellant is screened to size and nitroglycerin is added in the presence of ethyl acetate. The nitroglycerin is absorbed by the ball propellant, the ethyl acetate is driven off, and the ball is carried to a roll mill to cause cracks, that serve as combustion sites, to form in the ball. The propellant is then dried and a deterrent coating such as Dibutylphthalate is added. The deterrent reduces the burn rate of the propellant to an acceptable level.

9-6. Propellant Grain Geometry. The burning time of a propellant charge depends on two factors. One factor is the velocity at which the exothermic decomposition reaction occurs. This is called burning rate. The other factor is the total surface area of propellant exposed. In order to control the surface area available for reaction, propelling charges consist of numerous propellant grains. Propellant grains can have a variety of shapes as shown in figure 9-1. An additional grain geometry, the flake, is also used in mortars. The shape of the grain determines how much surface area is exposed as burning proceeds. For example, as a cord burns, the surface area of exposed propellant decreases. This is called a degressive grain. As a single perforated grain burns, the exposed surface area remains nearly constant because the outer surface area decreases as the inner surface area increases. This is called a neutral grain. In a progressive grain, for example the multi-perforated and rosette, the surface area increases during burning. The grain geometry and burning rate are interrelated. The burning time of a propelling charge that contains a propellant with a high burning rate and strongly digressive grain geometry could be equal to the burning time of a charge that contains a propellant with a low burning rate and strongly progressive grain geometry. European nations have favored the use of single perforation, strip, and cord propellants. The United States uses single perforation and multi-perforation propellants. The single perforation grains may be slotted or unslotted. The slotted grain has the desirable characteristic of venting gas during combustion. All countries use ball propellants for small arms. In a multi-perforation or rosette grain that consists of a propelling compound with a specific linear

burning rate, the burn time can be varied by varying the web thickness. The web thickness, shown in figure 9-2, is the average dimension of the outer web and inner web. In general, the finer the web the shorter is the burning time of the propellant charge. The grain dimensions also influence the burning time. The finer the web the higher the pressure produced. A cannon is designed to operate with a maximum pressure. This pressure must be taken into account when designing the grain web. The same projectile velocity can be attained with a smaller amount of propellant with fine web and with a larger amount of propellant with a coarse web. However, the pressure with the former is considerably greater than the latter. In general, the heavier the projectile or the greater the prescribed velocity, the larger the powder grain and web used. As shown in figure 9-2, the burning of a seven perforation grain produces 12 unburned slivers or pieces of triangular cross section that represent approximately 15 percent of the total weight of the grain. These slivers burn digressively and usually are burned in the bore of the weapon; but if the tube is relatively short or a reduced charge of propellant is fired, incompletely burned slivers may be expelled from the muzzle. The rosette or Walsh grain (figure 9-1) with a scalloped outer periphery, reduces the number of slivers produced by a multi-perforation grain and therefore reduces or eliminates the amount of unburned powder ejected. In practice, there are certain general relationships between the dimensions of powder grains. These dimensions must remain within fairly narrow limits. Specification requirements for cannon powders include the relative dimensions which follow.

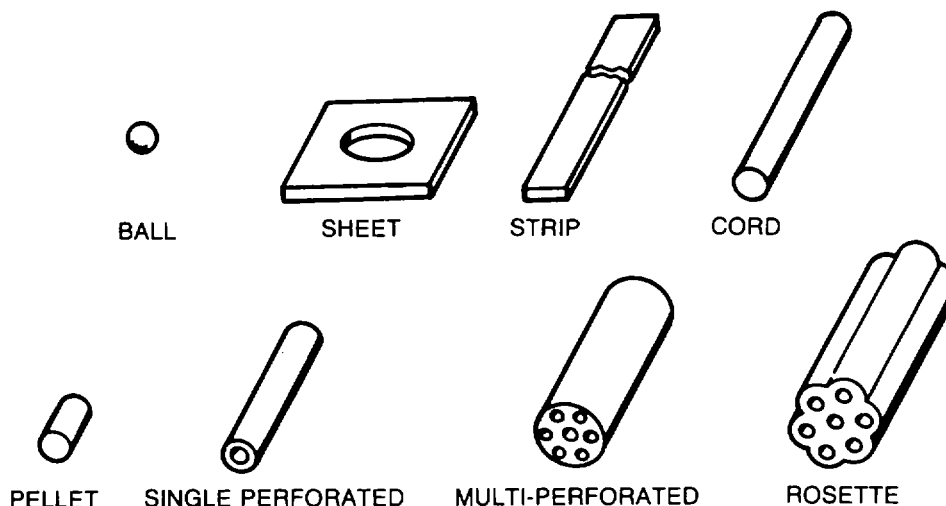

Figure 9-1. Typical shapes of propellant grains.

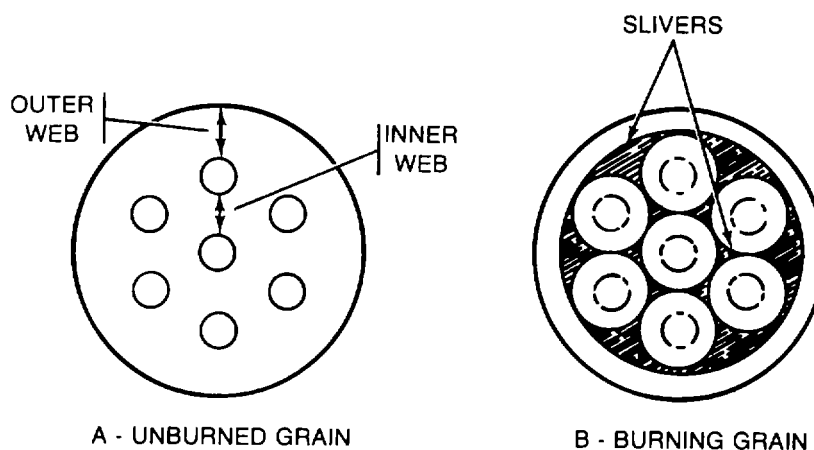

Figure 9-2. Web thickness and direction of burning through a progressively burning grain.

a. The ratio of average grain length (L) to average grain diameter (D) is 2.10 to 2.50 for multi-perforation grains and 3 to 6 for single perforation grains.

b. The ratio of average grain diameter (D) to the average diameter of perforations (d) is 5 to 15 for multi-perforation grains and approximately three for single perforation grains.

c. The difference between the average outer web thickness (Wo) and the average inner web thickness (Wi) of multi-perforation powder is not more than 15 percent of the average web thickness (Wa).

9-7. Burning Rates. Ballisticians view the propellant grains as burning in parallel layers, where the burning proceeds in a direction perpendicular to the surface. This universally accepted concept is known as Piobert's law and is supported by the experience of many investigators drawing their conclusions from many different approaches. The linear burning rate vs pressure behavior of a gun propellant (the rate at which burning proceeds normal to the surface) is a characteristic of the composition and is a required input for most interior ballistics calculations.

a. The burning rate is independent of grain geometry. Results of the two tests usually used to determine burning rates (the strand burner and closed bomb) are the same for cord, single perforation, and seven perforation grains. The closed bomb is used most commonly to determine relative force (RF) and

relative quickness (RQ) of gun propellants. In this determination, a test propellant is fired in a closed bomb and the results are compared with those obtained with a reference propellant fired under identical conditions. RF is defined as

$$RF = \frac{P_{max} \text{ test propellant}}{P_{max} \text{ reference propellant}}$$

RQ is defined as

$$RQ = \frac{dP/dt \text{ test propellant}}{dP/dt \text{ reference propellant}}$$

where dP/dt is the rate of change of pressure with time.

b. Burning rate vs pressure data commonly are fitted to an equation of the form

$$r = bP^n$$

known as de Saint Robert's equation. Plots of the log of the burning rate vs the log of the pressure of many propellants yield straight lines. Under that condition, b and n are constants. Table 9-3 gives values of b and n for several of the standard propellants. Using the values specified, the burning rate equation yields r in inches per second when P is in pounds per square inch.

Table 9-3. Burning Rate Parameters for Several Standard Gun Propellants

Propellant	M1	M2	M6	M10	M30
<i>b</i>	0.002143	0.002432	0.002989	0.004004	0.00576
<i>n</i>	0.710	0.755	0.702	0.695	0.652

c. The burning rate of gun propellants generally increases with initial propellant temperature. The temperature coefficient of the burning rate is defined as the ratio of the change in burning rate and the change in temperature at constant pressure. Typical values for the temperature coefficient are 0.077 percent per degree centigrade at 206,850 kilopascals (30,000 pounds per square inch) for M 10 and 0.05 percent for M30 under the same conditions.

d. The burning rate of conventional propellants increases with increasing flame temperature. Several empirical correlations have been developed which provide a means for estimating burning rates of different propellant formulations from the adiabatic flame temperature.

e. Propellants used in small arms usually have a deterrent impregnated into their surface which alters the chemical composition of the outer portion of the grains to slow the initial burning rate. Commonly used deterrents include dinitrotoluene and ethyl centralite. The deterrent has a moistureproofing effect and usually a melting point of less than 1 00°C. A coating of deterrent is applied by tumbling the propellant powder in a "sweetie" barrel in a water slurry with the deterrent at a temperature above the melting point of the deterrent.

f. The burning rate of solid propellants increases with increasing product gas velocity near the surface. This phenomenon is referred to as erosive burning. The extent of erosive burning depends on grain geometry and composition. Relatively "hot" propellants are apparently less subject to erosive burning than are "cool" ones. The inner surface of long tubes does not, apparently, burn in an even, uniform manner. The holes increase in size faster at the ends. Slotted tubes burn closely in conformance to Piobert's law.

g. The actual burning rate of solid propellants also deviates from the steady-state or expected value under rapid pressure excursions. That is, the instantaneous burning rate then will differ significantly from that expected for the corresponding instantaneous pressure. This phenomenon, called dynamic burning, has not been studied enough to present corrections to the burning rate equation.

9-8. Ignitability. Ignition of a propellant charge is accomplished by raising the temperature of the propellant surface to the ignition temperature. The simultaneous ignition of all the exposed surfaces is desirable for many gun applications. Black powder is used extensively for artillery and rocket propelling charge ignition.

Black powder is a more efficient igniter than finely divided propellant, which is used in mortars, because it does not produce as much gas per unit weight as propellant, its use reduces ignition shock, it yields high initial pressures, and the hot particles in its combustion products assist in transferring heat to the propellant surface.

a. An increase in the nitrogen content of the nitrocellulose causes slight increase in ignitability.

b. The substitution of nitroglycerin for part of the nitrocellulose in a composition increases ignitability to a marked extent.

c. The inclusion of an inert, gelatinizing agent, such as Dibutylphthalate or triacetin, in a propellant composition results in a decrease in ignitability.

d. The inclusion of TNT or dinitrotoluene in a composition causes measureable decrease in ignitability.

e. The inclusion of five percent or less of potassium nitrate in a composition causes a significant increase in ignitability.

f. The presence of a deterrent on a propellant causes retardation of ignition.

g. As the initial temperature of the propellant decreases, the ignitability decreases.

9-9. Charge Design Considerations. The selection of a propellant for a particular application is determined by cost, by the interior ballistics requirements, by propellant/weapon interface considerations, and by limitations with respect to muzzle effects. The propellant with the lowest cost formulation and the lowest flame temperature that still will meet the velocity and pressure requirements is generally used. Other important considerations are the effects on ballistic performance of various propellant grain shapes and the problem of matching the gas production rate

from propellant burning to the rate of increase of volume in the gun behind the accelerating projectile. The shape of the grain also affects the amount that can be loaded in a given space and can control the generation of pressure waves in large caliber guns. The charge weight sometimes is restricted in large caliber guns by the momentum limit. The gas expelled from the muzzle adds to the total forward momentum. The propellant charge plays a major role in gun fouling and erosion. This field is receiving considerable attention at this time and in recent years, erosion often has been reduced dramatically by means of wear-reducing materials that are added to the propellant composition or to the charge as cartridge case liners. Efforts usually are made to minimize muzzle flash and smoke. Muzzle flash and smoke are related in a sense and have been investigated extensively. Two components contribute to muzzle flash: the primary flash and the secondary flash. The primary flash is caused by incandescent hot gases emerging from the muzzle or heated to incandescence by the shock following the projectile out of the gun. The secondary flash is caused by the burning of combustible muzzle gas when mixed with air and heated to ignition by the shock wave. Ignition of the gas cloud is also caused by the early, bright burning of tracers. This is a voluminous, relatively long lived event and is far more objectionable than the primary flash. In small caliber weapons, secondary muzzle flash is suppressed effectively in many weapons by means of mechanical devices attached to the muzzle. Various chemical additives, especially alkali metal salts, are very effective and widely used to suppress secondary flash. The salts may be incorporated into the compositions, or they may be loaded as separate components in the charge. Secondary flash is also reduced by reduction of the propellant composition flame temperature and by reduction of the proportion of combustible gases produced by the propellant. Gun smoke is due to particulate, usually inorganic, material emerging from the gun behind the projectile. Primer and igniter combustion products, barrel scrapings, and solid combustion products from the propellants are the major constituents of gun smoke. The visibility of the smoke or smoke density is due largely to the products from the alkali metal salt flash suppressant. These constituents also are responsible for the substantial increase of smoke density under humid conditions.

9-10. Ballistic Effects. The study of the combustion of a propellant in a confined volume, and the resultant rate of gas generation combined with its

effect on the acceleration of a projectile, is called interior ballistics. Figure 9-3 shows a representative pressure travel curve for a projectile in a gun. The further the point of maximum pressure (points A, B, and C) is from the powder chamber, the greater the velocity acquired by the projectile. This is the reason the United States favors the use of multiperforated grains.

a. There are four general equations which form the basis of interior ballistics.

(1) The burning rate equation is the first of the four. This equation has already been discussed.

(2) The equation of the form takes into account the propellant grain geometry. The web fraction, W_f , is defined by the equation:

$$W_f = \frac{2Rr dt}{W_o}$$

where r is the burning rate, R is the burning rate conversion factor, and W_o is the original web thickness. The factor of two is present since the web is being burned from two opposite surfaces and R is included to compensate for burning rate peculiarities. The amount of gas generated can be found as a function of W_e by the following two equations:

$$\frac{G}{C} = f(W_i) = K_0 + K_1 W_i + K_2 W_i^2 = K_3 W_i^3 \text{ if } W_i \geq 0$$

$$\frac{G}{C} = f(W_i) = K_0 + K'_1 W_i + K'_2 W_i^2 + K'_3 W_i^3 \text{ if } W_i \leq 0.$$

where G is the mass of gas generated, C is the original charge mass, K_0 - K_3 and K'_1 - K'_3 are coefficients determined by the grains geometry and W_i is the fraction of web remaining. The first equation is employed during non-splintered burning ($W_i \geq 0$) and the second is used after grain splintering has occurred ($W_i < 0$). Slivering is typical of multi-perforation grain types. In these grain types there is residual propellant when the web fraction is burned to zero. This remaining propellant is then burned as slivers. In simulations containing more than one grain type, each granulation is handled separately. The total gas generated is simply their sum.

(3) As propellants burn, the total energy available from a unit mass of propellant can be computed by the equation:

$$E = \frac{FG}{g-1}$$

where E is the energy liberated, G is the ratio of specific heats of the propellant gas, F is the propellant impetus

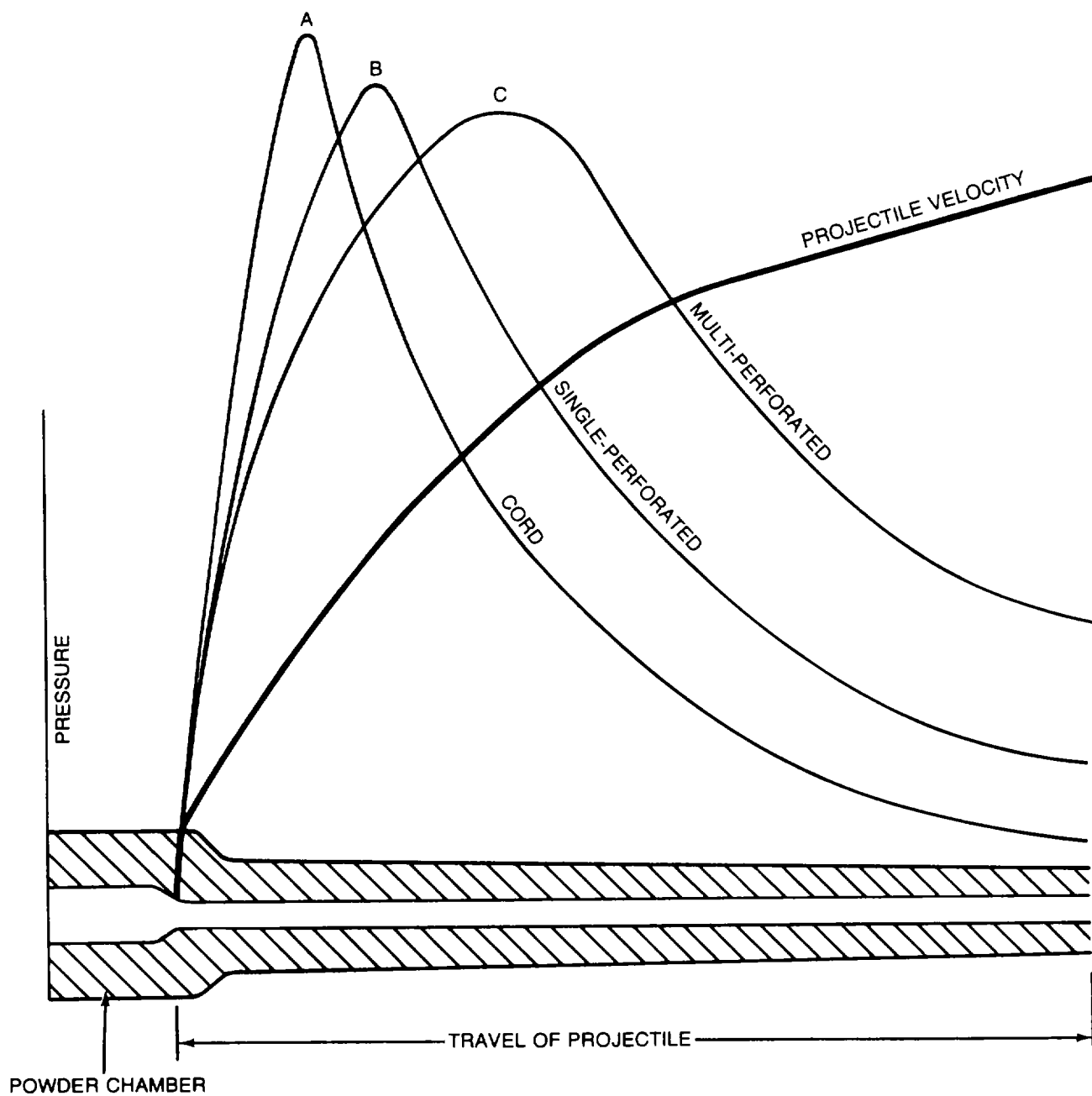

Figure 9-3. Pressure travel curves for a projectile in a gun.

(the amount of energy per unit mass). In cases where more than one grain type or more than one propellant type are used, the energy generated by each distinct granulation-propellant combination is calculated separately and summed to compute the total energy released. The energy released by the burning propellants is dissipated in several ways. The potential energy of the confined gas is increased (PV energy). Energy is spent accelerating the projectile and the gas itself (kinetic energy). Energy is lost through thermal and frictional processes which results in an increase of the gas temperature. The energy balance equation is

$$\frac{PE}{\gamma-2} = E - (0.5M_{eff}V^2)(1+B_f)$$

where PE is the potential energy of the confined gas, E is the total energy released by the propellants, M_{eff} is the effective mass of the projectile and gases, B_f is the energy loss coefficient, V is the velocity of the projectile, and γ is the specific heat ratio of the propellant gas. The effective mass used in this calculation is given by the equation:

$$M_{eff} = W_t \cdot CF_3 \cdot M_p$$

where W_t is a correction for projectile twisting, CF_3 is a Piddock-Kent coefficient, and M_p is the projectile mass. The factor W_t is included since the projectile is undergoing rotational acceleration in addition to linear acceleration. W_t is normally set at 1.02 which provides an excellent approximation.

(4) Projectile motion is determined by the application of Newton's third law

$$a = \frac{P_b A}{M_p}$$

where a is the projectile's acceleration, P_b is the base pressure, A is the bore cross sectional area, and M_p is the projectile's mass. The velocity and position may be obtained by integrating this expression one and two times, respectively with respect to time.

b. Several computer programs are used to perform interior ballistic calculations. One such program is the Interior Ballistic Interactive Simulation (IBIS) code. IBIS computes propellant charge weight, web dimensions, and grain dimensions from the pressure parameters of the cannon, projectile weight, muzzle velocity, bore cross sectional area, force of the propellant, and burning rate of the propellant.

9-11. Sensitivity. The colloidal structure of propellants reduces sensitivity to a point well below that of the

individual ingredients, nitroglycerin and/or nitrocellulose. From a practical standpoint, the hazards associated with a propellant are mainly heat, spark, and very high energy impact.

a. To a great extent, the degree of confinement determines whether a propellant will deflagrate or detonate. Experiments have shown that the confinement afforded by the upper part of a column of propellant may be sufficient to cause explosion if the powder at the bottom of the pile is ignited. Various powder compositions were found to have correspondingly varying critical heights of column, the critical height varying inversely with the energy content of the composition. For the same composition, the critical height was found to vary directly with the average web of the powder. If the temperature of the powder is 50°C instead of 20°C, the critical height of a composition is only 30 to 50 percent as much as at the lower temperature. Propellants for small arms, chiefly nitrocellulose, were found to have critical height values of 38.1 to 50.8 centimeters. Single based cannon powders of larger grain sizes and containing moderants have critical height values of 76.2 centimeters or more. Propellants can be detonated by initiating compounds or booster explosives.

b. Propellants are sensitive to electric sparks only if the material is in the form of a dust. Some test results indicate the powder dust is much more ignitable by a static electricity spark than is nitrocellulose. Dry-house and blending-towerfires have occurred that were attributed to the primary ignition of powder dust by static electricity sparks. Atmospheric relative humidity above 60 percent prevents such spark discharges and ignitions. The humidity must be measured where the operation is going on.

c. Propellants can be ignited by the friction and impact of small arms bullets. Detonation or deflagration occurs according to confinement. Recently a great deal of attention has been placed on very high kinetic energy impacts such as the impact of a shaped charge jet spall. These concerns are obviously from the standpoint of practical application.

9-12. Stability. The stability of nitrocellulose, which was discussed in Chapter 8, is relatively poor. The stability of nitrocellulose based propellants is correspondingly poor. The degradation of nitrocellulose proceeds by two chemical reactions. In the first degradation reaction, nitrocellulose loses nitrogen oxides. The loss of nitrogen oxides

is an intrinsic tendency of the nitrocellulose molecule. The reaction rate varies with the temperature, but even at low temperatures the loss of nitrogen oxides occurs. In the second degradation reaction, which occurs initially as a result of the first, the nitrogen oxides that are formed attack the nitrocellulose molecule. The reaction between the nitrocellulose and nitrogen oxides produces more nitrogen oxides. The increased number of nitrogen oxides and increased temperature cause the reaction rate to accelerate. After a few years the reaction rate in samples of sufficient size is so fast that the propellant self-heats above the flame point and will self-ignite. Nothing can be done to stop the first degradation reaction. The second degradation reaction is controlled by two means. The heat of reaction is dissipated by a suitable heat sink, for example the metal case of a cartridge is an excellent thermal conductor. This does not solve the problem totally, however, if the diameter of the cartridge case exceeds 3 inches. The second, and most effective, means of controlling the degradation reaction is to include a chemical stabilizer in the propellant composition. A stabilizer has a greater affinity for the nitrogen oxides than nitrocellulose, and so absorbs them before they can attack the nitrocellulose molecule. This reduces the rate of propellant decomposition to about that of the first degradation reaction. However, the stabilizer is consumed as it absorbs nitrogen oxides. Therefore the increase in time the propellant will remain stable is directly proportional to the amount of stabilizer added. Some propellants can be stabilized in this manner for 30 or 40 years. Three stabilizers are of interest for military applications in the United States; diphenylamine (DPA), ethyl centralite (EC), and the akardites (AK). DPA is used in single-base propellants but is incompatible with nitroglycerin and so cannot be used in double-base and triple-base compositions. EC or 2-NDPA is used for double and triple-base propellants which use nitroglycerin as the gelatinizing agent for the nitrocellulose. Akardites are used in propellants that contain DEGN rather than nitroglycerin.

a. Diphenylamine, $(C_6H_5)_2NH$, is an ammonia derivative in which two of the hydrogens have been replaced by phenyl groups. Each phenyl ring has three hydrogens which can be replaced with nitro groups. Therefore, DPA can be nitrated to the hexanitrate by absorbing the nitrogen oxides produced during the decomposition of nitrocellulose. DPA is nitrated relatively easily and the reaction is not exothermic. During the decomposition of nitrocellulose, DPA nitrates to the following compounds in succession.

N-nitrosodiphenylamine
 2-nitrodiphenylamine
 4-nitrodiphenylamine
 N-nitroso-2-nitrodiphenylamine
 N-nitroso-4-nitrodiphenylamine
 4,4', 2,4', 2,2', and 2,4-dinitrodiphenylamines
 N-nitroso-4, 4'-dinitrodiphenylamine
 N-nitroso-2, 4'-dinitrodiphenylamine
 2, 4, 4' and 2, 2', 4-trinitrodiphenylamines
 2,2', 4,4'-tetranitrodiphenylamine
 2,2', 4,4', 6-pentanitrodiphenylamine
 Hexanitrodiphenylamine

The propellant does not start to become unstable until most of the diphenylamine has been converted to hexanitrodiphenylamines. A very accurate test to measure the remaining safe storage life in a propellant lot is to analyze the distribution profile of the nitro DPAs. Only about one percent DPA can be added to a propellant because its nitrated products change the ballistic properties.

b. Centralite I (which is also called ethyl centralite or symmetrical diethyldiphenylurea), $OC [N-(C_2H_5)(C_6H_5)]_2$, was developed in Germany for use in double base propellants. The compound acts as a stabilizer, gelatinizer, and waterproofing agent. Unlike diphenylamine, centralite can be used in relatively large proportions and some propellant compositions contain as much as eight percent of this material. Like diphenylamine, centralite is nitrated by the products of nitrocellulose decomposition. The following compounds are formed successively, as many as four being present simultaneously, as deterioration of the powder proceeds.

4-nitrocentralite
 4,4' dinitrocentralite
 N-nitroso-N-ethylaniline
 N-nitroso-N-ethyl-4-nitraniline
 2,4, dinitro-N-ethyl-aniline

Centralite II (which is also called methyl centralite or symmetrical dimethyl diphenylurea), $OC[N(CH_3)(C_6H_5)]_2$, also has been used as a stabilizer but is not considered to be as effective as the ethyl analogue.

c. Three akardites, or acardites, are used to stabilize propellants. Their structure is shown in figure 9-4. Akardite II is often used in DEGN containing propellants.

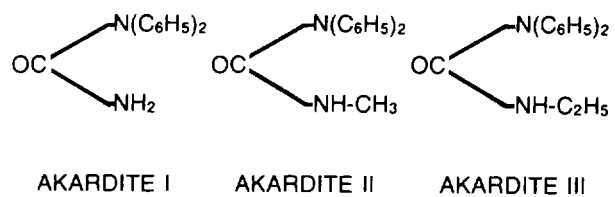

Figure 9-4. Akardites.

CHAPTER 10 UNITED STATES PYROTECHNICS

10-1. Categories of Pyrotechnic Devices.

a. *General.* All pyrotechnic compositions contain oxidizers and fuels. Additional ingredients present in most compositions include binding agents, retardants, and waterproofing agents. Ingredients such as smoke dyes and color intensifiers are present in the appropriate types of compositions.

(1) Oxidizers are substances in which an oxidizing agent is liberated at the high temperatures of the chemical reaction involved. Two oxidizing agents, oxygen and fluorine, are currently used in pyrotechnic compositions. Oxygen is provided by the nitrates of barium, strontium, sodium, and potassium, the perchlorates of ammonium and potassium, or the peroxides of barium, strontium, and lead. Use of a specific oxidant is determined by the desired burning rate, luminosity, and color. Fluorine is usually provided by polytetrafluoroethylene or chlorotrifluoroethylene. Pyrotechnic compositions do not usually contain a stoichiometric proportion of oxidizer, the balance of the requirement for fuel oxidation is provided by atmospheric oxygen.

(2) Fuels include finely powdered aluminum, magnesium, metal hydrides, red phosphorus, sulfur, charcoal, boron, silicon, and suicides. The most frequently used are powdered aluminum and magnesium.

Additional materials such as binding agents, waterproofing agents, and color intensifiers also act as fuels.

(3) Binding agents include resins, waxes, plastics, and oils. These materials make the finely divided particles adhere to each other when compressed into pyrotechnic items. They also prevent segregation and ensure a more uniformly blended composition. Binders also help to obtain maximum density and increased burning efficiency. In addition, they serve, in some cases, to reduce the sensitivity of compositions that otherwise would be unduly sensitive to shock and friction.

(4) Retardants are materials that are used to reduce the burning rate of the fuel-oxidizing agent mixture, with a minimum effect on the color intensity of the composition. Some retardants act only as inert

diluents, while others take part in the combustion reaction at a much slower rate than the metallic fuels. Calcium carbonate, sodium oxalate, strontium resinate, titanium dioxide, polyvinyl chloride, ethyl cellulose, paraffin, linseed oil, castor oil, asphaltum, and sulfur are the most important retardants used. Certain of these serve other purposes as well. For example, sodium oxalate and polyvinyl chloride act also as color intensifiers, titanium dioxide is a source of incandescent solid particles in the flame produced by the composition, and the waxes and oils act as fuels, binding agents, and waterproofing agents as well as retardants.

(5) Waterproofing agents are necessary in many pyrotechnic compositions because of the susceptibility of metallic magnesium to reaction with moisture, the reactivity of metallic aluminum with certain compounds in the presence of moisture, and the hygroscopicity of nitrates and peroxides. Waterproofing agents are applied as a coating on metallic fuels, such as a coating of dried linseed oil on magnesium, or as an ingredient uniformly distributed throughout the rest of the composition. In some cases, the metallic fuel is given a coating by treatment with a solution of acidic or acidified potassium dichromate. Waxes, resinates of metals, and natural and synthetic resins are used for distribution throughout the composition. Many of these serve also as binding agents.

(6) Color intensifiers are highly chlorinated organic compounds such as hexachloroethane (C_2Cl_6), hexachlorobenzene (C_6Cl_6), polyvinyl chloride, and dechlorane ($C_{10}Cl_{12}$). These agents are effective because of their decomposition during combustion and the formation of metallic chlorides which produce characteristic color bands in the flame spectrum. The portion of the intensifier other than chlorine acts as a part of the fuel in the composition. Since they are less reactive than metallic fuels, color intensifiers act to some extent as retardants of combustion. Certain intensifiers such as polyvinyl chloride, because of their physical characteristics, can serve also as binding agents.

(7) Smoke dyes are azo and anthraquinone dyes. These dyes provide the color in smokes used for signaling, marking, and spotting.

b. *Flares and Signals.*

(1) The illumination provided by a flare is produced by both the thermal radiation from the product oxide particles and the spectral emission from excited metals. The human eye is more sensitive to the frequencies produced by sodium, so sodium nitrate is usually chosen as the oxidant. The composition of illuminating flares falls in the range of 53 to 58 percent magnesium, 36 to 40 percent sodium nitrate, and four to eight percent binder. Aluminum may also be used as a fuel. The three qualities which are useful in describing the performance of flares are intensity, illuminance, and light efficiency. The intensity (I), expressed in candelas is determined experimentally. The intensity of a flare is largely determined by the combustion temperature which depends on the stability of the products. 3000°K should be exceeded to accommodate the spectral sensitivity of the human eye. Illuminance (E), expressed in lumens per square meter, depends on the distance of the flare from the features that are to be illuminated. The approximate equation for illuminance is:

$$E = I h (r^2 + h^2)^{-3/2}$$

where h is the height of the flare above the ground and r is the radius of illumination. Light efficiency (C), expressed in lumens per watt, is the light output per unit energy in terms of the heat of reaction of the flare mixture burning in air. The approximate equation for lighting efficiency as a function of time is

$$C = 4I t / Q m$$

where Q is the heat of reaction, m is the mass of the mixture, and t is the time. The volumetric efficiency of a flare is the radiant energy per steradian per unit flare volume which is expressed in watt seconds per steradian cubic centimeter. A full description of a flare is given by the volumetric efficiency, burning time, and spectral distribution. Infrared flares are used with a scanning device such as a low light level television or image intensifier. These flares use metals with peak spectral emissions in the infrared rather than sodium. Table 10-1 lists the composition of some infrared flare mixtures as a function of the wave length of the light emitted. A special type of flare is a thermal decoy which has a strong infrared emission. One of the reactions utilized in decoys is the reaction between magnesium and a fluorocarbon such as polytetrafluorethylene. Hot carbon particles are formed which provide infrared emissions.

Table 10-1. Infrared Flare Formulas

Component	Wavelength emitted in micrometers		
	0.76	0.79	0.8 - 0.9
Silicon (%)	10	10	16.3
KNO ₃ (%)	70	-	-
CsNO ₃ (%)	-	-	78.7
RbNO ₃ (%)	-	60.8	-
Hexamethylene tetramine, (%)	16	23.2	-
Epoxy resin, (%)	4	6	5

(2) Signal flares are smaller and faster burning than illuminating flares. Various metals are added to these compositions to control the color of the flame.

Combinations of metals may also be used to prevent enemy imitation of flare sequences. One example is the red-green flare. The composition is given in table 10-2.

Table 10-2. Red-Green Flare System, Parts by Weight

Barium nitrate	30
Strontium nitrate	13
Potassium perchlorate	9
Magnesium	30
Dechlorane	12
Polyvinyl acetate resin	4

The color of the flare is different when viewed through a filter than when viewed without a filter. Unfiltered, the green and red lights combine to form a yellow light which resembles the color of a pure yellow flare.

c. *Colored and White Smoke.*

(1) The pyrotechnic generation of smoke is almost exclusively a military device for screening and signaling. Screening smokes are generally white because black smokes are rarely sufficiently dense. Signal smokes, on the other hand, are colored so as to assure contrast and be distinct in the presence of clouds and ordinary smoke. Smoke has also been found to aid the daytime observance of tracer projectiles and also for tracking space vehicles during launch. Whereas smokes are often characterized by the mode of their formation, any concentrated suspension of particles ranging from 0.01 to about 5.0 micrometers can be considered a smoke. These particles, when suspended in air, reflect, scatter and absorb radiation. The following are pyrotechnic methods for smoke generation as opposed to mechanical methods such as atomization of fog oil, of titanium tetrachloride (FM smoke), or of sulfur trioxide.

(a) Venturi thermal generator type. The smoke producing material and the pyrotechnic fuel block required to volatilize the smoke material are in separate compartments. The smoke producing material is atomized and vaporized in the venturi nozzle by the hot gases formed by the burning of the fuel block. An example of this type smoke generator is the oil smoke pot which is powered by a slow burning, gassy pyrotechnic mixture such as ammonium nitrate and ammonium chloride with a small amount of carbonaceous fuel. The resulting gas jet pulls a stream of oil from a reservoir and injects it into a venturi where the formation of the aerosol takes place.

(b) Burning type. Burning type smoke compositions are intimate mixtures of chemicals. Smoke is produced from these mixtures by either of two methods. In the first method, a product of combustion forms the smoke or the product reacts with constituents of the atmosphere to form a smoke. In the second method, the heat of combustion of the pyrotechnic serves to volatilize a component of the mixture which then condenses to form the smoke. White phosphorus, either in bulk or in solution, is one example of the burning type of smoke generator. The resulting colloidal suspension of phosphorus pentoxide is quickly hydrolyzed by moisture to become phosphoric acid droplets which are the actual visible constituent of the smoke. Various other burning type smoke generators exist such as those used for signaling purposes and those which use red phosphorus, metallic phosphides, or phosphorus trichloride as the source of the particulate cloud. Another important burning type of smoke generator is the HC smoke mixture which has been prepared with a number of combinations of zinc with a chlorine carrier to form, on combustion, zinc chloride. For example,

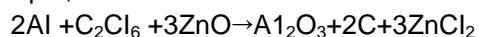

(c) Explosive dissemination type. The smoke producing material is pulverized or atomized and then vaporized, or a preground solid is dispersed by the explosion of a bursting charge. The explosive dissemination smoke generator may contain metallic chlorides which upon dispersal, hydrolyze in air. Examples are titanium, silicon, and stannic tetrachloride. An effective smoke agent, whether mechanically dispersed from an aircraft spray tank or vaporized thermally, is a mixture of sulfur trioxide and chlorosulfonic acid (FS smoke agent) which upon hydrolysis forms sulfuric and hydrochloric acid dispersions. Of course, all such formulations are highly corrosive, and, if not outright toxic, then conducive to pulmonary edema. The so-called standard smoke is a smoke of such a density that a light of 25 candela

intensity is just invisible when observed through a layer of approximately 30 meters. The amount of smoke agents required to produce one cubic meter of standard smoke is given in table 10-3.

Table 10-3. Amount of Smoke Agent per Cubic Meter of Standard Smoke

Material	Grams per cubic meter
White phosphorus	0.064
Sulfur trioxide	0.099
FS agent	0.116
HC mixture	0.127
FM agent	0.159
Crude oil	2.11

(2) The preferred method of dispersing colored smokes involves the vaporization and condensation of a colored organic volatile dye. The problem has always been one of selecting dyes which are thermally stable and which vaporize without decomposition at temperatures below 400°C. There are a very large number of dyes. The following are representative of dyes selected by the US as satisfactory agents for producing burning type colored smokes:

- Yellow: Auramine hydrochloride
- Green: 1,4-Di-p-toluidinoanthraquinone with auramine hydrochloride
- Red: 1-Methylantraquinone
- Blue: Not suitable for signaling because of excessive light scatter.

These dyes are mixed to the extent of about 50 percent with a fuel such as lactose (20 percent) and an oxidizer (30 percent) for which potassium chlorate is preferred. If the mixtures should still burn too hot (and thereby destroy the dye), sodium or potassium bicarbonate are added as cooling agents. Colored smoke compositions are usually used in a compressed state without a binder. A major concern at present is the reported carcinogenic nature of organic dyes and elaborate programs have been initiated for their destruction. In addition to the smoke grenades which function by burning, others produce smoke by volatilization of the dye from a separate dye compartment. These dyes should preferably have melting points below 150°C and be stable in the vapor phase. The following are currently used dyes:

- Orange: 1-(4-Phenylazo)-2-naphthol
- Yellow: N, N-Dimethyl-p-phenylazoaniline
- Blue: 1,4-Diamylaminoanthraquinone

Mixtures of these dyes produce muddy colors of various hues. Lastly, dyes can be dispersed by explosive charges. These generate colored clouds (about 10 x 20m) which are formed instantaneously and which have a life expectancy, depending on environmental conditions, from 65 to 85 seconds, whereas aerial burning of the aforementioned burning type produces streamers about one meter across which last for about 57 to 120 seconds.

d. *Tracers and Fumers.* The principal small arms application of military pyrotechnics is in tracer munitions where they serve as incendiaries, spotters, and as fire control. Two types of tracers are used. The difference

between the two types is the method of tracking. The more frequently used tracer uses the light produced by the burning tracer composition for tracking. Smoke tracers leave a trail of colored smoke for tracking. Red is the flame color most often employed in tracers. Red has a longer wavelength and so can penetrate haze, dust, and fog better than the other colors. A tracer may be directly ignited by the flame from a propellant charge or, as is the case in larger caliber shells, the ignition may be delayed to hide the position of a cannon. Table 10-4 lists several tracer and delay compositions.

Table 10-4. Typical Formulas for Igniter and Tracer Compositions

Ingredient (%)	Delay action igniter 1-136	Dim igniter 1-194	Daylight (bright) igniter 1-276	Red tracer R-257	Fumer R-284
Strontium peroxide	90	-	-	-	-
Magnesium	-	6	15	28	28
1-136 Igniter	-	94	-	-	-
Calcium resinate	10	-	-	4	-
Barium peroxide	-	-	83	-	-
Zinc stearate	-	-	1	-	-
Toluidine red (identifier)	-	-	1	-	-
Strontium nitrate	-	-	-	40	55
Strontium oxalate	-	-	-	8	-
Potassium perchlorate	-	-	-	20	-
Polyvinyl chloride	-	-	-	-	17

Compositions have also been developed for electro-optical devices. These compositions consist of calcium resinate, barium and strontium peroxides, and magnesium carbonate. The mechanism of tracer reactions is a complex one; the burning rate and brightness decrease with altitude but increase with increasing spin rate of the bullet. Smoke tracer compositions contain about 70 percent strontium peroxide, 10 percent calcium resinate, 10 percent catechol, and 10 percent smoke dye. Methylaminoanthraquinone is the dye used in red smoke and auramine is used for greenish-yellow smoke. A fumer, or gas generating tracer, uses the gaseous products of the burning tracer to fill the vacuum created behind the moving projectile. This increases range and decreases time of flight.

e. *Incendiaries.* Two types of incendiaries are commonly used. The traditional type is a bomb containing a flammable material. These materials include thermite (a mixture of aluminum and rust),

phosphorus, and napalm. In addition, the case of the bomb may be constructed of a material such as magnesium that will burn at a high temperature once ignited. The burning material may be explosively scattered over a wide area. The more recently developed type of incendiary uses metals which produce pyrophoric, or burning, fragments. Three properties have been identified as important for metals which are suitable for use as incendiaries. The heat of formation of the oxide must be greater than 400 kilojoules per mole of oxygen consumed. The ratio of the oxide volume to metal volume must be greater than one.

The metal must also have electrons in the conduction band. Formation of an intermetallic compound that reduces the number of electrons in the conduction band reduces the pyrophoricity of the compound. Table 10-5 lists the properties of metals considered suitable for incendiary use.

Table 10-5. Properties of Pyrophoric Metals

Metal	Heat of oxide formation (per mole of oxygen)	Oxide volume/ metal volume	Electronic structure
U	-536	3.10	6d ¹ 7s ¹
Th	-587	1.36	6d ² 7s ²
Zr	-512	1.55	4d ² 5s ²
Hf	-577	1.62	5d ² 6s ²
Ce	-486	1.23	5d ⁰ 6s ²
La	-641	1.11	5d ¹ 6s ²
Pr	-621	1.12	5d ⁰ 6s ²
Nd	-617	1.12	5d ⁰ 6s ²
Sm	-431	1.06	5d ⁰ 6s ²
Y	-427	1.44	4d ¹ 5s ²
Ti	-426	1.78	3d ² 4s ²

For straight incendiary applications the sponge form of these metals is used because this form provides a large surface area. Metals which are used in this application include zirconium, titanium, and mischmetal. Polytetrafluoroethylene can be used as an oxidizing agent. The heat of the reaction for several metals is shown in table 10-6. The numerical values given are strongly affected by the stoichiometry and the effective density of the reactants.

Table 10-6. Maximum Volumetric Heats of Reaction for Metals Reacting with Fluorocarbons

Metal	Product	Kilojoules per cubic centimeter
Be	BeF ₂	-24.0
La	LaF ₃	-21.0
U	UF ₃	-19.8
Mg	MgF ₂	-19.8
Hf	HfF ₃	-19.0
U	UF ₄	-18.9
Zr	ZrF ₃	-18.6
Zr	ZrF ₄	-18.6
Hf	HfF ₄	-18.2
Ti	TiF ₃	-17.0
Ti	TiF ₄	-14.6

Depleted uranium is used extensively in pyrotechnics which have armor piercing capabilities. Depleted uranium deficient in the more radioactive isotope U235, is the waste product of the uranium enrichment process. The depleted uranium is formed into projectiles that can penetrate armor because of their high density and mechanical properties. The impact of the projectile causes the uranium to form many pyrophoric fragments which can ignite fuel and munition items.

f. Delays and Fuses. Delay compositions are mixtures of oxidants and powdered metals which produce very little gas during combustion. Work on delay systems continues because the existing delay mixtures do not store well and scale-up is not as flexible and as precise as is desired. A basic reason is that gasless delay mixtures are not truly gasless because gaseous reagents are present in the flame front or in the ignition mix. The gaseous reagents contribute to the pressure in the column so that the burn time is not strictly a linear function of the column length. This phenomenon has been called the anticipatory effect. Table 10-7 lists the most important delay compositions in use at the present time.

Table 10-7. Delay Compositions

Mixture	Illustrative Composition		Burn time range centimeters per second	Temperature coefficient %/°K	Delay time change on storage in seconds per year per centimeter
D-16	Mn	29%	0.8 - 5.4 (obtured)	0.17	0.02
	PbCrO4	26%			
	BaCrO4	45%			
T-10	B	3 - 15%	0.23 - 0.32 (obtured)	0.23 - 0.32	0.15 - 0.38
	BaCrO4	97 - 85%			
Zr-Ni Delays	Ni-Zr	26%	0.8 for 70/30 Zr-Ni, 4.6 for 30/70 Zr-Ni, 7.8 with CeO2 (vented)	0.16	0.06
	BaCrO4	60%			
	KC104	14%			
	Up to 10°/o	CeO2			
Tungsten- Viton	W	30%	Approximately 0.8 - 6.2 (vented)	0.1	Not known, not suitable for storage in high humidity
	BaCrO4	55%			
	KC104	10%			
	Diatomaceous earth	4%			
	Viton	1%			
UMNOL Tungsten Delay	W	30%	0.04 - 16 Up to 24 with CaF2 (vented)	0.1	Sensitive to moisture
	BaCrO4	55%			
	KC104	10%			
	Diatomatceous earth	50/o			

The delay time change, or aging, is caused by the corrosion of the metallic fuels. The rate of corrosion is increased by the presence of moisture. In general the burn time of the delay is adjusted within stated limits by controlling the percentage of fuel in the composition. The chromate oxidizers may be carcinogenic.

g. Photoflash Compositions. Photoflash compositions are the single most hazardous class of pyrotechnic mixtures. The particle size of the ingredients is so small that burning resembles an explosion. The various photoflash devices are similar, differing principally in size and the amount of delay. When fired, each photoflash cartridge, after one, two, or four seconds, produces a flash having a peak intensity of approximately 50 million candela with a total output of five million candela seconds, whereas photoflash bombs generate above 5×10^9 candela. The most commonly used fuels include aluminum and magnesium. The most commonly used oxidizers include barium nitrate and potassium perchlorate. While atomized magnesium gives higher intensities in consolidated compositions, atomized aluminum performs better in loose compositions than do other fuels. Potassium perchlorate produces the highest heat of reaction with atomized aluminum. The output is highest for fuel rich compositions and alkaline earth nitrates which are far superior to alkali metal nitrates. Constant aluminum particle sizes of 22 ± 8 micrometers resulted in optimum efficiency at all altitudes. At high altitudes zirconium performs better. Photoflash compositions containing hafnium and potassium perchlorate possess greater luminous efficiency on a volume basis than do other formulations. Zirconium, for example, when burned in oxygen has an average color temperature of 4,883°K compared with 5,235°K for hafnium at peak intensity. In pyrotechnic flash units, substitution of aluminum with hafnium and titanium produced comparable peak output, but inferior output when zirconium and cesium were substituted.

h. Igniters and Initiators. Black powder is used extensively as an igniter for artillery propellant charges. Table 10-8 lists various black powder compositions used by the United States.

Table 10-8. Black Powders Used in Pyrotechnics

Components (%)	Formulas		
	146	147	148
Potassium nitrate	74.0	70	-
Sodium nitrate	-	-	72
Charcoal	15.6	-	16
Coal (semibituminous)	-	14	-
Sulfur	10.4	16	12

order detonation. Coarse unpressed powders which are confined have approximate burning rates of 170 meters per second. Fine, unpressed, confined powders have burning rates of approximately 950 meters per second. A newer formulation of black powder called pyrodex consists of six percent sulfur, 10 percent charcoal, 83 percent potassium nitrate, and one percent calcium carbonate. This mixture has an ignition temperature above 260°C compared with 125°C for regular black powder. Other mixtures called either first fire, ignition mixtures, or starters are used. The names are somewhat misleading. The mixtures are intermediates between the primary igniter and main charge. Table 10-9 lists some of the numerous formulations of this type mixture.

A small amount of graphite is added as a glazing during the finishing process. The burning rate of black powder is dependent on the granulation of the ingredients and the grain size. The burning can be described as low

Table 10-9. Ignition Mixtures.

Components, %	Formulas																
	60	68	69	164	165	173	174	175	176	177	178	179	180	181	182	183	184
Aluminum (powdered)	-	-	-	-	-	-	-	-	-	40.0	-	-	-	-	35.0	20.0	-
Ammonium dichromate	-	-	-	-	10.5	-	-	-	-	-	-	-	-	-	-	-	-
Asphaltum	-	-	-	-	-	2.0	-	-	-	-	-	-	-	-	-	-	-
Barium chromate	-	-	-	-	-	-	-	-	-	-	-	-	90.0	-	-	-	-
Barium peroxide	-	-	-	-	-	78.0	80.5	4.0	79.0	31.0	91.0	-	-	-	-	-	-
Boron (amorphous)	-	-	-	-	-	-	-	-	-	-	-	-	10.0	-	-	-	23.7
Calcium resinate	-	-	-	-	-	-	2.0	-	-	-	-	-	-	-	-	-	-
Charcoal	-	-	-	6.0	-	-	-	-	-	-	-	-	-	-	-	-	-
Diatomaceous earth (See also superfloss)	10	-	-	-	-	-	-	-	-	-	-	-	-	-	-	-	-
Fe ₂ O ₃ (Red)	49	-	-	-	5.0	-	-	-	-	-	-	50.0	-	25.0	-	-	-
Fe ₃ O ₄ (Black)	-	-	-	-	-	-	-	-	-	29.0	-	-	-	-	-	-	-
Potassium nitrate	-	-	-	-	-	-	-	-	-	-	-	-	-	-	-	-	70.7
Potassium perchlorate	-	-	-	-	74.0	-	-	-	-	-	-	-	-	-	64.0	63.0	-
Laminac	-	-	-	-	-	-	-	-	-	-	-	-	-	-	-	-	5.6
Magnesium (powdered)	-	-	-	-	-	-	-	-	-	-	9.0	-	-	-	-	-	-
Sodium nitrate	-	-	-	47.0	-	-	-	-	-	-	-	-	-	-	-	-	-
Nitrocellulose	-	-	-	-	10.5	-	-	-	-	-	-	-	-	-	-	-	-
Parlon (chlorinated rubber)	-	-	-	-	-	-	-	-	5.6	-	-	-	-	-	-	-	-
PbO ₂	-	80	60	-	-	-	-	-	-	-	-	-	-	-	-	-	-
Pb ₃ O ₄	-	-	-	-	-	20.0	17.5	25.0	14.0	-	-	-	-	-	-	-	-
Sr peroxide	-	-	-	-	-	-	-	70.0	-	-	-	-	-	-	-	-	-
Sugar	-	-	-	47.0	-	-	-	-	-	-	-	-	-	-	-	-	-
Superfloss	-	-	-	-	-	-	-	-	-	-	-	-	-	-	-	-	-
Titanium	-	-	-	-	-	-	-	-	-	-	-	32.5	-	10.0	-	-	-
Toluidine red toner	-	-	-	-	-	-	-	-	0.5	-	-	-	-	-	-	-	-
Vegetable oil	-	-	-	-	-	-	-	-	-	-	-	-	-	-	1.0	-	-
Vistanex (polyisobutylene)	-	-	-	-	-	-	-	-	-	-	-	-	-	-	-	-	4.0
Zinc Stearate	-	-	-	-	-	-	-	1.0	0.9	-	-	-	-	-	-	-	-
Zirconium	41	20	40	-	-	-	-	-	-	-	-	17.5	-	65.0	-	-	-

i. Simulator Compositions. Simulator compositions are used to simulate the functioning of ammunition items during training exercises. Simulators can harmlessly duplicate the effects of air bursts, boobytraps, ground bursts, gunflashes, and hand grenades. Simulators which must produce a loud noise may use black powder or such compositions as a mixture of aluminum powder, potassium perchlorate, and barium nitrate. These simulators also produce white smoke. Grey or black smoke can be produced by carbon rich compounds such as naphthalene which do not oxidize completely. Simulators can also contain colored smoke compositions for marking the positions of certain types of hits such as chemical or incendiary projectile impact. Some simulators contain a pyrotechnic whistle. Picric acid and such other organic acids as gallic, salicylic, and benzoic having the same characteristic odor, are the major ingredients in pyrotechnic whistles. Combinations of these acids with potassium chlorate, perchlorate, or nitrate, compressed in short tubes, emit a shrill whistling sound of varying pitch when ignited. Size, especially length of the tube in which the composition is pressed, determines pitch.

10-2. Manufacturing of Pyrotechnics.

a. Storage. Care must be exercised in the storage and handling of pyrotechnics and pyrotechnic ingredients. Small quantities of contaminants can cause changes in stability and burning rates which lead to inconsistency in performance.

b. Grinding. The particle size of the ingredients is extremely important in pyrotechnic compositions. Three methods are used to grind the particles to the proper size. One method is with a hammer mill. A hammer mill consists of a series of hammers which rotate at high speeds. The impact of the hammers grinds the material. Some heat sensitive material such as waxes or resins may be cooled with dry ice or liquid nitrogen before being processed by the hammer mill. Materials which cannot be ground safely in a hammer mill are ground in a ball mill. In the ball mill the sample is placed in a sealed drum with a large number of steel, brass, or ceramic balls. The drum is rotated. The tumbling of the balls grinds the material. The third method of grinding, an attrition mill, is used to further reduce the size of the particles of powder. In the

attrition mill a stream of high velocity air is used to accelerate particles of the powder. The collisions of the particles with one another break them down further.

c. Classification. After grinding, the powders are classified by size. For powders above 44 microns, sieves are used. For powders below 44 microns, cyclones are used. Cyclones are funnel shaped chambers into which the powder is fed. An air current is maintained which centrifugally separates the powders by size. The coarser materials are forced to the wall of the container.

d. Weighing. To obtain the proper performance from a pyrotechnic composition accurate weighing is necessary.

e. Blending. Two methods are used for the blending of pyrotechnic compositions, dry and wet. The dry method is used for insensitive material. Passing the ingredients through sieves is used for small quantity production. A ball mill which uses rubber balls is used for larger quantities. Wet mixing is accomplished with the ingredients suspended in a liquid. This method is used to blend more sensitive materials.

f. Granulation. In order to ensure the pyrotechnic composition is sufficiently fluid after blending, the mixture is forced manually through a sieve. An alternate method is to press the composition into a cake and then granulate the cake.

g. Loading. Loading pyrotechnic compositions is accomplished by means of a press. Special tools support the element into which the composition is being loaded. Multiple layers of different types of composition are loaded by multiple pressing operations.

h. Drying. Drying is accomplished by subjecting the ingredients to 105° to 110°C for two to four hours. Vacuum drying may be necessary to further reduce moisture content.

i. Assembly. The pyrotechnic item is now ready for assembly into the end item. Care should be taken to prevent exposure to moisture and ensure the pyrotechnic item is properly supported for transportation.

10-3. Testing. The different types of tests used in the process of developing pyrotechnic ammunition are described in this paragraph.

a. *Kinds of Tests.*

(1) Development tests. Development tests are performed by the designing agency to ensure that component subassemblies or complete ammunition function in the manner for which they were designed. These tests evaluate the latest efforts of the designer and may be repeated until successful results are obtained. The ammunition is subjected to a series of tests that serve to determine that the device is safe and reliable, and to ascertain readiness for field testing and use. Part of the task of planning an ammunition development project is to specify the type of test, the order of execution, and other testing details. Development tests are usually made in the laboratory or developer's testing facility, and need not include all of the parts of the complete device.

(2) Evaluation. Evaluation tests are made to assess the usefulness of a pyrotechnic system. These tests expose the characteristics of the hardware to observation by personnel experienced with pyrotechnic applications. An evaluation of a flare launcher, for example, includes describing the launcher, evaluating projected altitude, illumination duration, effects of water soaking, day and night range functioning, ability to penetrate foliage, and comparing .38 and .45 caliber cartridges. Recommendations are made on the basis of these tests.

(3) Service tests. Service tests are intended to determine the suitability of hardware for use by the military under field conditions. They compare the hardware with requirements set down in the documents for the device being tested. The tests are always carried out on the complete device under field conditions. Acceptance tests are one form of service test.

(4) Surveillance tests. Surveillance tests are made on specific lots of ammunition taken from storage to determine if changes are needed in components to provide satisfactory operation as well as to determine the degree of deterioration of the original lot. Such tests should include adequate sampling of the lot to assure true representation and isolation of troublesome components, and adequate tests to assure satisfactory performance of renovated ammunition. Tests of this type will salvage lots of satisfactory ammunition whenever possible.

(5) Malfunction tests. Malfunction tests are carried out whenever failures have occurred. The rationale and planning for such tests is usually the responsibility of the investigator. Special tests are applied to pinpoint the cause of failure and recommend corrective action.

(6) NATO tests. NATO tests are prescribed for safety and environmental survival of all ammunition components planned for use by NATO countries. Engineering design tests are listed for airborne devices for both packaged and unpackaged stores.

b. *Light.*

(1) General. Light producers can be tested by use of human observers, simple electrical light detectors, or complex arrays of light detectors coupled to recording instruments and to computers for analysis of light intensity and spectral content as a function of time. Observers are used in many field situations that are difficult to assess by instrumentation systems and, therefore, play an important role in the ultimate testing of pyrotechnic light producers. Many test programs, for quality assurance of existing candles and the development of new types, are performed indoors at large military installations which have flare tunnels. A few instrumented outdoor sites are available to evaluate the light output of complete pyrotechnic ammunition under a semblance of field conditions.

(2) Laboratory tests. The candle of a pyrotechnic device is usually tested as a separate component in development, production, and quality control efforts. Candles with outputs of up to 106 candelas are commonly tested in areas equipped to contain the burning candle safely and to measure the emitted light under controlled conditions. These areas consist of a fireplace or hearth and a light tunnel. These facilities are well suited for making comparative measurements of burning time and candlepower of flares, but caution is required in relating values obtained to those obtained in different tunnels, outdoor facilities, and actual end item conditions. Large variations can easily occur depending on the test system, test procedures, and the inherent variability of the flares. If the candle is tested with the burning surface upward, for instance, the reading will be greater than if the burning surface is pointed downward. This is due to the differences in flame shape and smoke pattern. The practical difficulties in measuring true candlepower of pyrotechnic flames makes reference to the specification under which the test was performed necessary when quoting the candela for a particular device. Nevertheless, measurements made under comparable conditions are valuable to rate light output and to maintain quality standards. The light output of small arms tracer projectiles is measured in a spinner that is capable of rotating the projectile at up to 130,000 rpm's. Light intensity measurements in tunnels are affected by the following variables.

(a) Usually, large volumes of smoke issue from the test flare. The smoke can reflect light or obscure the flame depending upon the motion of the smoke. Blowers and dampers are used to adjust the wind velocity to maintain control of this variable.

(b) Power density radiated by the flare is a variable. The flare is not truly an isentropic source, as assumed in calculations, because flux is not radiated uniformly over the entire burning surface. Radiation from the cylindrical sides may be twice that from end on. Measurements in tunnels are usually made from the side of the flare.

(c) The area of the flare in the field of the photocell is a variable. Intensity readings will be incorrect if the field of the optical system includes only a portion of the flame produced by the flare. The entire flame produced by the flare should be in the field of view of the photocell, and any light reflected from the smoke in the vicinity of the burning flare should be kept to a minimum.

(d) The reflectivity of the background is a variable. Background reflections can produce particularly large errors in measurements of light output. Apparent increases of 40 percent have occurred because of reflections from the tunnel floor. This condition is corrected by restricting the view of the measuring instrument to that portion of the flare producing the light.

(e) The accuracy of the spectral correlation and intensity calibration is a variable. Spectral correction conforming to the response of the International Commission of Illumination and intensity calibration with standard sources for the test equipment are required.

(3) Field tests. The flame size and volume of smoke produced by some flares is too great for indoor tests. Such flares are tested outdoors at test sites that are relatively flat, open areas approximately 120 meters (400 feet) in diameter and that have a means of suspending the flare at least 24 meters (80 feet) above the center of a plane containing the photocells. Often the most practical method of evaluating light effects is visual observation supplemented with photography. This is particularly true of small arms tracers.

(4) Color measurement. The color of light producing illuminants is assessed by visual observation of flare burning or by the use of instruments that can dissect the light into characteristic colors or wavelengths. Quantitative spectral data allows the engineer to observe dilution of a desired color by unwanted colors, thus enabling corrections to be made. These procedures may also be used for quality control during production. A flare radiometer consists of a number (10 is used in the Picatinny Arsenal apparatus)

of interface filters, which cover the visible spectral region. The filters are chosen to have a uniform spectral response at a precisely chosen peak wavelength. Photocells and associated circuits are positioned behind the filters. The output of the photocells can be digitized and interfaced directly with a computer. Correction for human eye response can be made automatically. Candlepower can be computed by integration of the luminous intensity over the wavelength range of interest. Dominant wavelength and purity are determined by multiplying the radiant energy distribution by the three color distributions of the International Commission of Illumination, wavelength by wavelength. Chromaticity coordinates are calculated from the integrals under the three product curves and plotted in a chromaticity diagram to determine dominant wavelength and purity.

c. *Smoke.*

(1) General. In early stages of development, when gross effects are sought, much is gained by simple visual observation of the smoke produced. Visual observation is usually followed by still and motion photography to make better estimates of volume and color. In the case of screening smokes, quantitative measurements of the obscuring power can be made by the attenuation of light by the smoke. Signalling smokes have four properties of importance to the military: color, visibility, duration, and volume. Since instability is one of the main features of the smoke cloud, the ability to persist is usually judged by comparison with smoke from a control that is being burned simultaneously within close proximity of the test smoke generator. Care must be taken to observe that the two independent plumes are observed under similar atmospheric conditions.

(2) Laboratory tests. The test volume of the equipment used to measure smoke production may vary from a few cubic feet to several thousand cubic feet. The test chambers usually provide a means of physically manipulating the sample under test including parts or fittings for air, smoke, and exhaust; and an optical system for obscuration measurements. The screening values of smokes are determined by a figure of merit known as the total obscuring power (*TOP*) which is the area in square feet that can be obscured by a pound of smoke formulation. *TOP* can be measured directly by positioning a target in a smoke chamber until the target is just obscured. *TOP* can also be determined by measuring the attenuation of a light beam through a fixed distance of smoke. The intensity of the light as a function of incident intensity is given by the equation:

$$I=I_0 \exp(-eCL) \quad (10-1)$$

where I is the observed light intensity, I_0 is the intensity with no smoke present, C is the concentration of the smoke in pounds per cubic foot, L is the path length in feet, and e is the scattering or extinction coefficient in feet squared per pound. TOP is defined by the equation:

$$TOP = \frac{I}{C_i L_i}$$

where C_i is the concentration of smoke required for obscuration in pounds per cubic feet and L_i is the fixed distance between the lamp and photocell in feet. The concentration of smoke, C , from equation 10-1 is related to the concentration in equation 10-2 by the relationship:

$$C = Y C_i \quad (10-3)$$

where Y is the yield or the ratio of the weight of aerosol produced to the unit weight of the smoke producing composition. Combining equations 10-1, 10-2, and 10-3 yields:

$$TOP = \frac{Y}{\ln(I/I_0)} \quad (10-4)$$

where I_i is the transmitted light intensity under obscuration. The value of 0.0125 has been adopted by some researchers for the ratio I_i/I_0 based on physiological studies of the discriminating capacity of human vision. Equation 10-4 yields:

$$TOP = \frac{\ln(I_0)}{(\ln 0.0125) C L_i} \quad (10-5)$$

For fixed chambers and weights of smoke producing compounds equation 10-5 becomes:

$$TOP = K \log(I_i/I_0) \quad (10-6)$$

Equation 10-6 is valid if the smoke is dilute so that particle coalescence is minimal.

(3) Field tests. In the field, observers are often used in the assessment of smoke producing ammunition. A number of observers are commonly used in order to obtain statistically significant results. Any person with serious visual defects is eliminated, usually by tests made immediately before the observation. Color blindness is of particular concern when testing colored smokes. Observers are sometimes supplied with binoculars during smoke tests. They compare performance with controls having well known characteristics.

Wind tends to produce both good and bad effects in smoke production and use. In outdoor tests, wind speed and direction are normally recorded. Wind may aid in distributing the smoke for screening purposes. If the smoke is produced continuously, wind often helps to pinpoint a marked area by observing the origin of the plume. On the other hand, the wind may scatter the smoke. In testing field ready smoke producers, each sample is numbered. The ignition time and burning time of each sample is recorded. Comments concerning out of the ordinary conditions, such as excessive sparking on ignition, flame-ups while burning, and fuze failures are also recorded.

(4) Photographic techniques. Smoke plumes can be studied with time exposure photography. Exposure times of several minutes can be used to study the diffusion of smoke into the atmosphere. Time exposure during the daylight requires either an extremely slow film, a very small aperture, or the use of very dense filters. If these conditions cannot be attained, the dispersion photographs can be made under twilight conditions.

d. *Heat.* Incendiary devices are normally evaluated in terms of their ability to inflict specific damage against specifically defined targets such as burning a hole through a metal plate. The burning time is another of the parameters that is commonly measured. Several techniques, such as photography and the use of spectrometers and radiometers, have been tried to improve these testing methods. Photography with infrared film with appropriate filters can provide an effective means of evaluating the temperature distribution over the surface of a large flame, provided the fuel is relatively homogeneous and the observation path is relatively homogeneous. The film should be calibrated with a black body source of infrared and the calibration film and recording film should be processed identically. Small arms incendiary rounds can be evaluated by firing against an aluminum plate and recording the flash photographically. The photographs are compared to photographs of acceptable rounds. The following factors should be measured or assessed qualitatively in tests of flame producers. Quantitative methods have not been devised to measure all the factors:

- (1) Fuel dissemination in terms of "blob" size, spectral and spacial distribution.
- (2) Percentage of the fuel that ignited.
- (3) The adhesiveness of fuel "blobs" to different surfaces as a function of the type of surface, "blob" velocity, and altitude.

- (4) Fuel spread and runoff during burning.
- (5) Oxygen depletion or contamination.
- (6) Heating of the air in the vicinity of the target.
- (7) Damage capability as a function of target type.

e. *Gas-Operated Devices.* Pyrotechnic gas generators may be designed to produce various quantities of gas at various rates and temperatures and under a variety of loading conditions. Gas operated devices are tested under conditions nearly the same as those anticipated during use. Special test fixtures may be required, but normally a closed bomb with a fixed volume approximately equal to the volume in the actual application will suffice. Some test fixtures provide for expansion of the chamber with a moveable member as pressure is applied from the pyrotechnic device. This type of test measures the ability of the pyrotechnic device to do some minimum amount of work. Both the pressure and the displacement of the moveable member are measured. Piezoelectric sensors are used for pressure measurement. Capacitance, inductance, or resistance sensors are used for displacement measurement. Piston, bellows, and diaphragm motors can be actuated by the expanding gases. These motors are evaluated using force measuring transducers or by working them against springs. Testing includes measuring the time from the initiation impulse and the time from the start to the end of motion. The gas producer and the pressure bomb must be properly sealed. Copper washers are normally used for this purpose.

10-4. Analysis of Pyrotechnic Compositions. The following methods are used at the discretion of the researcher to yield the particular data sought.

a. *Differential Thermal Analysis.* The same method used in the analysis of explosives and discussed in Chapter 5 is used for pyrotechnic compositions. DTA can give qualitative information about the composition of a mixture. The presence of an endotherm or exotherm, which is characteristic to a particular compound, indicates the presence of the compound in the mixture. The ignition temperature of the mixture can be determined. DTA can also be used to determine the purity of the sample since impurities greatly affect the melting point. A sharp endotherm at the melting point indicates higher purity than a broad endotherm at a level slightly lower than the melting point.

b. *Thermogravimetry.* The same method used in the analysis of explosives and discussed in Chapter 5 is used for pyrotechnic compositions. Either method may be used on pyrotechnic compositions: the weight can be monitored as the temperature is programmed to rise linearly with time or the weight can be monitored at a constant temperature. The former is the preferred method.

c. *Infrared Spectroscopy.* This method is discussed in Chapter 13.

d. *Thermal Conductimetric Analysis.* In thermal conductimetric analysis, the electrical conductance of the material under test is measured as a function of temperature. The variation in conductivity is caused by such events as crystalline transitions which change the crystal lattice in such a way that the energy required to cause electrons to go from the bound state into the conduction band is altered.

e. *Electrothermal Analysis.* Electrothermal analysis consists of measuring two quantities as a function of temperature. The capacitance of the sample, which changes during a crystalline transition between two stable forms, is measured. The dissipation factor is also measured. The dissipation factor is the heat loss from an AC signal applied to the crystal. A transition also causes the dissipation loss to increase during the change between the two stable states.

f. *Classical Chemical Analysis.*

(1) To test for positive ions, add 300 milligrams of the sample to be tested to water and mix. Filter the slurry and divide the filtered solution into two parts. To one part of the solution add a drop of a saturated sodium sulfate solution. Barium or strontium will come out of the solution as a white precipitate. A flame test on a platinum wire, using the part of the solution that was not treated with sodium sulfate, identifies barium or strontium. A green flame is produced by barium salts and a red flame is produced by strontium salts. To find the quantities of barium and strontium, add sodium sulfate until no more precipitation is formed. Filter and weigh the precipitate. The untreated aqueous solution may be flame tested for sodium and potassium. A yellow and violet flame is produced respectively, although the potassium test is difficult. NH_4 can be detected by an ammonia smell after the solution has been made basic with sodium hydroxide.

(2) To test for anions, the barium and strontium ions must be removed by precipitation with an excess of sodium sulfate.

(a) To test for ClO_3 , add one milliliter of the test solution to one milliliter of a solution that was prepared from 20 grams of aniline hydrochloride and 50 milliliters of hydrochloric acid. The presence of the ion is indicated by a pink violet or dark blue color.

(b) To test for NO_3 , add two milliliters of the test solution to two milliliters of a solution that was prepared from 25 grams of FeSO_4 in 100 milliliters of distilled water and 25 milliliters of concentrated sulfuric acid. Hold the test tube at a slight angle and add one milliliter of concentrated sulfuric acid to the wall of the test tube. Manipulate the test tube to cause the drop to slide down the wall and into the solution. The drop of sulfuric acid will sink to the bottom. A brown color at the interface between the sulfuric acid and water indicates the presence of the nitrate.

(c) To test for ClO_4 , first prepare a solution of 40 milliliters of 10 percent aqueous CuSO_4 , 19 milliliters pyridine, and 50 milliliters of distilled water. This solution must be stored in a tightly stoppered bottle to avoid breathing the pyridine vapors. Add two milliliters of this solution to 3 milliliters of the solution under test. A precipitate of blue or white crystals indicates the presence of the perchlorate ion. If no precipitation forms in a few minutes, scratch the bottom of the test tube with a glass rod to try to induce crystallization.

(d) To determine the amount of the chlorate quantitatively, add an excess of NaHSO_3 , and then precipitate AgCl by adding an excess of silver nitrate solution. Filter and weigh the precipitate. One gram of precipitate corresponds to 0.855 grams of KC1O_2 in the mixture.

(e) To determine the amount of the perchlorate quantitatively, use tetraphenylphosphonium chloride to precipitate the tetraphenylphosphonium salt.

(f) To determine the amount of NO_3 , the chlorate and perchlorate must be removed from the solution. Then nitron is used to form a precipitate. Nitron is a standard reagent with the formula $\text{C}_{20}\text{H}_{16}\text{N}_4$ and a molecular weight of 312.38.

(3) In the original test mixture the materials which did not dissolve in water are most likely either metals, sulfur, or charcoal. Magnesium will cause the evolution of bubbles of hydrogen gas if five percent acetic acid is added. Aluminum will not. Aluminum will

evolve hydrogen in five percent hydrochloric acid or five percent sodium hydroxide. To test for iron, dissolve in dilute hydrochloric acid or nitric acid and add potassium ferrocyanide. A blue color indicates iron. To test for sulfur, dissolve in carbon disulfide or pyridine and dry the solvent. The characteristic yellow color indicates sulfur. Charcoal will produce an orange flame in the flame test.

10-5. Sensitivity.

a. *Impact.* This test is performed on any of the various impact sensitivity devices.

b. *Friction.* This test is performed on the pendulum friction device.

c. *Hygroscopicity.* In this test a weighed sample of the material is subjected to air at a specified temperature and relative humidity. The weight gain is noted.

d. *Sensitivity to Heat.* Three methods are used to measure sensitivity to heat.

(1) In the first method, a sample of the material is contained in a blasting cap and immersed in molten metal bath. The temperature of the bath is controlled so that a reaction occurs in five seconds.

(2) In the second method, isothermal heating, a sample of the material is subjected to a preselected temperature for an extended period. This method determines the induction period of the material at a specified temperature.

(3) In the third method, adiabatic heating, a sample is placed in an oven or furnace and heated at a slow rate. A thermocouple monitors the temperature at the sample. When an exothermic reaction starts, the temperature of the furnace is adjusted so no heat is gained or lost by the sample. The temperature at which the reaction accelerates to deflagration is called the autoignition or deflagration temperature.

e. *Electrostatic Discharge.* The standard electrostatic discharge sensitivity device described in Chapter 5 is used for this test.

f. *Compatibility.* This test is performed by mixing a sample of the pyrotechnic composite with another material and subjecting the mixture to the 120°C vacuum stability test for 40 hours.

10-13/(10-14 blank)

CHAPTER 11 FOREIGN ENERGETIC MATERIALS

11-1. Introduction. This chapter reflects the currently available, unclassified information on foreign energetic materials. Security restrictions may, in some cases, date the material presented. Generally, foreign energetic materials are the same as those used by the United States although the composition of some of the composites varies.

11-2. French Energetic Materials. No information is presented on priming compositions or initiating explosives. The French for fulminating explosives such as mercury fulminate is *explosifs fulminants*. Table 11-1 lists some of the secondary explosives used by the French.

Table 11-1. French Secondary Explosives

English	French
TNT	Trotyl
Pyroxylin	Pyroxyline, collodion
Pyrocellulose	Coton-Poudre (CP)
Guncotton	Coton-Poudre (CP)
Nitroglycerin	Nitroglycerine
Nitrostarch	Nitrate d' amidon
PETN	Penthrite
TEGN	Dinitrate de triethyleneglycol
HMX	Octogene, cyclotetramethylenetetramin
RDX	Hexogene, T4, cyclotrimethylene-trinitramine
Picric acid	Melinite

The following explosives are also used by the French:

a. *Explosif Amylace.* These are the amide explosives. An inorganic amide explosive, also called ammonobase, is a compound in which one hydrogen is replaced by a metal. Metallic amides are prepared by precipitation from liquid ammonia solutions by the action of potassium amide, KNH_2 . Potassium amide is also referred to as potassamide. An organic amide contains

the monovalent radical $-\text{CO.NH}_2$. Organic amides are nonexplosive unless nitrated and are not considered here. The metallic amides include:

(1) Auric imidoamide, $\text{Au} (: \text{NH}) \text{NH}_2$ or HN:Au.NH_2 , is an extremely explosive and sensitive powder. The compound does not explode when wet and so is stored under water. Storage at 100°C for several hours causes auric imidoamide to become so sensitive that handling without an explosion is virtually impossible.

(2) Cadmium amide, $\text{Cd}(\text{NH}_3)$, is a white powder which explodes upon rapid heating. The salt can be prepared by treating cadmium iodide or KCd cyanide with a solution of potassamide in liquid ammonia. When heated to 180°C in vacuo, cadmium amide loses ammonia leaving cadmium nitride, Cd_3N_2 , a black, amorphous powder that explodes when brought in contact with water.

(3) Potassium amide, KNH_2 , is not used as an explosive but is used as an intermediate in the preparation of other explosive amides. The normal method of preparation is to add a small amount of platinum black to a solution of liquid ammonia and metallic potassium. Without the platinum, the reaction takes weeks or months.

(4) Silver amide, AgNH_2 , is a white precipitate which darkens and shrinks in volume on exposure to air. The compound can be prepared by mixing a solution of potassamide with silver nitrate or iodide in liquid NH_3 followed by washing by decantation and careful drying. This compound is extremely sensitive and can shatter test tubes and tear holes in several layers of towels wrapped around the tube for the protection of the operator.

(5) Sodium amide, NaNH_2 , consists of white crystals with a melting point of 206.4°C . The compound dissolves in liquid NH_3 and is vigorously hydrolyzed by water. Preparation is by means of metallic sodium dissolved in ammonia, the reaction is catalyzed by iron wire.

b. *Explosifs Antigrisouteux.* These are French industrial explosives used in coal mines. Under prescribed conditions these do not ignite mixtures of methane, air, and coal dust. Some standard compositions are:

Components	N no 7	N no 9	N no 62
Ammonium nitrate (%)	76.0	48.2	12.0
Dinitronaphthalene (%)	7.0	-	-
TNT (%)	-	9.15	-
PETN (%)	-	-	23.0
Wood flour (%)	2.0	1.65	-
Sodium chloride (%)	15.0	41.0	65.0

c. *Explosifs Chlorates*. These explosives are also known as chlorate cheddites or chlorate streetites. The chlorate cheddites may be subdivided into nongelatin and gelatin types. The nongelatin type cheddites are in the form of soft grains which are white or yellow in color unless they have been artificially colored with an oil soluble dye in order to distinguish one type from another. They are readily compressible and, in order to obtain the full explosive power, their density should be carefully controlled. If the density is low, the maximum power is not developed but if the density is very high detonation is difficult. These explosives are relatively insensitive to shock and friction at room temperature and, when unconfined, burn more or less rapidly without any tendency to explode even when fired in large masses. Heating at 120°C for an appreciable period causes no decomposition. But at 200°C the oil in cheddite decomposes, part of the nitrocompound volatilizes, and the whole mass darkens. Heating of cheddites in small quantities to 250° to 265°C causes deflagration. Densities of compressed materials average 1.3 to 1.4, power (by Trauzl test) is slightly less

than that of TNT, but brisance is only 30 to 50 percent of TNT due to the low detonation velocity, 2,300 to 3,200 meters per second. The rate of detonation depends not only on composition but also on density. The rate of detonation increases as the density increases up to a certain optimum density, but then the rate decreases very rapidly. For example, one of the cheddites developed the rate 2,283 meters per second at a density of 1.07 grams per cubic centimeter which increased to 2,901 meters per second at a density of 1.17 grams per cubic centimeter but dropped to 2,451 meters per second at a density of 1.14 grams per cubic centimeter and failed to detonate at density of 1.5 grams per cubic centimeter. None of the chlorate cheddites can contain any ammonium salt because double decomposition might take place with the formation of dangerous ammonium chloride. Cheddites containing potassium or sodium perchlorates are more stable and less reactive than those containing potassium or sodium chlorate. Ammonium perchlorate may also be used, provided chlorates are absent. Sodium chlorate is more hygroscopic than potassium chlorate, but is more economical and contains more oxygen per unit weight. The gelatin type cheddites are plastic type explosives which do not harden in storage. These explosives are not very powerful but their brisance is superior to any ammonium nitrate explosive. Tables 11-2 and 11-3 give the composition of some of the most current French cheddites.

Table 11-2. French Chlorate Cheddites

Composition and some properties	55 -CSE -1948	58 -CSE -1948	gelatin cheddite n° 18
Sodium chlorate (%)	74	74	74.0
DNT (liquid) (%)	23	23	19.0
Sawdust (%)	-	3	-
Cork flour (%)	3	-	-
NG (%)	-	-	5.5
Collodion cotton (%)	-	-	1.5
Density, grams per centimeter	-	-	2.0
Power (picric acid 100%)	93	89	83

Table 11-3. French Perchlorate Cheddites

Composition	I	II	III	Sevrانيتes	
				n°1	n°2
Ammonium perchlorate (%)	82	50	88 - 9	31	42
Sodium nitrate (%)	-	30	-	-	-
DNT (%)	13	15	-	-	-
Castor oil (%)	5	5	-	-	-
Paraffin (%)	-	-	12 - 10	-	-
Collodion cotton (%)	-	-	-	-	-
PETN (%)	-	-	-	48	42
Plasticizer (%)	-	-	-	18	16
Aluminum powder (%)	-	-	-	3	-

d. *Explosifs Couche*. These are explosives with temperatures of explosion of below 1,500°C which are permitted for use in coal layers of fiery coal mines. For example, Grisou naphthalite couche contains 95 percent ammonium nitrate and 5 percent trinitronaphthalene, while Grisou dynamite couche contains 12 percent nitroglycerin, 0.5 percent collodion cotton, and 87.5 percent ammonium nitrate. Sodium chloride is also used in couche to reduce the explosion temperature.

e. *Explosifs CSE*. These are a series of explosives developed at the laboratory of the Commission des Substances Explosives (CSE). The explosifs chlorates

are actually CSE explosives. Other examples include: 63-CSE-1949 which contains 67 percent ammonium nitrate, 12 percent 20/80 pentolite, and 21 percent aluminum powder; 68-CSE-1949 which contains 20 percent ammonium nitrate, 20 percent PETN, 1.5 percent dinitronaphthalene, and 58.5 percent sodium chloride; 123-CSE-1948 which contains 17 percent ammonium nitrate, 23 percent PETN, and 60 percent sodium chloride; and 133-CSE-1948 which contains 22 percent ammonium nitrate, 20 percent PETN, 3 percent TNT, and 55 percent sodium chloride. These are used in fiery coal mines. Table 11-4 shows some of the silicon CSE explosives.

Table 11-4. CSE Silicon Explosives

Composition and properties	Designation of explosive			
	n°78 CSE-1950	n°88 CSE-1950	Nn°O	Nn°31
Ammonium nitrate (%)	79.0	82.0	78.7	78.5
Silicon (pulverized) (%)	5.5	7.4	-	-
Aluminum (granular) (%)	-	-	-	9.2
TNT (%)	-	10.6	21.3	-
Pentolite (20/80) (%)	15.5	-	-	12.3
Density, grams per centimeter	1.40	1.24	1.40	1.40
Velocity of detonation meters/second	4,700	4,000	4,460	4,150

Some of the following plastic explosives were developed by the CSE. 33-CSE-1951 contains 75 percent RDX, 21 percent nitroglycerin, and 4 percent nitropolystyrene. 34-CSE-1951 contains 88 percent ammonium nitrate and 12 percent RDX. 36-CSE-1951 contains 82 percent RDX and a solution of 40 percent polystyrene in liquid DNT. This explosive has a velocity of detonation of 7,520 meters per second. 37-CSE-1951 contains 85 percent ammonium nitrate and 15 percent nitropolystyrene. 38-CSE-1951 contains 72.25 percent ammonium nitrate, 12.75 percent nitropolystyrene, and 15 percent sodium chloride.

f. *Explosif D*. This explosive contains 85 percent RDX and 15 percent TNT.

g. *Explosifs et Poudres*. These explosives and propellants include mixtures of combustibles such as nitroguanidine, hexanitrodiphenylamine (HNDPhA), and 9-oxo-2,4,5,7-tetranitrothiodiphenylamine with oxidizers such as nitrates, chlorates, or perchlorates. A mixture of 53 percent nitroguanidine and 47 percent ammonium perchlorate and a mixture of 56 percent nitroguanidine and 44 percent potassium nitrate possess high temperatures of deflagration and are suitable for use in weapons operating at high temperatures or for oil seismic prospecting at great depth.

h. *Explosifs Roche*. These explosives, with temperatures of explosion between 1,5000C and 1,9000C, are permitted for use in rock layers of fiery coal mines. Grisou dynamite roche contains 29 percent nitroglycerin, 1 percent collodion cotton, and 70 percent ammonium nitrate. Grisou dynamite roche salpêtre contains 29 percent nitroglycerin, 1 percent collodion cotton, 5 percent potassium nitrate and 65 percent ammonium nitrate.

11-3. German Energetic Materials. Table 11-5 lists some of the secondary explosives used by the Germans.

Table 11-5. German Secondary Explosives

English	German
DEGN	Diathylenglykol-dinitrat
Pyroxylin	Kollodiumwolle
Pyrocellulose	Schiessbaumwolle
Guncotton	Schiessbaumwolle, schiesswolle
Nitroglycerin	Nitroglyzerin
Nitrostarch	Nitrostaerke, staerkenitrat

Table 11-5. German Secondary Explosives (Cont)

English	German
PETN	Peutrit, niperyth, nitropenta (NP)
TEGN	Triglykoldinitrat
EDDN	Diamin
Nitroguanidine	Gudol
TNT	Fp 02

11-4. Italian Energetic Materials. Italian explosives are listed in table 11-6.

Table 11-6. Italian Explosives

English	Italian
Lead azide	Azotidrato di piombo, acido di piombo
Lead styphnate	Stifnato di piombo
Mercury fulminate	Fulminato-di mercurio
Tetracene	Guanilnitrosoammina, tetrazene
DEGN	Nitrodiglicole, nitroeterolo, dinitrodietilenglicol
Collodion cotton (11.2 to 12.3% N)	Cotone collodio
Pyrocellulose (12.5 to 12.7% N)	Pirocollodio
Guncotton (13.2 to 13.4% N)	Fulmicotoneo cotone fulminante
Nitroglycerin	Nitroglicerina
PETN	Pentrite, tetranitrato di penaeritrite
TMETN	Metriolo (nitrometriolo), nitropentaglicerina
HMX	Ciclotetrametilentetranitroammia, octogene, HMX
RDX	Ciclonite, ciclotrimetilentrinitroammia
Nitroguanidine	Nitroguanidina
Tetryl	Tetrile
Ammonium picrate	Picrato ammonico, picrato di ammonio
TNT	Tritolo

The following explosives are used by the Italians:

a. *Afocite*. Afocite is a blasting explosive composition in two formulations. One formulation is 58 percent to 62 percent ammonium nitrate, 28 percent to 31 percent potassium nitrate, 7 percent to 9 percent carbon, and 2 to 3 percent sulfur. The other formulation is 58 to 62 percent ammonium nitrate, 31 percent to 38 percent potassium nitrate, 3.5 percent to 4.5 percent charcoal, 2 percent to 3 percent sulfur, and 1.5 percent moisture.

b. *Amatolo*. These are the amatols. The most popular mixture is tipo 60/40, which has 60 percent ammonium nitrate and 40 percent TNT. Other compositions used are tipo 80/20 and tipo 90/10.

c. *Ammonaftite*. This is a mining explosive containing 76.7 percent ammonium nitrate, 15 percent nitroglycerin, 0.3 percent collodion cotton, 0.3 percent grain flour, and 0.5 percent yellow ochre.

d. *Ammonal*. These are mixtures containing various percentages of ammonium nitrate, aluminum, and TNT.

e. *Ammonite No. 1*. This is a blasting explosive consisting of 88 percent ammonium nitrate, 3 percent DNT, 3 percent nitroglycerin, 5 percent vegetable flour, and 1 percent diphenylamine.

f. *Antigrison*. These are permissible explosives. Autigrison N.O contains 80.57 percent ammonium nitrate, 6.36 percent dinitronaphthalene, and 13.02 percent ammonium chloride. Autigrison N.2 contains 81.49 percent ammonium nitrate, 11.11 percent dinitronaphthalene, and 7.4 percent ammonium chloride. Autigrison N.3 contains 82 percent ammonium nitrate, 5 percent trinitronaphthalene, and 13 percent ammonium chloride.

g. *Autonile*. There are two explosive mixtures of ammonium nitrate and TNT. In one, used in quarries, the oxygen content is 5.9 percent. The other, used in tunnels, has an oxygen content of 3.08 percent.

h. *BM*. These are a series of mining explosives.

(1) BM.1. per galleria is a grey powder consisting of TNT, ammonium nitrate, and thermite.

(2) BM.as. per uso a cielo aperto is a reddish powder consisting of ammonium nitrate, cyclic aliphatic compounds, and metallic powders.

(3) BM.ac. per uso a cielo aperto is a brownish yellow powder containing ammonium nitrate and TNT.

(4) BM.57. per uso a cielo aperto is a greyish black powder based on ammonium nitrate.

(5) Super BM. per galleria is a green powder which is slightly plastic. The powder contains aromatic nitrocompounds with organic nitrates and plasticizers.

(6) BM.a2 is a brown powder containing ammonium nitrate, TNT, and thermite.

(7) Super BM. cava is a grey powder.

(8) BM.2. per galleria is a grey powder containing an inorganic nitrate, organic nitrocompounds, and aluminum powder.

(9) Carlsoniti are perchlorate based explosives such as one formulation that contains 85 percent KClO_4 and 15 percent vaseline and another that contains 88 percent KClO_4 and 12 percent dinitrobenzene.

i. *Italian Dynamites*. Italian dynamites are divided into two groups, those with inert bases and those with active bases.

(1) The inert base dynamites are:

(a) Tipo I which consists of 70 to 75 percent nitroglycerin and 25 to 30 percent kieselguhr.

(b) Tipo II which consists of 50 percent nitroglycerin and kieselguhr.

(c) Dinamite nera (black dynamite) which consists of 45 to 55 percent nitroglycerin and 45 to 55 percent coke.

(d) Dinamite al carbonie di legno (charcoal dynamite) which consists of 90 percent nitroglycerin and 10 percent charcoal.

(e) Dinamite rossa (red dynamite) contains 68 percent nitroglycerin and 32 percent tripoli.

(f) Wetter-dinamite (permissible dynamite) contains 35 to 40 percent nitroglycerin, 10 to 14 percent kieselguhr, and 32 to 50 percent magnesium sulfate.

(2) The active base dynamites are:

(a) Gelatinagomma (or gelatina esplodente) which is a blasting gelatin with the composition of 92 to 93 percent nitroglycerin and 7 to 8 percent collodion cotton.

(b) Gelatina esplosiva da guerra which is a military blasting gelatin with the composition 86.4 percent nitroglycerin, 9.6 percent collodion cotton, and 4 percent camphor.

(c) Gelatina dinamite is a gelatin dynamite containing 67 to 86 percent nitroglycerin, 3 to 5.5 percent collodion cotton, 5 to 25 percent potassium nitrate, and 2 to 10 percent woodflour.

(d) Ammon dinamite (gelatina 65 percent) contains 63 percent nitroglycerin, 2 percent collodion cotton, 30 percent ammonium nitrate, and 5 percent woodflour.

(e) Gelatina dinamite incongelabile o antigelo, a nonfreezing gelatin dynamite, contains 20 to 25 percent nitroglycerin, 1 to 2 percent collodion cotton, 8 to 12 percent nitrotoluenes, 25 to 60 percent of a mixture that contains sodium nitrate and ammonium nitrate, and 1 to 8 percent cereal flour.

(f) Gelatina 40 percent contains 40 percent nitroglycerin, 10 percent drip oil, 44 percent sodium nitrate, and 6 percent cereal flour. The drip oil contains liquid DNT's and is a biproduct of TNT manufacture.

(g) Ammon-gelatina I contains 40 percent nitroglycerin which has been gelatinized with collodion cotton, 45 percent ammonium nitrate, 5 percent sodium nitrate, and 10 percent woodflour.

(h) Ammon-gelatina II contains 20 percent nitroglycerin gelatinized with collodion cotton, 75 percent ammonium nitrate, and 5 percent woodflour.

(i) Dynamite No. 1, non-gelatinizzate contains 70 to 74 percent nitroglycerin and 30 to 26 percent woodflour.

(j) Dynamite No. 2, non-gelatinizzate contains 35 to 48 percent sodium nitrate and/or lead nitrate (52 to 39 percent) with 12 to 17 percent cereal flour.

(k) Table 11-7 lists the composition of some more nitroglycerin based dynamites. GDI, GDII, CD2, GDM, GEO, gomma A, and gomma B are the most frequently used.

j. *Diamon*. This is an explosive which consists of 69 percent ammonium nitrate, 8 percent KC104, 20 percent TNT, and 3 percent aluminum.

k. *Diamon 1B*. This is a mining explosive containing ammonium nitrate, TNT, woodmeal, 3 to 6 percent nitroglycerin, and some other ingredients.

l. *Esplosivi Da Mina*. Mining explosives are listed in tables 11-8 and 11-9.

**Table 11-7. Esplosivi Da Mina Gelatinosi Con Nitroglicerina
(Mining Explosives with Nitroglycerin)**

Composition (%) and some properties	1 GDII	2 GD2	3	4 GDI	5 GDIM	6 GEOM	7	8	9 GEO	Gomma		GDM
										B	A	
Nitroglycerin	43.2	48.3	7.0	60.0	38.0	57.0	71.0	40.75	77.5	82.5	92	38.0
Collodion cotton	2.3	2.7	0.8	3.5	2.3	3.5	5.0	1.5	5.0	5.5	8	2.3
Ammonium nitrate	-	-	-	-	50.9	29.0	-	17.0	-	-	-	50.4
Ammonium perchlorate	-	-	44.0	-	-	-	-	-	-	-	-	-
Woodflour	7.0	5.8	1.0	5.2	-	3.5	5.0	-	5.0	3.0	-	-
Dinitrotoluene	-	-	10.0	-	-	-	-	-	-	-	-	-
Trinitrotoluene	-	-	5.0	-	-	-	-	-	-	-	-	-
Sodium nitrate	45.5	42.7	32.2	30.5	6.0	7.0	-	-	12.0	8.5	-	6.0
Potassium nitrate	-	-	-	-	-	-	18.5	-	-	-	-	-
Calcium silicide	-	-	-	-	-	-	-	-	-	-	-	-
Oil	-	-	-	-	2.0	-	-	-	-	-	-	2.5
PETN	-	-	-	-	-	-	-	40.75	-	-	-	-
Ocher, red (hematite)	-	-	-	0.3	0.5	-	0.5	-	-	-	-	0.5
Ocher, yellow (limonite)	1.0	-	-	-	-	-	-	-	-	-	-	-
Sodium carbonate	1.0	0.5	-	0.5	-	-	-	-	0.5	0.5	-	-
Calcium carbonate	-	-	-	-	0.3	-	added 0.3	-	-	-	-	0.3
Trauzl test, cc	340	355	430	440	475	500	505	525	540	560	630	475
Gap test, cm	14	15	6	20	21	23	26	25	29	30	35	-
Velocity of detonation, m/sec	5,000	5,200	4,700	6,000	5,900	5,400	5,900	7,000	6,700	6,900	7,200	-

**Table 11-8. Esplosivi Da Mina Polverulenti Con Nitroglicerina
(Pulverulent Mining Explosives with Nitroglycerin)**

Composition (%) and some properties	1	2	3	4	5	6	7	8	9	10	11	12
Nitroglycerin	14.0	11.0	10.0	4.0	4.0	8.0	12.4	12.76	4.0	12.0	11.7	9.0
Dinitrotoluene	-	-	-	1.5	-	0.5	0.3	-	-	-	-	-
Trinitrotoluene	-	-	-	-	-	-	-	-	10.0	0.3	-	20.0
Collodion cotton	0.3	-	0.25	1.5	0.1	0.5	0.3	0.24	-	-	0.3	0.3
Woodflour	-	6.0	-	-	-	-	-	-	-	-	-	-
Cereal flour	-	-	-	-	-	5.0	-	-	-	3.0	-	-
Ammonium picrate	65.7	51.0	89.75	82.0	89.4	81.0	79.0	83.0	76.0	77.7	76.0	70.7
Sodium nitrate	-	-	-	-	-	-	-	-	-	-	-	-
Potassium nitrate	-	-	-	-	-	-	-	-	-	-	-	-
Dinitronaphthalene	-	10.0	-	-	-	-	8.0	4.0	10.0	-	10.0	-
Potassium perchlorate	-	-	-	-	-	-	-	-	-	-	-	-
Sodium chloride	20.0	22.0	-	11.0	-	-	-	-	-	-	-	-
T4 (RDX)	-	-	-	-	6.5	-	-	-	-	-	-	-
Oil	-	-	-	-	-	-	-	-	-	2.0	2.0	-
Calcium silicide	-	-	-	-	-	5.0	-	-	-	5.0	-	-
Trauzl test, cc	270	265	300	305	320	375	390	390	400	420	430	450
Gap test, cm	2	5	20	3	12	6	3	4	11	1	1	6
Velocity of detonation, m/sec	2,120	2,300	2,038	1,710	2,500	3,200	2,715	3,200	2,348	2,960	2,350	2,912

**Table 11-9. Esplosivi Da Mina Polverulenti Senza Nitroglicerina
(Pulverulent Mining Explosives Without Nitroglycerin)**

Composition (%) and some properties	1	2	3	4	5	6	7	8	9	10	11	12	13	14
Ammonium nitrate	85.5	77.0	40.0	78.0	82.0	80.0	79.5	70.0	84.5	90.0	-	79.0	70.0	63.0
Dinitronaphthalene	-	-	-	-	-	-	-	5.0	10.0	-	-	-	-	-
Dinitrotoluene	-	-	-	-	1.0	-	-	-	-	-	-	-	-	-
Trinitrotoluene	4.5	15.0	-	16.0	14.0	20.0	10.0	10.0	-	8.0	90.0	-	-	-
Ammonium perchlorate	-	-	25.0	-	-	-	-	-	-	-	-	-	-	-
Potassium perchlorate	-	-	-	-	-	-	-	-	-	-	-	-	-	-
Potassium nitrate	-	-	29.0	-	-	-	-	-	-	-	-	-	-	-
Woodflour	10.0	6.5	4.0	-	3.0	-	2.5	-	-	2.0	-	1.0	-	3.0
Oil	-	-	2.0	-	-	-	-	-	-	-	-	-	-	-
Paraffin	-	-	-	-	-	-	-	-	-	-	-	-	-	-
Sodium nitrate	-	-	-	4.5	-	-	8.0	15.0	-	-	-	-	-	13.0
Potassium bichromate	-	-	-	-	-	-	-	-	4.5	-	-	-	-	-
Carbon (pulverized)	-	1.5	-	-	-	-	-	-	1.0	-	-	-	-	-
Charcoal (pulverized)	-	-	-	-	-	-	-	-	-	-	-	-	-	-
PETN or RDX	-	-	-	-	-	-	-	-	-	-	10.0	20.0	30.0	21.0
Calcium carbonate	-	-	-	1.0	-	-	-	-	-	-	-	-	-	-
Ocher (hematite)	-	-	-	0.5	-	-	-	-	-	-	-	-	-	-
Trauzl test, cc	330	330	350	400	420	430	450	360	395	375	400	425	450	480
Gap test, cm	1	2	3	6	6	7	7	2	3	1	4	5	3	6
Velocity of detonation, m/sec	1,900	2,300	2,400	3,600	3,700	4,300	3,500	1,600	3,100	2,300	7,000	2,850	2,100	3,000

m. *Esplosivi di Primari*. These are primary explosives. Mercury fulminate has been replaced by lead azide and lead styphnate.

n. *Esplosivi di Rinforzo*. These are the booster explosives. RDX, PETN, and tetryl are used.

o. *Esplosivi di Scoppio*. These are the high explosives. Those which have been used include amatolo, ammonal, HMX, PETN, pentolite, RDX, tetryl, TNT, tritolital (60 percent TNT, 20 percent RDX, and 20 percent aluminum), and tritolite (60 percent RDX, 39 percent TNT, 1 percent beeswax). The following bursting explosives have been patented in Italy for military use. One is a cast explosive that is prepared by incorporating 75 percent RDX or PETN with 25 percent nitroisobutylglycerol. Another explosive consists of 5 to 65 percent RDX or PETN with 30 to 90 percent TNT, and 5 to 30 percent powdered metals such as silicon, boron, magnesium, copper, iron, aluminum, or zinc. RDX and 8 to 14 percent castor oil pressed in the form of beads has also been patented. A process for directly producing a cast explosive has also been patented. Molds or bomb bodies are loaded with a granulated mixture of nitrocellulose and a high explosive followed by the addition of a solvent containing a nitrated ester, a stabilizer, a plasticizer, and sometimes an accelerating agent. The final composition of the explosive may be 5 to 36 percent nitrocellulose, 33 to 40 percent nitrate ester, 20 to 60 percent high explosive, 1.5 to 2.5 percent plasticizer, 0.5 to 0.6 percent stabilizer, and 0.4 to 0.5 percent accelerating agent. The granulated composition is obtained by mixing the nitrocellulose, the high explosive, a plasticizer (diethylphthalate), and a stabilizer (centralite) with a nitrocellulose solvent (acetone). The paste obtained is impregnated in the mold with nitroglycerin and the diethylphthalate in a solvent, centrifuged, and gelled at 50°C. Another explosive consists of RDX or PETN with high density nitrates such as lead nitrate, barium nitrate, and zinc stearate.

p. *Esplosivo Plastico*. This is a plastic explosive suitable for military use which consists of 85 to 89 percent RDX, 10 to 12 percent petrolatum, 0.5 to 2 percent plastic binder, and 0.5 to 1 percent glycerophthalic acid. An aluminized version consists of 64 to 75 percent RDX, 10 to 12 percent petrolatum, 10 to 25 percent aluminum powder, 0.5 to 2 percent plastic binder, and 0.5 to 1 percent glycerophthalic acid.

q. *Esplosivo S20*. This is a military explosive which contains 79 percent ammonium nitrate, 20 percent TNT, and 1 percent woodflour.

r. *Grisou Dinamite*. This is a permissible explosive containing 88 percent ammonium nitrate, 10 percent nitroglycerin, 0.5 percent collodion cotton, and 1.5 percent woodflour.

s. *Grisounite*. This explosive contains 95.5 percent ammonium nitrate and 4.5 percent trinitronaphthalene.

t. *Grisounite Gomma*. This explosive contains 70 percent ammonium nitrate, 29.5 percent nitroglycerin, and 0.5 percent collodion cotton.

u. *Grisounite Roccia* or Rock Grisounite. This explosive contains 91.5 percent ammonium nitrate and 8.5 percent trinitronaphthalene.

v. *Hexocire*. This is a mixture of RDX and beeswax.

w. *Hexocire-Aluminum*. This explosive is a mixture of 80 percent RDX, 5 percent beeswax, and 15 percent aluminum.

x. *Hexaliti*. These are mixtures of RDX and aluminum in various proportions.

y. *MAT*. This is the Italian name for picratol.

z. *Miscela C or PE*. A plastic explosive consisting of RDX and a plasticizer. Miscela C₂, which is waterproof, consists of RDX, collodion cotton, and a plasticizer. Miscela C₃ consists of RDX, tetryl, collodion cotton, and a plasticizer. Miscela C₄ consists of 91 percent RDX with polyisobutylene and other ingredients.

aa. *NA OC*. This is the Italian name for ANFO explosives.

bb. *Nitroglicol*. This explosive is also called dinitroglicol in Italian. The English term is ethyleneglycol dinitrate. This compound is used in many countries as an antifreeze in nitroglycerin mixtures such as dynamite.

cc. *Nobelite Galleria*. This is a mining explosive consisting of 37 percent nitrocellulose, 34 percent KClO₄, 24 percent NaNO₃, 3 percent DNT, and 2 percent mineral oil. The temperature of explosion is 2,800°C. At about 130°C the explosive burns in air.

dd. *Nougat or MST*. This is an amatol type explosive used as a shell filler which consists of 49 percent ammonium nitrate, 44 percent TNT, and 7 percent dinitronaphthalene.

ee. *NTP*. This is a military explosive that consists of 77 percent ammonium nitrate, 20 percent RDX, and 3 percent paraffin.

ff. *Oxiliquite*. This is one of the liquid air explosives prepared in situ by pouring liquid air or liquid oxygen into a mixture of three parts carbon impregnated with two parts petroleum.

gg. *Oxilite*. This is another liquid air or oxygen explosive prepared in situ. The fuel in this explosive is fossil flour that has been impregnated with petroleum.

hh. *Pentritolo*. In Italian this is also called pentrol. The English name is pentolite.

ii. *PNP Esplosivo*. This is an explosive used for press loaded projectiles that consists of 20 percent PETN, 77 percent ammonium nitrate, and 3 percent wax.

jj. *Polvere FB*. There are 860 and 960 calorie types which contain 32 and 31 percent nitroglycerin, 57 and 61 percent nitrocellulose (12 percent nitrogen content), 9 and 5.5 percent butylphthalate, and 2 and 2.5 percent centralite. Both are used in rapid fire cannons.

kk. *Polvere FC*. There are 860 and 960 calorie types which contain 28 and 32 percent nitroglycerin, 64 and 62.5 percent nitrocellulose (12 percent nitrogen content), 4 and 3.5 percent centralite, and 1 and 0.5 percent vaseline. Both are used in rapid fire cannons.

ll. *Polvere NAC*. There are 860 and 960 calorie types which contain 27 and 32 percent nitroglycerin, 66 and 63 percent nitroacetylcellulose (11.2 percent nitrogen content), 7 and 4 percent centralite, and 0 and 1 percent DPhA. Both are used as cannon propellants.

mm. *Polvere Nera*. Italian for black powder.

nn. *Polvere al Nitrodigical*. There are 860 and 730 calorie types which contain 68 and 27 percent DEGN, 30 and 63.5 percent nitroacetylcellulose, 0 and 5 percent acetylcellulose, and 2 and 4.5 percent centralite.

oo. *Polvere al Nitrometriolo*. These are propellants with TMETN. M4, M6, and M8 have compositions of 55.5, 57.5, and 59 percent TMETN; 40, 36, and 33 percent nitrocellulose; 2.5, 4.5, and 5.9 percent acetylmetriol; 2, 2, and 2.5 percent centralite.

pp. *Polveri da Lancio Senza Fumo*. These are the smokeless propellants. These are divided into single based propellants with a volatile solvent, double based propellants with nitroglycerin, double-base propellants without a volatile solvent, double-base propellants with a volatile solvent, and propellants with several components.

qq. *T₄ Plastico*. Two mixtures are known. One has 89 percent RDX and 11 percent vaseline and the other has 78.5 percent RDX, 17.5 percent DEGN (which contains 0.3 to 0.4 percent collodion cotton), and 3 percent vaseline.

rr. *Tetranitroauilina*. This is an explosive used in crystal form in some detonators.

ss. *Tetritol*. Italian for tetrytol.

tt. *Trinitrofloroglucinato di Piombo*. This compound is used in some initiating compositions in place of lead styphnate.

uu. *Umbrate*. There are two formulations of this explosive. Umbrate A contains 48.4 percent nitroguanidine, 37.3 percent ammonium nitrate, and 14.3 percent ferrosilicon. Umbrate B contains 45.1 percent nitroguanidine, 41.4 percent ammonium nitrate, and 13.5 percent ferrosilicon. Both are used as bursting charges in some projectiles.

11-5. Japanese Energetic Materials. Table 11-10 lists the Japanese explosives.

Table 11-10. Japanese Explosives

English	Japanese
Lead azide	Chikkgen, chikka namari
Mercury fulminate	Raiko, raisan
Nitrocellulose	Shokamen
Guncotton	Menyaku
Nitroglycerin	Nitoroguriserin
PETN	Shoeyaku
RDX	Shouyaku, tanayaku
Tetryl	Meiyaku, sanshoki, mechira nitroamin
Ammonium picrate	Picurinsan ammonia
TNT	Chakatsuyaku, sanshokitoruoru
Ammonium nitrate	Ammon shosanen

The following limited data is available on the most currently used Japanese energetic material. Japan has no army but has a national self defense force. Energetic material research is done for this organization. Current developments and usage are along the lines of that in the western countries.

a. *Akatsuki*. This is an ammonium nitrate explosive containing 73 to 75 percent ammonium nitrate, 5 to 6 percent nitroglycerin gel, 3 to 5 percent cellulose, and 9 to 14 percent other ingredients. The explosive has a detonation velocity of 3,490 meters per second, an empirically determined detonation pressure of 42.3 kilobars, and a calculated detonation pressure of 33 kilobars.

b. *Ammonaru*. This is the Japanese name for ammonal.

c. *Kokushokuyaku*. This is the Japanese name for black powder.

d. *Chauyaku*. This is the Japanese name for 50/50 cyclotol.

e. *Dainamaito*. This is the Japanese name for dynamite. Japanese dynamites are based on nitroglycerin and are brown to buff in color. Some types of dynamites contain nitrocellulose and others contain diatomaceous earth. Some gelatin dynamites, the so-called faint smoke dynamites, contain borax or salt. Nonfreezing dynamites contain nitroglycol or dinitroglycerol. The Japanese also produce ammonium nitrate and semigelatin dynamites.

f. *Pentoriru*. This is the Japanese term for 50/50 pentolite.

g. *Shoanyaku*. These are a series of mining explosives which consist of the following:

(1) No. 1 contains 70 percent ammonium nitrate, 9 percent dinitronaphthalene, 1 percent woodmeal, and 20 percent salt.

(2) No. 2 contains 79 percent ammonium nitrate, 10 percent dinitronaphthalene, 1 percent saw-dust, and 10 percent sodium chloride.

(3) No. 5 contains 64 percent ammonium nitrate, 12 percent TNT, 3 percent woodmeal, 1 percent wheat starch, and 13 percent sodium chloride.

(4) No. 7 contains 75 percent ammonium nitrate, 9 percent dinitronaphthalene, 1.5 percent TNT, 1.5 percent woodmeal, and 13 percent sodium chloride.

(5) Special contains 64 percent ammonium nitrate, 3 percent dinitronaphthalene, 7 percent TNT, 2 percent nitroguanidine, 2 percent sodium nitrate, 2 percent woodmeal, and 20 percent sodium chloride.

h. *Shotoyaku*. This is the Japanese name for amatol.

11-6. Russian Energetic Materials. Table 11-11 lists some explosives used by Russia.

English	Russian
Lead azide	Azid svintsa
Lead styphnate	Stifnat svintsa, teneres

Table 11-11. Russian Explosives (Cont)

English	Russian
Tetracene	Tetratsin
Mercury fulminate	Gremoochaya rtoof
Guncotton	Khlopchatoboomazhnyi porokh
Pyroxylin (N>12%)	Kolloksilin, piroksilin
Pyrocellulose (11.5% <N <12%)	Piroksilin No. 2, pirokollodion
Nitroglycerin	Nitroglitserin
PETN	Ten
HMX	Okto ghen
RDX	Gheksoghen
Tetryl	Tetril
Ammonium picrate	Pikrat ammoniya, pikrinovokislyi ammonii
TNT	Toe, trotil
Ammonium nitrate	Ammoniynaya selitra

The following energetic materials are used by the Russians.

a. *A or AT*. This is the Russian abbreviation for amatol.

b. *A-IX-2*. This is an explosive mixture used as a projectile filler that contains 73 percent RDX, 23 percent aluminum powder, and 4 percent wax.

c. *Akvanity (Akvanites)*. These are a series of industrial explosives.

(1) Plastic akvanites No. 2 and No. 16 have, in contrast to dynamites, a plasticizing base consisting of an aqueous solution of potassium nitrate thickened to a gel-like consistency in which ammonium nitrate and other constituents (such as combustibles) are also partially dissolved. Their liquid phase at normal temperature is about 20 to 25 percent, of which 5 to 7 percent is water.

(2) Slurry-type akvanite 3L (where L stands for l'yonshchiysya-pourable), uses as a base a thickened aqueous solution of ammonium nitrate making up 45 percent of the liquid phase. Other ingredients are as in dynamites. Akvanite 3L has a liquid-viscous consistency and therefore is suitable for charging descending blastholes and drillholes by the method of casting or by compression under water.

d. *Akvatoly (Akvatols)*. These are industrial slurry explosives. Akvatol 65/35 contains granulated ammonium nitrate as an oxidizer, 27 to 30 percent TNT as a combustible and sensitizer, and 2.5 to 3.5 percent of the sodium salt of carboxymethylcellulose which is a thickening agent. Akvatol M-15 contains granulated ammonium nitrate, 12.5 to 13.2 percent coarse aluminum powder, 21 to 22 percent TNT, and 1.0 to 1.5 percent of the sodium salt of carboxymethyl cellulose. The water content of akvatol slurries must not exceed 13 to 25 percent by weight. In some cases the sodium carboxymethylcellulose can be replaced by other binding agents such as borax or polyacrylamide powder. Akvatols are usually prepared at plants and shipped in the form of anhydrous friable mixtures, packed in paper bags for the addition of water at the site of use. They can also be shipped in ready to use water filled slurries.

e. *Alyumatoly (Alumatols)*. These are combinations of ammonium nitrate, TNT, and aluminum. Russian alumatols are granulated and waterproof. They are used in open cut work for breaking very hard rock.

f. *Alyumit No. 1*. This is a Russian commercial explosive that consists of 80 percent ammonium nitrate, 12 percent TNT, and 12 percent aluminum.

g. *Alyumotol*. This is a granulated melt of TNT and aluminum.

h. *Amatol*. This is the same as amatol in English.

i. *Ammoksily or Ammoxyly*. This is a nonpermissible mining explosive that consists of ammonium nitrate and trinitroxylylene.

j. *Ammonaly*. This is the Russian name for ammonals.

k. *Ammonity (Ammonits)*. Ammonits are ammonium nitrate mixtures of powdered structure in which TNT or other aromatic nitrocompounds are used as the explosive sensitizer and fuel. In grain or granulated form they are known as zernogranulity. The most current ammonits are:

(1) No. 6-ZhV and No. 7-ZhV are waterproof. The composition of the two is:

	No. 6	No. 7
Ammonium nitrate (%)	79	81.5
TNT (%)	21	16
Woodmeal (0/o)	-	2.5

(2) PZhV-20, AP-4ZhV, and AP-5ZhV are

rock oriented. The composition of these is shown in table 11-12.

Table 11-12. Some Ammonits Formulations

	PZhV-20	AP-4ZhV	AP-5ZhV
Ammonium nitrate (%)	64	68	70
TNT (%)	16	17	18
Flame inhibitor (%)	20	15	12

(3) Ammonit skal'nyi No. 1 is used in the pressed state for blasting hard rocks in open or underground works.

(4) Ammonit V-3, shnekovannyi is used in flooded drill holes.

(5) No. 9-2hV and No. 10-ZhV are waterproof mixtures used for blasting soft or medium rocks. Their compositions are:

	No. 9	No. 10
Ammonium nitrate (%)	87	85
TNT (%)	5	8
Woodmeal (%)	8	7

(6) Ammonit sernyi No. 1 -ZhV, for use in sulfur mines, consists of 52 percent waterproof ammonium nitrate, 11.5 percent TNT, 1.5 percent woodmeal, 5 percent of a mixture of low freezing point nitroesters, and 30 percent flame inhibitor.

(7) Ammonit neftyanyoy No. 3-ZhV, for use in mines with petroleum vapors, consists of 52.5 percent ammonium nitrate, 7 percent TNT, 1.5 percent calcium stearate, 30 percent flame inhibitors, 9 percent nitroesters, 0.3 percent collodion cotton, and 0.2 percent soda.

(8) Ammonit T-19, a safety explosive used in fiery mines, consists of 61 percent waterproof ammonium nitrate, 19 percent TNT, and 20 percent flame inhibitor.

(9) Shashki (demolition charges) skal'nago ammonita are compressed charges which serve as intermediate initiators for detonating nearly insensitive explosives.

l. Ammonit Predokhranitel'nyi. This is a safety commercial mine explosive which consists of 68 percent ammonium nitrate, 10 percent TNT, 2 percent powdered pine bark or oil cake, and 20 percent sodium chloride.

m. Ammonit V-3V Poroshke. This is a powdered explosive that contains 82 percent nonwaterproofed ammonium nitrate, 16.5 percent TNT, 1 percent asfal'tit, and 0.5 percent paraffin.

n. *Ammontol*. This is a castable high explosive mixture of 50 percent ammonium nitrate, 38 percent TNT, and 12 percent trinitroxylyene that is used for loading some projectiles.

o. *Belity (Bellites)*. These are extensively used commercial mining and blasting explosives. The following compositions are used; 35 percent ammonium nitrate and 65 percent dinitrobenzene, 87 percent ammonium nitrate and 13 percent dinitrobenzene, and 80 percent ammonium nitrate, 12 percent trinitroxylyene, and 8 percent dinitrobenzene.

p. *Buryi Shokoladnyi Porokh*. These are the Russian brown powders. Brown powders are very similar to black powders except that the charcoal is brown because carbonization is only carried out to 70 to 75 percent. This is called buryi porokh, and is slower burning than black powder. A still slower brown powder is shokoladnyi porokh which has charcoal with a carbon content of 52 to 54 percent. Brown powders have been used in delay compositions and for time rings of fuses. The composition of some of these brown powders is listed in table 11-13.

Table 11-13. Russian Brown Powders

	No. 1	No. 2	No. 3
Brown coal (%)	4	6	7
Potassium nitrate (%)	59	67	76
Sulfur (%)	37	27	17
Velocity of burning (millimeters per second)	3	3.8	3.4

q. *Charnyi Porokh*. This is Russian for black powders which are also called pymnyi (smoke) porokh. Table 11-14 lists typical compositions.

Table 11-14. Russian Black Powders

	KNO ₃	Sulfur	Charcoal
Military (%)	75	10	15
Fuse powder (%)	78	12	10
Blasting (%)	75 - 84	8 - 10	8 - 15
Blasting (%)	66.6	16.7	16.7
Tubular (%)	60 - 75	13 - 37	4 - 7
Sulfurless (%)	80	-	20
Sporting (%)	74 - 78	8 - 10	14 - 16
Sporting (%)	80	8	12

r. *Detonity*. These are powdery, water resistant explosives used in hard rock blasting. Table 11-15 lists typical compositions.

Table 11-15. Detonity

Designation	6A	10A	15A - 10
Low freezing point			
organic nitrates (%)	6.0	10.0	14.7
Ammonium nitrate (water resistant ZhV) (%)	78.0	76.0	74.0
TNT (%)	11.0	8.0	-
Aluminum powder (%)	5.3	5.2	10.0
Calcium stearate (%)	0.7	0.7	1.0
Collodion cotton (%)	-	0.1	0.3
Soda (added above 100%)	0.2	0.2	0.2
Density, grams per cubic centimeter	1.1	1.1	1.1
Detonation velocity, meters per second	4,000	4,200	4,300

s. *Dinaftalit*. This is an explosive mixture that is used to fill shells and as a commercial blasting agent. Dinaftalit contains 88 percent ammonium nitrate, 11.6 percent dinitronaphthalene, and 0.4 percent paraffin.

t. *Dinitronaftalin*. This is Russian for dinitronaphthalene. This explosive is very weak and has an unsatisfactory oxygen balance. Dinitronaphthalene is not used alone, but is used as an ingredient in several composite explosives.

u. *Dinamity*. These are the Russian dynamites. The following types are used:

(1) Gremuchii studen' is a blasting gelatin that contains 87 to 93 percent nitroglycerin and 7 to 13 percent collodion cotton.

(2) Plasticheskii dinamit is a plastic dynamite that contains 62 to 83 percent nitroglycerin, 3 to 6 percent collodion cotton, 27 to 29 percent potassium or sodium nitrate, and 2 to 8 percent woodmeal.

(3) Grisutin contains 12 to 30 percent nitroglycerin gelatinized by collodion cotton and 70 to 88 percent ammonium nitrate with an absorbent such as limestone or sawdust.

(4) AM-8 contains 89 percent ammonium nitrate, 8 percent paraffin, and 3 percent mineral oil.

(5) AM-10 contains 87.7 percent ammonium nitrate, 10 percent paraffin, and 2.3 percent mineral oil.

v. *Grammonal*. These are powerful, granulated ammonals with an increased aluminum content. They are used in open pit blasting of hard rocks.

w. *Granulity*. These are granulated mining explosives. Typical compositions are given in table 11-16.

Table 11-16. Granulity

Components, granulites:	AC-8	AC-4	C-2	M
Ammonium nitrate, granulated (%)	89.0	91.8	92.8	94.5
Aluminum, powdered (%)	8.0	4.0	-	-
Woodmeal (%)	-	-	3.0	-
Mineral oil (%)	3.0	4.2	4.2	5.5
Detonation velocity, meters per second	3,000	2,600	2,400	2,500
Trauzl test value, cubic centimeters	410	390	320	320

x. *Igdanit*. This is an ammonium nitrate, fuel oil explosive that is prepared in situ just before use. Reported compositions vary from an ammonium nitrate composition of 94 to 97 percent.

y. *Mansit*. This is an explosive mixture that consists of 72 percent ammonium nitrate, 23 percent ammonium picrate, and 5 percent petroleum asphalt.

z. *Miporit*. This is an explosive used in gaseous mines that contains 65 percent waterproofed ammonium nitrate, 15 percent TNT, 18 percent flame inhibitor, and 2 percent foamed urea-formaldehyde resin.

aa. *Pobedit VP-4*. This is a permissible explosive used in fire damp mines that consists of 65.5 percent water resistant ammonium nitrate, 9.0 percent low freezing point organic nitrates such as nitroglycerin and nitroglycol, 12 percent TNT, 12 percent flame extinguisher, 1.5 percent woodmeal, 0.13 percent collodion cotton, 0.1 percent calcium stearate, and 0.1 percent soda.

bb. *Selectite No. 1 (Celekitit No. 1)*. This is a granulated, friable, water resistant ammonium nitrate explosive with 10 percent low freezing point nitrate esters.

cc. *Slurry Explosives*. These consist of ammonium nitrate in a thickened, water based suspension described in Chapter 8. Akvatols 65/35 and M-15 are considered slurry explosives.

dd. *Tetritoly*. This is Russian for tetrytol.

ee. *Uglenity*. These explosives, which are also called ooglenity, are coal mining explosives used in firedamp and dusty environments. They are ammonium nitrate based.

ff. *Zernogranoolity*. Waterproof ammonium nitrate explosives used for blasting rock of moderate hardness or hard rock on flooded faces.

11-7. Spanish Energetic Materials. Table 11-17 lists some of the explosives used by the Spanish.

Table 11-17. Spanish Explosives

English	Spanish
Lead azide	Azido de plomo, nitruro de plomo, plumbazida
Lead styphnate	Stifnato de plomo, trinitroresorcinato de plomo, triginato, tricinato
Tetracene	Tetraceno
Mercury fulminate	Fulminato de mercurio
Collodion cotton (N about 12%)	Algodon colodio, cotone colodio
Guncotton (N>12%)	Algodon fulminate, algodon polvora, fulmicoton
Nitroglycerin	Nitroglicerina aceite explosivo
PETN	Pentrita, nitropenta, nitropentaeritrita
RDX	Hexogeno, T4, exogeno, ciclonita
Tetryl	Tetralita, tetralo, tetranitrometilanelina
Ammonium picrate	Picrato amonico
TNT	Trilita, trotilo, tol, trinitrotolueno
Ammonium nitrate	Nitrato amonico

The following explosives are used by the Spanish.

a. *Amatolos*. This is Spanish for amatols.

b. *Amonales*. This is Spanish for ammonal.

c. *Amonitas*. These are explosives that contain from 50 to 100 percent ammonium nitrate, other nitrated products, and a small portion of other substances such as nitroglycerin, sawdust, and dichromates. Some explosives of this type are called explosivos favier, australita roburita, donarita, and perdita. Such mixtures are somewhat more sensitive to shock and friction and have a lower rate of detonation than other ammonium nitrate explosives. Their hygroscopicity and relative instability in prolonged storage are the principal disadvantages. They are used in mining operations and as main charges in some projectiles.

d. *Anagon*. This is an ammonal type explosive which contains 70 percent ammonium nitrate, 20 percent aluminum zinc alloy, and 10 percent charcoal.

e. *Antigrisu Explosives*. These are permissible explosives also known as explosivos de seguridad. Table 11-18 lists some compositions.

Table 11-18. Spanish Artigrisu Explosives

	No. 1	No. 2	No. 3
Ammonium nitrate (%)	80.6	80.9	82.0
Dinitronaphthalene (%)	6.4	11.7	
Ammonium chloride (%)	13.0	7.4	13.0
Trinitronaphthalene (%)	-	-	5.0

f. *Baratol*. These are high explosives that contain from 10 to 70 percent barium nitrate and TNT. They are used as bursting charges.

g. *Dinamitas*. This is Spanish for dynamite. These are considered industrial explosives. Spanish dynamites can be divided into two groups with variable composition.

(1) *Dinamitas a base inerte* are dynamites with an inert base. To this class belong the compositions containing 75, 50, or 30 percent nitroglycerin with kieselguhr. They are called number 1, 2, and 3 depending upon the nitroglycerin content. Dynamite 3 is the most popular type.

(2) *Dinamitas a base activa* are dynamites with an active base. These dynamites contain a combustible material or explosive material as the active base. The type of base material further divides these into classes.

(a) *Dinamitas a base de nitratos* use nitrates of ammonium, sodium, or potassium and a combustible such as carbon, sawdust, or flour.

(b) *Dinamitas a base de chloratos* use potassium or sodium chlorate in place of nitrates.

(c) *Dinamitas gelatinas* contain collodion cotton in sufficient proportion to gelatinize the nitroglycerin. Compositions that contain only nitroglycerin and collodion cotton are called *goma*. All others are called *gelatina dinamita*, *nitrogelatina*, or simply *gelatina*. If a dynamite less sensitive than *gomas* is desired, three to five percent camphor is added. Such compositions are called *gelatinas explosivas de guerra* (military gelatins).

h. *Dinamones*. *Dinamones* are permissible explosives similar to *amonitas* except that they do not contain aluminum or aromatic nitrocompounds.

i. *Donarita*. This is a mining explosive that contains 80 percent ammonium nitrate, 12 percent TNT, 4 percent gelatinized nitroglycerin, and 4 percent woodmeal.

j. *Explosivos clorato*. This class of explosives contains 60 to 80 percent chlorates or perchlorates of sodium, potassium, or ammonium mixed with a combustible material such as carbon, sulfur, or

aluminum. Organic combustibles such as vaseline, paraffin, or oils may also be used. These explosives are similar to ammonium nitrate but have a greater packing density and are more sensitive to impact. The explosives are used as a substitute for dynamite in mining operations.

k. *Explosivo Plastico "La Maranosa"*. This plastic explosive consists of 85 percent RDX, 5.5 percent rubber, and 9.5 percent gelatinizing oil. The composite is of low sensitivity. At 200°C decomposition without explosion occurs but with the evolution of heavy nitrous fumes. A carbonaceous residue is left.

l. *Hexogeno Plastico*. These are also called *plastex* or *PE*. They correspond to American composition C. The explosive is prepared by coating granular RDX with 12 percent vaseline and other oily substances. The product is a yellow colored, plastic material which can be cut, perforated, and handled without extra precaution. Initiation is relatively easy with a blasting cap or various detonators. In extreme climates this explosive must be stored in protected areas. No casing is required in some demolition applications.

m. *Hexonitas*. These consist of 80 or 50 percent RDX and 20 or 50 percent nitroglycerin. The 50/50 composition can be further gelatinized and plasticized with some collodion cotton. A mixture of 50 percent RDX, 46 percent nitroglycerin, and 4 percent collodion cotton is called *hexonita gelatinizada*.

n. *Qxiliquita y Aire Liquido*. This is an explosive of liquid oxygen or liquid air with finely pulverized charcoal, cork dust, or other absorbent fuel.

o. *Polvoras Negras*. This is Spanish for black powder. Spanish black powders are divided into three groups.

(1) *Polora de guerra*, military black powder, contains 75 percent potassium nitrate, 12.5 percent charcoal, and 12.5 percent sulfur.

(2) *Polvora de caza*, sporting powder, contains 80 percent potassium nitrate, 11 percent charcoal, and 9 percent sulfur.

(3) *Polvora de mina*, blasting powder, contains 80 percent potassium nitrate, charcoal, and sulfur. The exact percentages of charcoal and sulfur are unknown.

p. *Tetritol*. This is Spanish for tetrytol. The Spanish use tetrytol as a bursting charge and as a booster.

q. *Tonita*. This is a mixture of 68 percent barium nitrate, 13 percent dinitrobenzene, and 19 percent gun-cotton.

r. *Triplastita*. This is a gelatinized mixture of dinitrotoluene and guncotton that is less sensitive and more dense than TNT. Triplastita is used as a bursting charge in some ammunition.

s. *Tritolita*. This is Spanish for 50/50 cyclotol.

t. *Tritolital*. This explosive, also called torpex, is a castable mixture of 60 percent TNT, 20 percent RDX, and 20 percent aluminum. Tritolital is used as a bursting charge in depth charges and bombs.

11-8. Swedish Energetic Materials. As in the United States, Sweden's explosive industry consists of both privately owned and government facilities. Together they provide virtually all of the country's explosives plus significant amounts for export. The only items obtained abroad are initiating components such as primers and detonators. Sweden, however, is heavily dependent on imports for certain basic raw materials such as petroleum, coal, coke, cotton, sulfur, and others. Table 11-19 lists some of the explosives used by the Swedish.

Table 11-19. Swedish Explosives

English	Swedish
Lead azide	Blyazid, blyacid
Lead styphnate	Blystyfnat, blytrinitroresorcinat
Tetracene	Tetrazen
Mercury fulminate	Knallkvicksilver
Nitrocellulose	Nitrocellulosa
Pyroxylin	Piroxilina
Nitroglycerin	Nitroglycerin
RDX	Hexogen
PETN	Pentyl
Tetryl	Tetryl
TNT	Trotyl

a. *Ammongelatin Dynamit*. This is a gelatin dynamite. One formulation contains 71 percent nitroglycerin, 4 percent collodion cotton, 23 percent ammonium nitrate, and 2 percent charcoal. Another formulation contains 25 percent nitroglycerin, 1 percent collodion cotton, 62 percent ammonium nitrate, and 12 percent charcoal. The first of these two compositions is gelatinous while the second is crumbly and plastic. The basic formulations change by incorporating other explosives such as liquid DNT, TNT, trinitroxyline, nitrostarch, or nitroglycols. Such additives act not only as sensitizers for ammonium nitrate, but some also serve as antifreeze compounds.

b. *Ammoniakktrut*. This is an ammonium nitrate dynamite that consists of 80 percent ammonium nitrate and 20 percent charcoal. A modification of this mixture contains 80 percent ammonium nitrate, 12 percent nitroglycerin, and 8 percent charcoal. This modified mixture has been used somewhat but was found to be hygroscopic and exuded.

c. *Blastin*. This is a cheddite type safety explosive consisting of 63 percent ammonium perchlorate, 23 percent sodium nitrate, 8 percent DNT, and 6 percent paraffin. Blastin is reported to be 50 percent more powerful than dynamite and has been used extensively as a blasting and demolition explosive.

d. *Bonit*. This is Swedish for cyclotol. Three mixtures of RDX/TNT have been used: 50/50, 70/30, and 60/40.

e. *Bonocord*. This is a Swedish detonating cord which consists of a PETN core covered with braided cotton threads and protected by an outer coating of plastic which is based on polyvinyl chloride or polyethylene. Bonocord weighs 30 grams per meter and has an outer diameter of 5.5 millimeters. The quantity of PETN is 12 grams per meter. The detonation velocity is 6,000 to 7,000 meters per second. Bonocord is initiated with a number six exploder and is used for direct detonation of all types of explosive charges.

f. *Gelatinerad Dynamit*. These are gelatin dynamites. A typical composition is 62.5 percent nitroglycerin, 2.5 percent collodion cotton, 27 percent potassium nitrate, and 8 percent woodmeal.

g. *Hexotol*. This is the specific Swedish name for 60/40 cyclotol. Hexotol is considered a bonit and is used as a cast bursting charge in shells, land mines, demolition charges, boosters, and other military applications.

h. *Hexotonal*. This name is applied to several torpex type mixtures used as bursting charges. Some known compositions are listed in table 11-20.

Table 11-20. Hexotonal

	No. 1	No. 2	No. 3
RDX (%)	40	40	30
TNT (%)	44	40	50
Al (%)	15	15	20
Refined paraffin wax (%)	1	5	-
Wax added to mixture (%)	-	-	1
Carbon black added to mixture (%)	-	-	1.5

i. *Nobelit*. This is a permissible gelatin dynamite containing 28 percent nitroglycerin, 1 percent collodion cotton, 40 percent ammonium nitrate, 13.5 percent combustibles (such as flour, woodmeal, and dextrin), 17 percent sodium chloride, and 0.5 percent vegetable oil.

j. *Reolit A, B, C, D, or Eand Reomex A or B*. These are trade names for slurry blasting explosives.

k. *Seramin*. This is an ammonium nitrate dynamite consisting of 72.5 percent ammonium nitrate, 18 percent nitroglycerin, 8.7 percent sawdust or charcoal, and 0.8 percent benzene or creosote.

l. *Sprangdeg*. These are plastic explosives that usually contain RDX or PETN with a desensitizing oil and special plasticizers. One such explosive consists of 84 percent PETN and 16 percent mineral oil that is mixed by a special procedure. The product is moldable at temperatures below -1 50C.

m. *Spranggelatin*. This is a blasting gelatin that is prepared by dissolving seven to eight percent collodion cotton in slightly warm nitroglycerin. On cooling, a stiff jelly is formed that is one of the most powerful explosives known.

n. *Startex A*. This is another slurry blasting agent.

o. *Svartrkrut*. This is Swedish for black powder. The composition falls within the following limits: potassium nitrate 74 to 78 percent, charcoal 12 to 15 percent, and sulfur 10 to 12 percent. For different grades of black powder, charcoals of different origin and methods of preparation are used. Powders used in shotgun shells contain charcoal from black alder carbonized in furnaces. Ordinary powders use charcoal made from birch, alder, willow, or linden and blasting powders use pinewood charred in kilns or furnaces.

p. *Territ*. This is a cheddite type blasting explosive that consists of 43 percent ammonium perchlorate, 28 percent sodium nitrate, 27.8 percent liquid DNT/TNT,

and 1.2 percent collodion cotton. Another formulation is 43 percent ammonium chlorate, 26 percent ammonium nitrate, and 31 percent of a mixture that contains 96 percent TNT and 4 percent nitrocellulose. Territ is comparable in properties to some low freezing point dynamites and is safe to handle. The brisance of the mixture is such that in mining coal or other mining operations, no small dust particulates are formed. Territ is sometimes difficult to detonate so present formulations contain some nitroglycerin.

11-9. Swiss Energetic Materials. In Switzerland the production of black powder and propellants is a monopoly of the government. The Swiss government, however, does not manufacture explosives except for small quantities of primary explosives. Commercial firms produce the explosives used by the army under strict control by military authorities. Switzerland does not generally export military explosives, however, during times of low usage some export has taken place to keep facilities open. Table 11-21 lists some of the explosives used by the Swiss.

Table 11-21. Swiss Explosives

English	Swiss
Lead styphnate	Bleitrinitroresorzinat, bleistyphnat
Nitroglycerin PETN	Nitroglycerin Pentaerythrit-tetranitrat, nitropentaerythrit, pentrit
TNT	Trinitrotoluol, trotyl

a. *Aldofit*. This is a permissible explosive that contains 81 percent ammonium nitrate, 17 percent TNT, and 2 percent woodmeal.

b. *Ammonpentrinit*. These are blasting explosives with the compositions shown in table 11-22.

Table 11-22. Ammonpentrinit

Compositions	1	2	3	4	5
PETN (%)	40.9	40.6	37.0	31.0	33.8
Nitroglycerin (%)	40.9	7.6	7.2	7.5	50.7
Nitroglycol (%)	-	2.6	2.0	-	-
Collodion cotton (%)	1.6	-	0.8	0.5	0.5
Ammonium nitrate (%)	16.6	47.5	48.0	59.0	15.0
DNT (liquid) (%)	-	-	5.0	-	-
Vaseline (%)	-	1.7	-	2.0	-

Compositions with collodion cotton are also called gelatinepenthrinit. Aluminum can be incorporated to increase the blast effect of the explosives.

c. *Amolit*. This is the trade name of a free flowing bulk packaged ANFO.

d. *Detonierende Zundschnur (Krallzundschnur)*. This is Swiss for detonating cord. One such cord contains a core of PETN or RDX in a gel of collodion cotton and a liquid explosive such as nitroglycerin or nitroglycol. This formulation is coated on several textile threads and covered with a fabric coating.

e. *Gelatine Cheddit*. This is a plastic chlorate explosive which contains 79 percent sodium chlorate, 5 percent of a liquid mixture of castor oil that coats the sodium chlorate, 2 percent liquid DNT, and 14 percent TNT that has been preheated to 40°C. Some collodion cotton may also be incorporated into the mixture.

f. *Gelatine Penthrinit*. These are plastic, nonexudable, explosive blends of PETN and nitroglycerin and other ingredients. If the amount of PETN in the formulation is below 60 percent, 6 to 7 percent collodion cotton is added to improve plasticity. Compositions of some of the gelatine-penthrinit and penthrinit are given in table 11-23.

g. *Hexal*. This is an antiaircraft ammunition filler

that contains RDX and aluminum. The aluminum is coated with a water insoluble wax to prevent wateraluminum reactions that release hydrogen.

h. *Hexonite*. These are plastic explosives. One formulation consists of from 20 to 50 percent RDX and 80 to 50 percent nitroglycerin. Another formulation consists of 50 percent RDX, 46 percent nitroglycerin, and 4 percent collodion cotton.

i. *Matter Explosives*. These explosives are named after their inventor O. Matter. One explosive is a gelatin dynamite that consists of tar distillates mixed with inorganic oxidizers such as nitrates, chlorates or perchlorates. Another formulation uses water soluble chlorinated hydrocarbons such as chloronaphthalene as a fuel with a thickening agent.

j. *Nitrogelatinedynamit*. These are the gelatin dynamites that contain 20 to 25 percent nitroglycerin gelatinized with collodion cotton, ammonium nitrate, and a liquid aromatic nitrocompound serving as a sensitizer. The nitroglycerin may be a 4:1 mixture of nitroglycerin and an antifreeze such as nitroglycol. The liquid aromatic nitrocompound may be drip oil which is a byproduct of TNT manufacture. Some explosives which belong to the class sicherheitsdynamite (safe to handle and transport) include aldorfit, gamsit, and telsit.

Table 11-23. Penthrinit

Composition and properties	Penthrinit						Gelatine penthrinit			
	1	2	3	4	5	6	1	2	3	4
PETN (%)	80	85	70	50	40	80	50	59.0	15.5	50
Nitroglycerin (%)	20	15	30	50	60	15	46	24.7	77.5	46
Nitroglycol (%)	-	-	-	-	-	5	-	-	-	-
Collodion cotton (%)	-	-	-	-	-	-	4	0.6	7.0	4
NH ₄ ClO ₄ (%)	-	-	-	-	-	-	-	15.7	-	-
Al (added) (%)	-	-	-	-	-	-	-	-	-	30

k. *Nizol*. This is an explosive that contains meta dinitrobenzene made more sensitive to initiation by the addition of 30 percent PETN. The mixture is castable because of meta dinitrobenzene's low melting point, 80°C.

l. *Pentostit*. This is the trade name for a military explosive in which PETN is desensitized with pentaerythritol tetrastearate.

m. *Pentro*. This is petrotolite, which is also called pentryl.

n. *Plastolit*. This is a safe to handle plastic explosive that contains 57 percent sodium nitrate, 15 percent nitroglycerin, 4 percent nitroglycol, 1.3 percent collodion cotton, 13 percent liquid DNT, 9.6 percent woodmeal, and 0.1 percent sodium bicarbonate.

o. *Totalit*. This is a military explosive used as a bursting charge that contains 95.5 percent ammonium nitrate and 4.5 percent paraffin wax.

p. *Tramex*. This is the trade name for a powdered nitroglycerin sensitized explosive.

CHAPTER 12

TOXICITY OF ENERGETIC MATERIALS

12-1. General. This section contains general information about toxicity of military explosives. All tables indicating quantity distance separations, minimum distances, etc., have been removed from this

manual. Applicable information may be found in DoD 6055.9STD, Ammunition and Explosives Safety Standards.

12-2. Toxicity of United States Military Explosives.

a. Many explosives, because of their chemical structures, are somewhat toxic. To be acceptable, a military explosive must be of minimum toxicity. Careful attention must be paid to this feature because the effects of

toxicity may vary from mild dermatitis or a headache to serious damage to internal organs.

b. Table 12-1 is a concise presentation of the toxicological properties of selected United States military explosives.

Table 12-1. Toxicity of United States Military Explosives

Explosive	Health hazard	Protective measures
<i>Initiating explosives</i> Lead azide	Lead azide is not considered to be particularly toxic but inhalation of the dust should be avoided since this causes a headache and distention of the blood vessels.	Avoid inhalation. Tolerance level below 0.2 milligrams per cubic meter in air.
Mercury fulminate	Poisoning has symptoms of mercury poisoning. At low levels causes dermatitis and irritation of the mucous membranes.	Avoid all routes of exposure. Tolerance level below 0.01 milligrams per cubic meter in air.
<i>Boostering explosives</i> PETN	PETN is not unduly toxic since it is nearly insoluble in water and usually is handled while wet. It, therefore, cannot be absorbed through the skin and inhalation of the dust is improbable. Tests have shown that small doses of PETN cause decrease in blood pressure; larger doses cause dyspnea and convulsions.	
Tetryl	Moderately toxic by inhalation or ingestion. Tetryl has a strong coloring action on the human skin and can cause a dermatitis. Inhalation of tetryl dust has recognized toxic effects.	Avoid inhalation or ingestion. To minimize these effects, use cold cream containing 10 percent sodium perborate. Avoid inhalation. Tolerance level below 1.5 milligrams per cubic meter in air.

Table 12-1. Toxicity of United States Military Explosives (Cont)

Explosive	Health hazard	Protective measures
RDX	<p>Munitions workers have experienced acute RDX intoxication, mainly from inhaling the fine particles; ingestion may have been a contributing factor. Troops have occasionally suffered symptoms of RDX intoxication following consumption of Composition C-4, a plastic explosive containing 91 percent RDX. Composition C-4 was chewed by soldiers to produce the "high" of ethyl alcohol or it was used as a fuel for cooking. In the latter case, the victims may have inhaled the fumes or inadvertently introduced RDX into their food. Acute effects were seen within a few hours of exposure, ie, after a latent period. The course of acute RDX poisoning appears to follow a general sequence, though some symptoms may be missing in any individual case: restlessness and hyperirritability; headache; weakness; dizziness; severe nausea and vomiting; aggravated and prolonged epileptiform seizures (generalized convulsions) which are often repeated; unconsciousness between or after convulsions; muscle twitching and soreness; stupor, delirium, disorientation and confusion; then gradual recovery accompanied in the beginning by amnesia. In a few cases, workers have suffered irritation to the skin, mucous membranes, and conjunctivae by fine particles of RDX.</p> <p>The clinical findings in RDX intoxication may include fever; rapid pulse; hematuria due to effects on the proximal tubules of the kidney; proteinuria; azotemia; occasional mild anemia; neutrophilic leukocytosis; elevated SGOT (serum glutamic oxalacetic transaminase), which may explain the muscle soreness; nitrites in the gastric juices; and electroencephalographic abnormalities. There appears to be no liver involvement and cerebrospinal fluid is normal. Patients evidently recover completely from the effects of RDX poisoning, the length of time depending on the extent of exposure. The period of recovery varies from a few days to about three months. Thus, RDX intoxication involves gastrointestinal, central nervous system, and renal effects. The potential routes of exposure are inhalation of fine particles or fumes, or ingestion. Because RDX is a high-melting solid and not very lipid soluble, skin absorption is very unlikely. Although the symptoms may be severe, deaths have apparently been quite few, and no permanent damage seems to have resulted among survivors.</p>	Avoid inhalation or ingestion.

Table 12-1. Toxicity of United States Military Explosives (Cont)

Explosive	Health hazard	Protective measures
<i>Bursting charge explosives</i> Amatol	Highly to moderately toxic by inhalation, ingestion, and absorption. Contact may cause dermatitis.	Avoid inhalation, ingestion, or skin contact.
Ammonium picrate	Highly toxic by inhalation, ingestion, and skin absorption.	Inhalation of the dust should be minimized and frequent baths and changes of clothes are desirable for those working with the material in quantity.
DBX	Generally considered non toxic.	
HBX-6 or H-6	Highly toxic by inhalation or ingestion.	Avoid inhalation and ingestion.
HMX	The low solubility of HMX has caused difficulties that have cast in doubt the validity of all toxicological research done on this compound to date. It would appear that, weight-for-weight, HMX is somewhat less toxic than RDX but exhibits similar effects. Experiments are in progress to confirm or contradict this opinion.	
Pentolite	See TNT and PETN.	
Picratol	See TNT and ammonium picrate.	
RDX compositions	See RDX - boosting explosives.	
Tetrytol	See TNT and tetryl.	
TNT	TNT exposures can occur by inhalation of the dust, through ingestion, and via skin absorption. Among the first signs of TNT intoxication are changes in the blood: the red blood cell count and hemoglobin content decrease; abnormal red cells are seen; and there is a transitory increase in leukocytes and lymphocytes. Rashes and skin eruption may be associated with these effects. Increased capillary fragility leads to nose bleeds and hemorrhages of the skin and mucosa. At sufficiently high and prolonged exposures, more serious blood phenomena appear. These include methemoglobinemia, with consequent cyanosis; hyperplasia of the bone marrow leading to aplastic anemia (because the marrow no longer produces blood cells); and a drastic loss of blood platelets. Petechiae often occur in conjunction with aplastic anemia.	Avoid inhalation and skin contact. Tolerance level below 1.5 milligrams per cubic meter in air.

Table 12-1. Toxicity of United States Military Explosives (Cont)

Explosive	Health hazard	Protective measures
	<p>A second type of symptom, toxic jaundice, indicates toxic hepatitis. This ultimately leads to yellow atrophy of the liver.</p> <p>Death can occur from either anemia or (especially in younger people) toxic hepatitis.</p> <p>Effects of TNT on the kidney are manifest in increased filtration rates. In mild cases of TNT intoxication, urgency, frequent urination, and lumbar pain may be the only symptoms.</p> <p>Individuals exposed to TNT may complain of a constant bitter taste, excessive salivation, nausea, vomiting, and gastritis. The latter is due to reduced secretion of pancreatic eazymes.</p> <p>According to European accounts, chronic work-place exposure to TNT was associated with cataracts of the eyes. There have been various reports of central nervous system intoxication (neurasthenia, polyneuritis). No carcinogenic effects of TNT on human beings have been reported.</p>	
Torpex	See TNT.	
Tritonal	Highly toxic by inhalation and ingestion.	Avoid inhalation and ingestion.
<i>Solid propellants</i>		
<i>Single-base propellants</i>		
Nitrocellulose	<p>Nitrocellulose is a water-insoluble fibrous polymer. Consequently it is not absorbed through the intestinal wall or cell membranes. This accounts for its total lack of oral toxicity to mammals. Subchronic and chronic feeding to rats and dogs at contents as high as 10 percent and to mice at 3 percent of the solid diet resulted in no effects other than those of fiber bulk, ie, as if they had been fed cotton linters.</p> <p>Suspended nitrocelluldse in concentrations as high as 1,000 milligrams per liter showed no effect on four species of fish and four invertebrates in various acute toxicity tests.</p>	Adequate ventilation is recommended.

Table 12-1. Toxicity of United States Military Explosives (Cont)

Explosive	Health hazard	Protective measures
<i>Double-base propellants</i>		
Nitrocellulose	See nitrocellulose above.	
Nitroglycerin	<p>Nitroglycerin has been used as a vasodilator drug in medicine, especially for the treatment of angina; thus, there is a fairly extensive literature on its biochemical and clinical aspects. The most common medicinal dose is 0.65 milligrams (roughly 0.01 milligrams per kilogram), but many patients safely receive 20 times this (about 0.2 milligrams per kilogram) daily. Survival has been noted after quantities up to 400 milligrams (about six milligrams per kilogram) were administered orally or sublingually. Two of the more noticeable symptoms are headache and falling blood pressure.</p> <p>Chronic human exposure to nitroglycerin is characterized by methemoglobinemia and the development of tolerance to the drug. Withdrawal from frequent exposure to nitroglycerin causes severe headaches, "Monday head," among munitions workers.</p> <p>Since nitroglycerin is not very volatile, skin absorption is the most likely route of exposure. A TLV of 0.2parts per million, or 2 milligrams per cubic meter, in air was adopted by the American Conference of Government Industrial Hygienists in 1972, to encompass cutaneous exposure - including mucous membranes and the eye - as well as inhalation. But a reduction in this value may be desirable in view of withdrawal headaches suffered by volunteers after exposure to such a level.</p>	Avoid inhalation or skin contact.
<i>Military pyrotechnics</i>		
HC smoke mixtures	Moderately toxic by inhalation and ingestion. Skin contact can cause dermatitis.	Avoid inhalation, ingestion, and skin contact.
Black powder	Moderately toxic by inhalation and ingestion.	Avoid inhalation and ingestion.

Change 3 12-5/(12-6 blank)

(12-7 thru 12-30 deleted)

CHAPTER 13
DETECTION AND IDENTIFICATION OF ENERGETIC MATERIALS

13-1. Introduction. This chapter discusses the methods used to detect and identify energetic materials. Almost all of the analytical chemistry techniques are used. Normally, identification involves a series of tests, each providing a clue to the identity of the compound. In addition to the techniques discussed in this chapter, identifying information can be obtained from physical properties such as melting point, crystalline structure, density, physical state, color, and indices of refraction.

13-2. Wet Chemical Methods. When a test sample is treated with an appropriate reagent, a coloration is produced which is characteristic of the compound being tested. These reactions are known as color reactions and may help identify the sample. The compound which produces the color change is called the color reagent. Color reactions are used to some degree for preliminary identification and confirmation but have largely been replaced by the more modern instrumental techniques. Table 13-1 lists some of the common color reactions used to identify explosives.

Table 13-1. Color Tests

Water Solution or Extract of Energetic Material				Solid of Energetic Material		
	Color of solution	Color of universal pH test	Color of precipitate with Nessler's reagent	Color effect of test with solution of-		
				Ethylenediamine	Diphenylamine	Thymol
TNT	(Insoluble)	-	-	Maroon	Colorless	-
Tetryl	(Insoluble)	-	-	Red	Blue	Green
Picric acid	Yellow	Red	(No ppt)	Orange	-	-
Explosive "D"	Yellow	-	Brown	Orange	-	-
Haleite	None	-	(No ppt)	None	Blue ¹	Orange
Nitroguanidine	None	-	White	-	Blue	Green
Ammonium nitrate	None	-	Brown	None	Dirty green	Green ¹
PETN	(Insoluble)	-	-	None	Dirty green	Green
Nitroglycerin	None	-	(No ppt)	-	Deep blue	Green
DEGN	None	-	(No ppt)	-	Deep blue	Brown ²
Nitrocellulose	None	-	-	-	Blue	Green
Tritonal	(Insoluble)	-	-	Maroon	Colorless	-
Tetrytol	(Insoluble)	-	(No ppt)	Maroon	Intense blue	Green
Picratol	Yellow	-	Brown	Maroon	-	-
Ednatol	None	Orange	(No ppt)	Maroon	Intense blue	Orange
Amatol	None	-	Brown	Maroon	Dirty green	Green
Ammonal	None	-	Brown	Maroon	Dirty green	Green
Pentolite	None	-	(No ppt)	Maroon	Dirty green	Green
Black powder ³	None	No change-	-	-	Blue	Green

¹Color appears immediately.

²Sometimes explodes mildly (puffs) upon addition of sulfuric acid.

³Tests of dried water extract.

The tests are performed in the following manner.

a. *Test 1.* Place 0.05 gram of the explosive in a 5 milliliter beaker, add 2 to 3 milliliters of distilled water, and stir for 5 minutes.

(1) Observe color of liquid.

(2) Wet one end of a strip of universal pH indicator paper and note any change in color.

(3) Add a drop of Nessler's reagent and note the color of any precipitate formed. Prepare the reagent by dissolving five grams of potassium iodide in a minimum quantity of cold distilled water and adding a saturated aqueous solution of mercuric iodide until a faint precipitate is formed. Add 40 milliliters of 50-percent potassium hydroxide solution. After the solution has clarified by settling, dilute to 100 milliliters with distilled water, allow to settle, and decant.

b. *Test 2.* Place 0.05 gram of the unknown material in an indentation of a white porcelain spot-test plate. Add two or three drops of a 65 to 68 percent aqueous solution of ethylenediamine and stir. Note the color of the solution (not the solid).

c. *Test 3.* Place 0.05 gram of the unknown material in an indentation of a white porcelain spot-test plate and add three or four drops of a diphenylamine solution. Stir the mixture and, after one minute, note the color of the solution. Prepare the diphenylamine solution by dissolving one gram of diphenylamine in 100 milliliters of concentrated CP sulfuric acid.

d. *Test 4.* Place 0.05 gram of the unknown material in an indentation of a white porcelain spot-test plate. Add an equal amount of crystalline thymol and three drops of concentrated sulfuric acid. Stir the mixture and note its color after five minutes or more.

e. *Additional Tests.* If the unknown material is not identified completely by the tests in subparagraphs 13-2 a. through d. and data listed in table 13-1, tests should be performed to determine whether the material is one of those indicated in (1) through (14) below.

(1) RDX. Place several milligrams of the white, unknown material in a test tube and add about 200 milligrams of thymol and six drops (0.3 ml) of concentrated sulfuric acid. Warm the tube for five minutes at 100°C, and add 5 to 10 milliliters of ethanol. RDX produces a rich blue color. Under these conditions sugars and aldehydes give a brown color, and HMX

gives a pale blue-green color. RDX can be further distinguished from HMX by repeating the test at 150°C. Under these conditions RDX still gives a blue color, but HMX produces an olive color.

(2) Composition A-3. Place 0.1 gram of the material in a 10 milliliter beaker and add two or three drops of acetone. Warm the mixture and allow to stand for five minutes. Evaporate the acetone by gently warming on a steambath, cool, and add 2 milliliters of carbon tetrachloride. Cover the beaker and warm the contents, occasionally swirling the mixture. Cool the mixture and allow the undissolved material to settle. Decant the supernatant liquid into a 5 milliliter beaker, evaporate to dryness, and note if a waxy (not tarry) residue is obtained. Dry the undissolved material in the 10 milliliter beaker and test for RDX as described in (1) above.

(3) Composition B. Place 0.2 gram of the pale yellow to medium brown material in a 10 milliliter beaker and add 2 to 3 milliliters of chloroform. Cover the beaker. Warm and digest the mixture for 10 minutes with occasional swirling. Decant the supernatant liquid through a filter paper and evaporate the filtrate to dryness. Repeat digestion of the insoluble residue in the beaker with three more portions of chloroform discarding the decanted liquid in each case. Dry the insoluble residue by evaporating any adherent chloroform. If the original material was composition B, the residue from the chloroform solution consists of TNT and wax. Test the TNT and wax mixture with ethylenediamine and diphenylamine as described above. The insoluble residue obtained by extraction with chloroform consists of RDX. Test as described in (1) above.

(4) Composition C-3. Place 0.2 gram of the putty-like explosive in a 10 milliliter beaker and add 5 milliliters of benzene. Mix and digest for 10 minutes crushing any lumps present. Decant the supernatant liquid through a filter paper and evaporate the benzene with gentle heating. Note whether a dark, tarry residue remains. Wash the insoluble residue left by benzene extraction with two or three, 3 milliliter portions of a 2: 1 ether-ethanol mixture and dry the washed residue. Test this as described under RDX in (1) above. To the decanted ether-ethanol washings, add 15 milliliters of distilled water and heat the mixture until all ether and alcohol are removed. If a white precipitate (nitrocellulose) is noted, catch the precipitate on a filter, wash with ethanol, dry by evaporation of the ethanol, and test for nitrocellulose as indicated in table 13-1.

(5) Torpex. Place 0.2 gram of the explosive in a five milliliter beaker and extract with three, 3 milliliter portions of acetone. Dry the insoluble residue and examine under a microscope. Note if the residue has the characteristic appearance of metallic aluminum. Place 0.2 gram of the explosive in a 5 milliliter beaker and digest with two, 3 milliliter portions of benzene, decanting the benzene into a small evaporating dish. Evaporate the benzene solution to dryness and test for TNT as indicated in table 13-1. Dry the insoluble residue from the benzene extraction and test for RDX as described in (1) above.

(6) Tritonal. Place 0.2 gram of the explosive in a 10 milliliter beaker and add 5 milliliters of acetone. Stir, allow any undissolved material to settle, and decant the liquid. Wash the insoluble matter with two, 5 milliliter portions of acetone, dry, and examine under a microscope. Note if the insoluble matter has the characteristic appearance of metallic aluminum. Subject the separated explosive to the tests prescribed for TNT in table 13-1.

(7) Amatol. Place 0.2 gram of the yellow material in a 5 milliliter beaker, add 3 milliliters of distilled water, and stir for five minutes. Decant the liquid through a filter and evaporate to dryness. Test the dried solid as prescribed for ammonium nitrate in table 13-1. Dry the water-insoluble residue and test as prescribed for TNT above.

(8) Ammonal. Place 0.2 gram of the explosive in a 10 milliliter beaker and digest with 3 milliliters of distilled water. Decant the liquid through a filter and evaporate to dryness. Test the dried solid as prescribed for ammonium nitrate. Digest the insoluble residue in the beaker with three, 3 milliliter portions of acetone decanting these through a filter. Dry the insoluble residue and examine under a microscope. Note if the residue has the characteristic appearance of metallic aluminum. Evaporate the filtrate to dryness by warming gently. Test the dried solid as prescribed for TNT above.

(9) Lead azide.

(a) Test the explosive for solubility in water. Lead azide is insoluble in water.

(b) Transfer 5 milligrams of the sample explosive to a 100-milliliter beaker and add 10 drops of a 10-percent ceric ammonium nitrate solution. A reaction accompanied by evolution of nitrogen oxides (red fumes) is indicative of the presence of azide.

(c) Treat the solution of the sample obtained in (b) above with a few drops of a 10 percent aqueous solution of potassium dichromate. A yellow to reddishyellow precipitate is indicative of the presence of lead.

(d) Transfer 2 milligrams of the sample to a 5 milliliter beaker. Add 5 milliliters of a 10 percent aqueous solution of ferric chloride solution. A red color is formed which disappears slowly when 2 to 3 milliliters of dilute mercuric chloride solution are added. This confirms that the explosive is lead azide.

(10) Mercury fulminate.

(a) Test the explosive for solubility in water. Mercury fulminate is insoluble in water.

(b) Transfer 10 milligrams of the sample explosive to a fritted glass crucible of medium porosity. Extract the sample with a 20 percent aqueous solution of sodium thiosulfate, catching the washings in a 50-milliliter beaker containing 10 drops of a one percent phenolphthalein indicator solution. When the mercury fulminate is treated with sodium thiosulfate, it dissolves with formation of alkali (NaOH) which changes the color of the indicator solution from colorless to red.

(c) Transfer 10 milligrams of the sample to a 100-milliliter beaker and add three drops of concentrated hydrochloric acid solution and 2 milliliters of water. Transfer the solution to another beaker containing one drop of a five percent aqueous solution of potassium iodide. The formation of a bright red precipitate indicates the presence of the mercuric ion.

(11) Diazodinitrophenol (DDNP). Dissolve 0.05 gram of the greenish-yellow to brown explosive in acetone. Upon adding a larger volume of ice water, the explosive should appear as bright yellow crystals. Prepare a saturated solution of the explosive in 200 milliliters of water. Add to this 5 milliliters of a 20 percent solution of sodium hydroxide and mix. The evolution of a colorless gas and the appearance of a reddish-brown color in the solution indicate the explosive to be diazodinitrophenol.

(12) Lead styphnate. Wet 0.1 gram of the heavy, light orange to reddish-brown material with 10 milliliters of water and then add slowly 10 milliliters of a 20 percent solution of ammonium acetate. Agitate the mixture until solution is complete. Add 10 milliliters of a 10 percent aqueous solution of potassium dichromate. The appearance of a bright yellow precipitate indicates the presence of lead. To 0.1 gram of the explosive in a beaker add 10 milliliters of a 10 percent solution of hydrochloric acid. Heat the mixture in a steambath and evaporate to dryness. Cool the beaker and contents and add 10 milliliters of ether. Mix the contents and allow to settle. Decant or filter off the yellow ether solution and evaporate this to dryness at ordinary temperature. Dissolve the residue in 25 milliliters of water and add 0.1 gram of solid potassium cyanide. The absence of color indicates the explosive to be lead styphnate.

(13) Tetracene. Wet 0.25 gram of the fluffy, pale yellow explosive with 5 milliliters of a 10 percent solution of sodium hydroxide and warm the mixture in a steambath until solution is complete. Note if there is an odor of ammonia. Cool the solution and add 1 milliliter of a five percent solution of copper acetate. The appearance of a bright blue precipitate indicates the explosive is tetracene.

(14) Black powder. Place 0.2 gram of the black material in a 5 milliliter beaker, add 2 to 3 milliliters of distilled water, and stir for five minutes. Decant the liquid through a filter and catch the filtrate in a beaker. Evaporate this to dryness and subject the dried white solid to the tests shown in table 13-1. Dry the water-insoluble residue in the beaker, cool, and digest with two 5 milliliter portions of carbon disulfide, decanting these into an evaporating dish. Evaporate the carbon disulfide solution to dryness at room temperature. By means of a microscope, examine the yellow residue so obtained and the insoluble black residue from the carbon disulfide extraction. Note if they have the characteristic appearances of sulfur crystals and charcoal, respectively.

13-3. Chromatography.

a. *Column Liquid Chromatography.* This is the oldest form of chromatography and is sometimes called column chromatography. The equipment consists of a vertical glass or quartz column which is constricted at the lower end. The column is filled with a fine, granulated material which is most commonly silica gel but may be metal oxides (alumina), sugars, etc. This is called the stationary phase. A chemical mixture in a suitable solvent is placed in the top of the column and allowed to diffuse downward. The solvent is called the mobile phase. Vacuum is sometimes applied to the bottom of the column. The chemical components of the mixture will diffuse at different rates due to their difference in affinity for the column material. After sufficient time the components will be separated into bands along the length of the column. If the components are colored, the bands can be easily detected. Colorless or white component bands can be detected by adding a fluorescent material to the column material contained in a quartz column and irradiating with ultraviolet light. The column is then extruded from the tube and cut into bands. The separated compounds in the bands are eluted by suitable solvents and subjected to quantitative and qualitative analyses procedures. The solvent has a significant effect on the interaction between the material under test and the column material. Therefore, the proper combination of column material and solvent must be used for

each material under test. Column liquid chromatography has been implemented by other modern chromatographic techniques because the procedures are time consuming and tedious.

b. *Paper Chromatography.* In paper chromatography both the stationary and mobile phase are liquids. The stationary phase liquid, which is usually water, is supported on a filter paper. A spot of the mixture to be tested is placed on the filter paper. The spot is then dried. The filter paper is then placed in a trough which contains the mobile phase. The liquid mobile phase is immiscible with the liquid of the stationary phase. The mobile phase is usually a mixture of organic solvents. The eluent is allowed to migrate either upward or downward on the paper. As the eluent migrates, the compounds in the mixture separate, each traveling with the eluent but at a different rate. After the eluent front has advanced between 15 and 30 centimeters the paper is removed from the trough and dried. A color reagent is sprayed on the paper to locate all the separated compounds. The ratio of the distance traveled by the separated compound to the distance traveled by the eluent front is then computed. In some cases the filter paper is impregnated with hydrophobic substances such as oils or paraffins and the mobile phase is aqueous. This is called reverse phase paper chromatography. Most work with energetic material has been done using the reverse phase technique. Paper chromatography is not generally used for identification of energetic material as is thin layer chromatography.

c. *Thin Layer Chromatography.* A thin layer chromatographic plate consists of a thin layer of powdered material mixed with a binder that is applied to a smooth surface such as a glass, aluminum, or plastic sheet. The powdered material, which constitutes the stationary phase, usually consists of silica gel or aluminum oxide of uniform particle size. A solution of the mixture to be tested is spotted near the bottom of the plate. The plate is then placed vertically in a trough of solvents, called the developing solvents, contained in a closed developing tank. The level of the developing solvent in the trough is below the spot of test material. The developing solvents constitute the mobile phase. The mobile phase is drawn up into the stationary phase by capillary action. As the level of the mobile phase rises, the compounds of the test mixture are separated, each traveling with the mobile phase but at different rates. The liquid phase is allowed to rise to the desired level, usually near the top, and the plate is removed from the trough and dried. Colorless spots are detected by either spraying with a color reagent or incorporating a fluorescent material in the chromatographic plate such

that exposure to ultraviolet light will cause luminescence except where spots of ultraviolet absorbing compounds are present. The rate of flow is defined as the ratio of the distance traveled by the compound to the distance traveled by the developing solvent. The rate of flow is affected by many factors such as the plate material, the developing solvent used, plate thickness, dryness of the plate, temperature, and others. Therefore compound identification is made by running the test solution on the same plate as known compounds, not by comparing the rate of flow to published data. When more than one elution is required, thin layer chromatography can be run in two dimensions. The plate is spotted near one of the corners at the bottom. Then the plate is developed normally in a developing solvent that separates the mixture into groups rather than single compounds. The plate is then dried, rotated 90° so that the separated groups are along the bottom, and placed in a second solvent trough. The second solvent separates the groups into single compounds. Thin layer chromatography is used extensively as a qualitative analysis technique. The developing solvents and plate material used vary according to the test material so no single combination of solvent and material can be used for separating all the energetic materials.

d. *Gas Chromatography.* In gas chromatography the vapor of the material to be tested is injected into a stream of inert gas such as nitrogen, and passed through a column. The carrier gas is the mobile phase, the material in the column is the stationary phase. The stationary phase can be either a solid or a liquid supported on a solid. If the stationary phase is solid the method is called gas-solid chromatography (GSC). If the stationary phase is a liquid supported on a solid then the method is called gas-liquid chromatography (GLC). Two types of columns are used in GLC; packed columns, which contain an inert nonvolatile liquid, and capillary columns, which are long, open tubes of small diameter that have a thin, liquid film on their inner surface. Capillary columns offer a greater resolution of mixture. As the carrier gas flows through the column the components of the test mixture separate, each traveling through the column material at a different rate. A detector at the end of the column detects when the gas being tested emerges. Three types of detectors are commonly used; thermal conductivity, flame ionization, and electron capture. A thermal conductivity detector detects changes in the thermal conductivity of the carrier gas. This type detector is simple and nondestructive but the sensitivity is low and the test results are highly dependent on gas temperature and rate of flow. A flame

ionization detector measures the electrical conductivity of the product gases when the carrier and test sample are decomposed in an air/hydrogen flame. This type detector is destructive but more sensitive and does not have a great dependence on the gas temperature. The current carried across the product gas is proportional to the number of carbon atoms but inversely proportional to the number of oxygen and nitrogen atoms. This is the most commonly used detector. An electron capture detector uses a radioactive beta emitter to ionize the carrier gas. An electron capturing compound will remove some of the ions. The resulting decrease in the current carrying capability of the gas indicates the presence of one of these compounds. This method of detection is very sensitive to electronegative compounds, but is insensitive to compounds such as hydrocarbons which do not capture electrons. The detector output is recorded as a function of time, as shown in figure 13-1. Each peak corresponds to a compound in the mixture. There is a general correlation between the area under the peak and the content of the compound in the mixture. However, the area ratio for two compounds does not necessarily represent their weight ratio in the sample. This could be due to several reasons: difference in the detector response for different compounds, adsorption or decomposition of a compound before detection, or a faulty sampling technique. Therefore, to use the recorder output quantitatively a specific amount of a known compound is added to the sample. The sample must react similarly in the gas chromatographic unit to the unknown. Relative weight percentages can then be computed by comparing the area under the curve for the unknown and known sample. Gas chromatography is used for energetic materials, however, in some cases, application of this method is limited by the high temperature at which the test must be run. Nitroaromatics are generally stable at their boiling point, but nitramines and aliphatic nitrated esters are not. For the unstable compounds several techniques are recommended to reduce decomposition; glass rather than metal columns, short column length, lower temperatures, low polarity liquid in the GLC stationary phase, and low loading percentage of the liquid. These precautions also minimize reaction between the compounds in the column. This is a consideration when analyzing the stabilizer content of propellants as the higher temperature tends to drive off nitrogen oxides from the aliphatic nitrated ester and nitrate the stabilizer. Gas chromatography can be run isothermally or with a programmed temperature change.

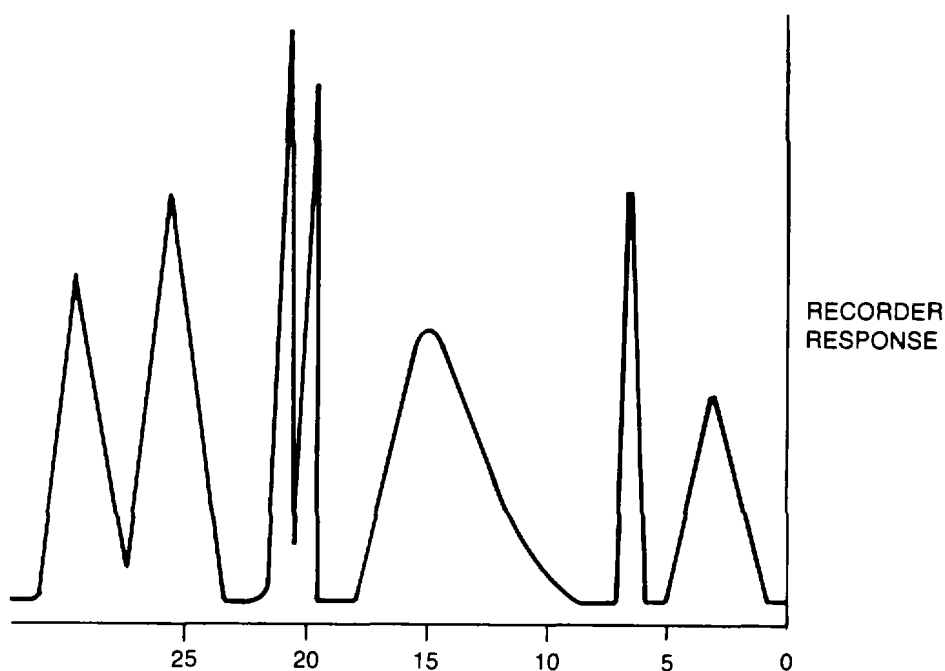

Figure 13-1. Gas chromatograph output.

e. *High Performance Liquid Chromatography (HPLC)*. HPLC is also known as high speed or high pressure liquid chromatography. Separation is done in a glass or stainless steel column that is packed with a fine powdered material, usually silica. Column dimensions are usually 15 to 30 centimeters in length and three to four millimeters in diameter. The packing material, or stationary phase, consists of particles in the 5 to 10 micrometer diameter range. A solvent, the mobile phase, is pumped through the column under pressure in the range of 1,379 to 6,895 kilopascals (200 to 1,000 pounds per square inch). The test mixture to be separated is injected. Separation in the column is accomplished in the same manner as in the other forms of chromatography: the various constituents diffuse down the column at different rates. The composition of the mobile phase can be held constant (isocratic elution) or varied (gradient elution) during the procedure to improve separation. When the column material is silica, surface adsorption is the mechanism of separation. When the silica is coated with a liquid, partition between the two liquid phases is the separation mechanism. The liquids of the stationary and mobile phase must be immiscible. Normal HPLC is performed with a polar stationary phase and a somewhat nonpolar mobile phase. Reverse phase HPLC is performed with a non-

polar stationary phase and polar mobile phase. Another column material is the chemically bonded stationary phase. Silica contains free hydroxyl groups. The hydrogen can be replaced by organic compounds, although direct replacement with a carbon bond is less stable than bonding the oxygen to another silicon which is bound to the organic compound. As the mobile phase emerges from the column an ultraviolet spectrophotometer is used to detect the test material in the eluent. The detector output is plotted as a function of time. The graph obtained is very similar to the one shown in figure 13-1. The area under the peaks in the curve is proportional to the concentration of each component in the test material. A tentative identification of the compounds in the mixture can be made by comparing the graph of the output of the unknown to the graph for known compounds run under the same conditions. This identification, however, is not as specific as other methods and cannot be used in forensic work, for example, where an exact identification is required. The separated compounds can be collected and analyzed individually using one or a combination of other methods for positive identification such as mass spectrometry, infrared spectrometry, and nuclear magnetic resonance.

f. *Ion Chromatography.* Ion chromatography is instrumentally very similar to HPLC, the difference between the methods being the column material. Ion chromatography uses an ion exchange resin stationary phase which can be applied to glass microbeads for packing. While HPLC is based on absorption and partition phenomena, ion chromatography is based on the exchange of ions between the resin and the mobile phase. It is a very good technique for separating cations and anions from each other.

13-4. Polarography. Polarography measures current in microamperes, generated through the reduction/oxidation of chemical species in an electrolytic solution at an applied potential specific to the specie. A reference electrode and polarizable electrode are used. The polarizable electrode normally used is the Dropping Mercury Electrode (DME) which consists of a glass capillary filled with mercury. The mercury is allowed to drip from the capillary at a controlled rate. As a droplet forms at the end of the tube the surface area of mercury exposed to the solution increases. This causes an increase in the current conducted through the solution at any given voltage. There is a sharp decrease in the current when the drop falls. The current then increases during the formation of the next drop. Several forms of polarography are used: DC, single sweep, AC, and differential pulse. These four forms differ only in the manner in which voltage is applied between the electrodes. In DC polarography, a DC potential, which is increasing linearly at the rate of 1 to 10 millivolts per second, is applied between the electrodes. At low voltages a small current, called the residual current, flows. This current is due to charging the capacitance between the DME and the solution and miscellaneous impurities in solution. At a critical voltage depending on the chemical specie the current begins to increase with increasing voltage. The current continues to increase until a maximum current is attained, at which point further increases in voltage do not increase the current. The plot of the applied voltage versus the current is called a polarogram. The difference between the residual current and maximum current is called the diffusion current. The diffusion current is proportional to the concentration of the chemical specie. In single sweep polarography, a DC potential increasing at the rate of 100 to 500 millivolts is applied between the electrodes. The voltage is applied at a specific time during the formation of the mercury drop. The applied

voltage is plotted against the current to obtain a polarogram. Single sweep polarography is more accurate than DC polarography because the shorter time frame in which the measurement is made allows less change in the surface area of the mercury drop. In AC polarography, a small AC signal is placed on the DC waveform used in DC polarography. The effects of the DC potential are electronically removed and a polarogram with peaks in the waveform is obtained. In differential pulse polarography, a pulse is applied just as the mercury drop attains maximum size. The pulse has an amplitude of 5 to 100 millivolts and a width of 50 to 60 milliseconds. The current is measured twice, just before the pulse and during the last 10 to 20 milliseconds of the pulse. The type and concentration of species present is made by comparing polarograms. Polarography is a very sensitive method of detection. Applications include pollution control and analysis of sensitive material such as primary explosives, in which sample sizes are held to a minimum because of safety considerations.

13-5. Spectroscopy and Spectrometry.

a. *Ultraviolet and Visible Spectroscopy.* In ultraviolet and visible spectroscopic techniques, a solution of the sample to be analyzed is irradiated with discrete frequencies from the entire range of either the ultraviolet or visible spectrum. To obtain a spectrum of the component, the absorbance, which is defined as the log of quotient of the intensity of the incident and transmitted radiation, is measured and plotted as a function of the frequency of the incident radiation. Usually a blank sample, which consists of only the solvent, is run at the same time so the absorbance of the solvent can be subtracted from the total absorbance of the solution. Ultraviolet and visible spectra are not generally used to identify energetic materials because they are not distinctive. However, the methods may be used for quantitative analysis. The concentration of the compound in solution is determined by measuring the absorbance of the material under test and comparing the value obtained to the value obtained for a solution of the same compound with a known concentration. The same solvent, temperature, and optical path length through the solution must be used. With a limited number of exceptions, the concentration is a linear function of the absorbance.

b. *Infrared Spectroscopy.* Infrared spectroscopy is one of the most widely used methods of identification. The technique can be used with gases, solids, or liquids. Gases or liquids are contained in cells containing salt windows, such as sodium chloride or potassium bromide, that are transparent to infrared radiation over a certain wavelength range. Solids may be in solution in which case a blank cell that contains only the solvent is tested in tandem with the material under test to compensate for the effects of the solvent. Solids may also be prepared for testing by grinding with mineral oil and placing between two sodium chloride plates or grinding with potassium bromide and pressing into a pellet. The mineral oil interferes with the spectra over a small wavelength range, but the potassium bromide does not. In the identification of an explosive ingredient, the spectrum of the unknown is examined

and classified in terms of groups present in the molecule (OH; NH; C=O; N-NO₂; aromatic NO₂; C-O-C; C-O-NO₂; etc.) and then compared with the standard spectra that contain the same groups. Table 13-2, which gives spectral correlations of aromatic nitro compounds, nitramines, and nitrates, is useful for this purpose. Using infrared spectroscopy for identification depends on having a library of spectra for comparison to the spectra of unknowns. The spectra can be digitized and a computer used to search rapidly among known spectrum. Usually the programs do not identify the compound completely, but narrow the possibilities to about 10 compounds. Infrared spectroscopy is most effective when the sample is a pure compound, so separation techniques such as solvent extraction or chromatography may be used on a sample before irradiation.

Table 13-2. Spectral Correlations of Aromatic Nitro Compounds, Nitramines, and Nitrates

Structure	Band assignments, μm	Comments
<i>sym</i> -trinitro	9.25	Found in all <i>sym</i> -trinitro compounds examined which have the following additional groups: OC ₂ H ₅ , CH ₃ , OH, C ₂ H ₅ , COOH, OCH ₃ , NH ₂ . The band appears to shift to about 9.35 μm in the presence of acidic groups such as COOH or OH.
<i>m</i> -dinitro	10.85-10.95	Found in all <i>m</i> -dinitro compounds examined which have contained the following additional groups: CH ₃ , C ₂ H ₅ , OH, N=NH ₂ , COOH, CHO, OCH ₃ , CH ₃ NH, C ₂ H ₅ NH, NO ₂ (trinitro). In the trinitro compounds the position of the band has been found from 10.75 to 11.0 μm .
	11.90-12.05	Found in <i>m</i> -dinitro compounds examined where other additional groups, if any, were ortho to the nitro. Not found in <i>sym</i> -trinitro compounds but present in 2,3,4- and 2,4,5-trinitrotoluene. Absent in 3,5-dinitrobenzoic acid and 4,6-dinitro- <i>o</i> -cresol. It appears that a group meta to the nitro inhibits the band.
<i>o</i> -mononitro	12.7-12.8	Found in all mononitro compounds containing any one of the following groups ortho to the nitro: CH ₃ , C ₂ H ₅ , CHO, NH ₂ , COOH. Not usually found in dinitro or trinitro compounds.
<i>p</i> -mononitro	9.0	Found in all mononitro compounds containing any one of the following groups ortho to the nitro: CH ₃ , C ₂ H ₅ , CHO, NH ₂ , COOH. Not usually found in dinitro or trinitro compounds.
nitramines	7.8	Found in all nitramines examined. Presumed to be caused by the N-N vibration.
nitrates	6.0	Found in all organic nitrates examined. From the analysis made of methyl nitrate it is presumed that this band is caused by the symmetrical stretching vibration of the NO ₂ .
	7.8	Found in all organic nitrates examined. From the analysis made of methyl nitrate it is presumed that this band is caused by the symmetrical deformation vibration of the NO ₂ .
	12.0	Found in all organic and inorganic nitrates.

c. *Magnetic Resonance.* Two forms of magnetic resonance are used; nuclear magnetic resonance and electron spin resonance.

(1) Nuclear Magnetic Resonance (NMR). When a charged particle spins, a magnetic field or dipole is produced in a manner analogous to the magnetic field produced by current flowing in a loop of wire. An external magnetic field aligns the dipoles, either with the field or 180 degrees out of phase with the field. The out of phase position, in which the north and south poles are reversed, is referred to as against the field. Alignment with the field is more stable than alignment against the field so the application of suitable frequency electromagnetic radiation will cause the dipoles which are against the field to flip into alignment with the field. The frequency at which this occurs is called the resonant frequency. Any nucleus which has a net spin can flip, but the hydrogen nucleus is the most commonly used in NMR. The hydrogen nucleus consists of a single proton, so this method is referred to as proton magnetic resonance. The frequency at which resonance occurs depends on the nucleus and the surrounding medium. The magnetic field that is used to align the protons also changes the configurations of the electrons around the nucleus in such a way that they produce a magnetic field in the opposite direction of the externally applied field. This field shields the nucleus and must be overcome before any of the protons can be flipped. The strength of the field depends on the structure of the electrons around the nucleus. If the atom is bound into a compound and valence electrons are missing, added, or being shared, the effectiveness of the shielding is changed. This alters the resonant frequency for a given magnetic field strength or alters the magnetic field strength required to flip the protons at a given frequency. Either method of scanning, varying the magnetic field strength at fixed frequency or varying the frequency at fixed magnetic field strength, can produce an NMR spectrum. In an NMR spectrum, the resonance of tetramethylsilane (TMS) is taken as the standard and defined as zero. All twelve of the protons (hydrogen atom nuclei) in the methyl groups are in the same chemical state, so the spectra of TMS consists of one very sharp peak. The resonance peaks in the spectra of other compounds are defined in units of chemical shift, ppm's. The chemical shift of a resonant peak is the frequency of resonance of TMS divided by the spectrometer frequency in megahertz at which the analysis is being performed. Dipoles in close proximity can cause peaks to split into doublets, triplets, etc. The difference between the lines of the multiplet in cycles

per second is defined as the coupling constant, J. The value of J yields useful information concerning the positions of the protons in the molecule. The area under the spectra peak is proportional to the number of hydrogen nuclei in a given state. Chemical shift, J, and the area under the peaks provide useful analytical information. Multiple peaks in the spectrum on a single compound are caused by hydrogen nuclei which are in different states. The spectrum of PETN shows one sharp peak because all the protons are in the same chemical state. TNT, however, shows two peaks, one due to the protons in the methyl group and one due to the protons in the ring. The solvent has a considerable effect on the NMR spectrum of a sample, so standard procedures must be used. An exchange takes place between the deuteriums used in the solvent and the active hydrogens in the material under test. This can cause changes in the spectrum: line shifts, intensity shifts, and the creation of new multiplet lines. Stabilized spectra are obtained after the solution has been given enough time to come to equilibrium. This is called the development time. Careful attention must be paid to ensure that the proper development time specified in the specific procedure is used. NMR spectra of unknown compounds can be compared to those of known compounds for identification purposes, or identification can be made on the basis of the analytical information obtained.

(2) Electron Spin Resonance (ESR). This test is sometimes referred to as electron paramagnetic resonance (EPR). ESR can only be performed on samples which contain unpaired electrons. An electron has an intrinsic spin which creates a magnetic dipole along the axis of rotation. In an external magnetic field, the dipoles will align either with or against the field. By applying high frequency energy at right angles to the aligning magnetic field, the magnetic moment, and thus the direction of the electron spin, can be reversed or flipped. Alignment with the field is the preferred direction. Flipping occurs when the frequency of the incident energy is equal to the frequency of precession of the electrons. Flipping does not occur in paired electrons because the opposite spin quantum state is already occupied. Scanning is done by either varying the magnetic field strength at fixed frequency or varying the frequency at fixed magnetic field strength. The former method is preferred. ESR, while of limited applicability to the energetic material field, can be used to identify paramagnetic compounds, transition metal ions, and free radicals of organic compounds. Free radical detection has been used in pyrolysis studies.

d. *Mass Spectrometry (MS)*. In mass spectrometry, molecules of the sample to be analyzed are ionized. These ions are then accelerated by an electromagnetic field. The acceleration acquired by each ion in a field of given strength will depend on the fragment's mass and charge. Most of the ions will have a charge of plus one electron unit so separation is on the basis of mass; the more massive of the ions are accelerated less than the fragments having less mass. Two types of electromagnetic fields are generally used for separation: the magnetic selector and the quadrupole. In the magnetic selector, a stream of ions is accelerated to a potential at several kilovolts and introduced into a magnetic field. The direction of the stream is at a right angle to the direction of the field. The magnetic field deflects the path of the ions into a semicircle. The radius of the semicircular path for any fragment for a given magnetic field strength is proportional to the initial or tangential velocity and inversely proportional to the magnetic field strength. A detector is placed at a point in a chosen semicircular trajectory that the ion fragments can travel. For a given initial accelerating potential and magnetic field strength, fragments of a particular mass to charge ratio will strike the detector. The spectra, plotted as a function of the mass to charge ratio, is obtained by scanning the magnetic field strength or the initial accelerating voltage. The former technique is the preferred method in low resolution mass spectrometry. High resolution mass spectrometers use both methods simultaneously to improve separation. In the quadrupole the field produced by a combination of DC and radio frequency power applied to four parallel rods is used to focus the ion fragments rather than a magnetic field. A quadrupole unit is less sensitive than a magnetic selection unit. The ions can be produced by several methods. In electron impact mass spectrometry, the sample is bombarded by electrons boiled off a hot filament. When the sample is ionized in this way organic molecules break up into fragments of various masses. The spectra obtained can be compared with a spectral library to identify unknown compounds, or analytical information from the spectra can be used to identify groups within a molecule. Electron impact of organic compounds produces many products from bond cleavage fragments to complex fragments which have undergone significant rearrangement. In chemical ionization mass spectrometry, the sample reacts with an ionizing compound to produce a positive ion. The ionizing compounds are produced by electron impact of

ammonia, hydrogen, isobutane, methane, or water. The ionizing compounds produce positively charged molecules. The molecules do not fragment as much as in electron impact mass spectrometry. In negative ion mass spectrometry, electrons are absorbed by the sample molecules. Absorption may be accompanied by decomposition of the molecule into charged ions. Field ionization and field desorption mass spectrometry use high voltage electrostatic fields to produce ions. In field ionization mass spectrometry the sample in gas form is passed over a point or edge on which a potential of 107 or 108 volts per centimeter is maintained. Quantum tunneling by electrons in the gas to the high potential forms ions. In field desorption the sample molecules are absorbed, or deposited, on a surface. A strong electromagnetic field is applied to desorb the molecules as ions.

13-6. Detection and Identification of Residues.

a. Detecting and collecting the residue of explosives left after detonation is a difficult task. Detonation is a relatively complete reaction and the small amount of explosive left is scattered over a large area. The general destruction of the area also hampers the collection effort. The most likely places for the residue to be found is in the soil and other debris in the blast seat; wood, plastic, and other materials which can catch and hold the flying residue particles; and metal objects which were close to the point of detonation such as a part of the bomb. The debris from the explosion site is first microscopically examined. Many times black and smokeless powders can be identified by the shape and color of the residue. A vapor trace analyzer can be used on the debris to identify volatile explosives such as nitroglycerin. The vapor trace analyzer consists of a vapor preconcentrator and a gas chromatograph with an electron capture detector. The residue in the post detonation debris is of little chemical integrity. Solvent extraction is used to dissolve the residue for analysis. Solvent selection is important. Extraction of substances that could interfere with the subsequent analysis of the explosive is undesirable. Large amounts of solvent are used to extract even small amounts of explosive residue, so only analytical techniques which can handle trace amounts are used. The methods described in paragraphs 13-2 through 13-5 can be used. In addition X-ray diffraction patterns can be compared to patterns of known compounds for identification. Residues on hands and clothes are extracted and tested similarly.

b. Detection and identification can be made easier by adding a taggant to explosives. One taggant system which has been proposed consists of small layered particles which are laminated to increase the probability of surviving detonation. Each layer can be one of a number of colors. The sequence of colors can be decoded to determine the explosive and manufacturer. Magnetic particles and fluorescent indicators which respond to ultraviolet radiation are added to make the taggant particle easier to find after a detonation. Another taggant system which has been proposed uses layers of magnetic material with different Curie points. The Curie point is the temperature at which ferrimagnetism ceases.

13-7. Detection of Hidden Explosives.

a. Explosives can be detected using a variety of techniques. Many of the methods depend on vapor detection. Two methods, gas chromatography and mass spectrometry, have already been described. Electron capture detectors work on the same principle as the electron capture detector in gas chromatography which is discussed in paragraph 13-3d. In plasma chromatography the vapors are ionized at atmospheric pressure. An electrostatic field is applied to cause the ions to drift. Heavier ions will drift slower than lighter ones due to collisions with the inert gas at atmospheric pressure. In chemiluminescence, the reaction between ozone and NO, which produces luminescence, is used. In bioluminescence, microorganisms that luminesce in

the presence of explosive vapors are used. For improved detection, two microorganisms may be used, one which gets brighter in the presence of the vapor while the other gets dimmer. In laser optoacoustic spectroscopy a modulated laser beam is tuned to the proper frequency to excite the vapors of explosives in a closed cell. The energy of the excited state is changed to translational energy through collisions with surrounding molecules. The translational energy is detected acoustically.

b. Animals, such as dogs, can also be used to detect explosive vapors. Vapor detection can be defeated with hermetic sealing. However, several methods are considered practical for detection of bulk explosives. The nuclear magnetic resonance techniques can be used. X-ray contrast can also be used. In this method gamma rays are passed through the material under test. The attenuation through the material is measured, then analyzed by a computer. Thermal neutron-activation can be used to detect bulk explosives. In this method a thermal neutron is absorbed by a nitrogen-14 nucleus to produce a nitrogen-15 nucleus in an excited state. The nitrogen-15 nucleus will go to ground level by emission of a gamma ray. Neutron-nitrogen reactions can be differentiated from the neutron-other element reactions by the energy of the gamma rays produced. A system to make explosives easier to detect is to add a vapor taggant to the explosive material.

13-11(13-12 blank)

CHAPTER 14 PACKING, MARKING, STORAGE, AND SHIPMENT OF ENERGETIC MATERIALS

14-1. Introduction. The regulations governing the marking, packing, and shipping of military supplies are set forth in applicable Army regulations. These operations will also comply with Department of Transportation regulations. This chapter contains general regulations applying to the marking, packing, and shipping of explosives and ammunition. No live ammunition component that has been subjected to undue or abnormal forces for test purposes shall be offered for surface shipment by commercial carrier or be transported over public transportation systems by government conveyance except:

- a. Items containing small quantities of explosive and constructed or packaged so that their explosive forces will be self-contained if they function.
- b. Explosive items which both the testing agency and the project manager or appropriate major subordinate command agree in writing can be safely transported.

14-2. Packing.

a. *General.* Explosives are packaged to safely meet a wide variety of shipping and storage situations. Storage conditions may vary from the best possible coverage to no cover at all and from extremes in climatic conditions. Figures 14-1 through 14-7 are representative sample of explosives packaging.

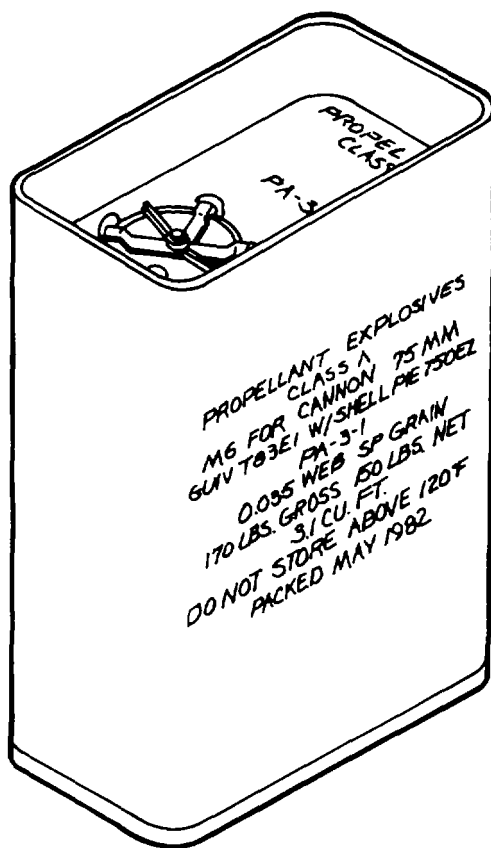

ARR82-0062

Figure 14-1. Steel box for packing solid propellants, including marking.

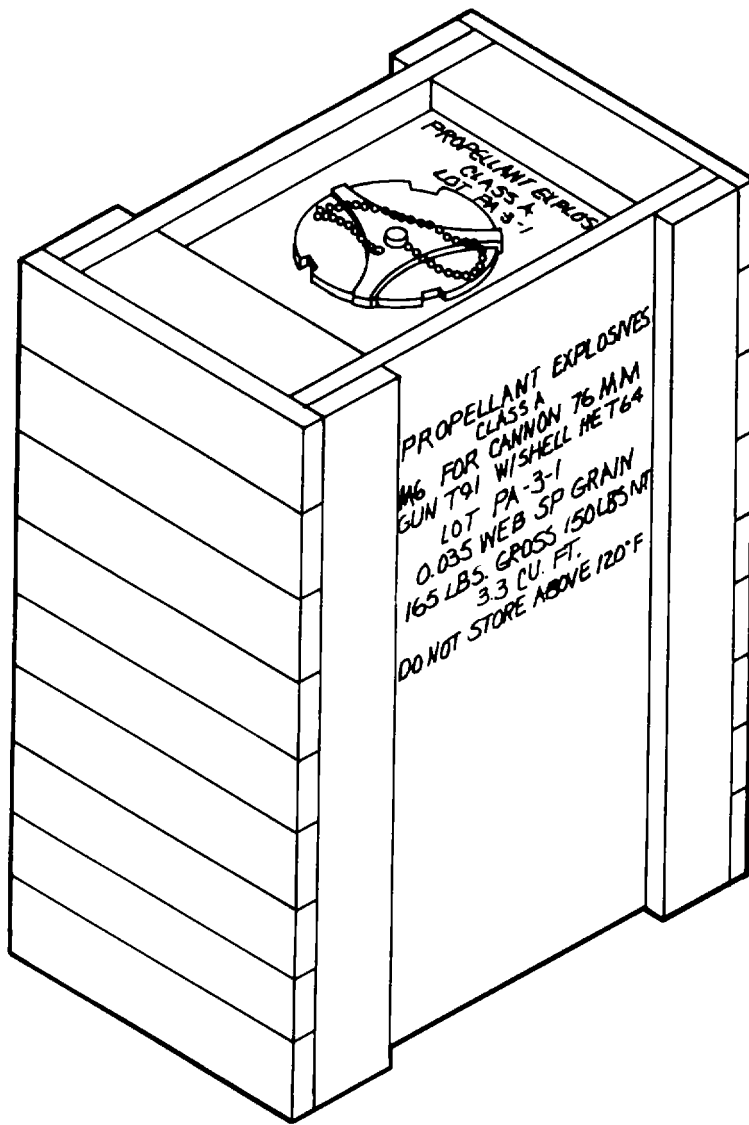

ARR82-0063

Figure 14-2. Metal lined wood box for packing solid propellants, including markings.

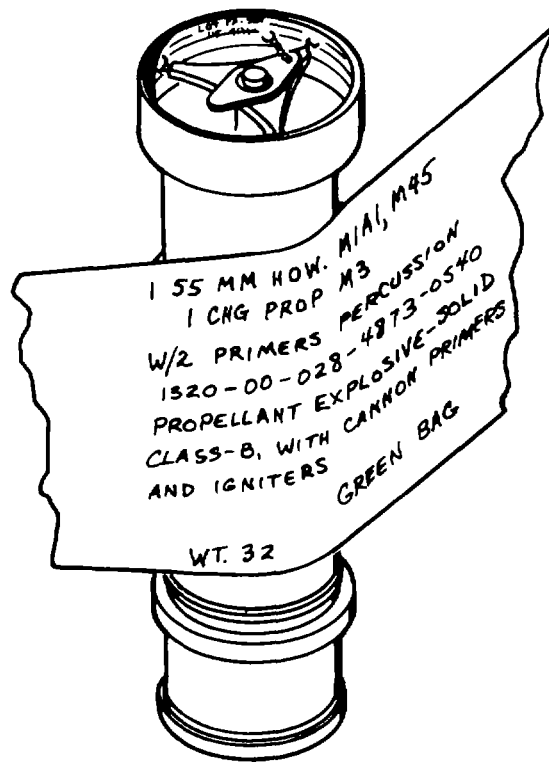
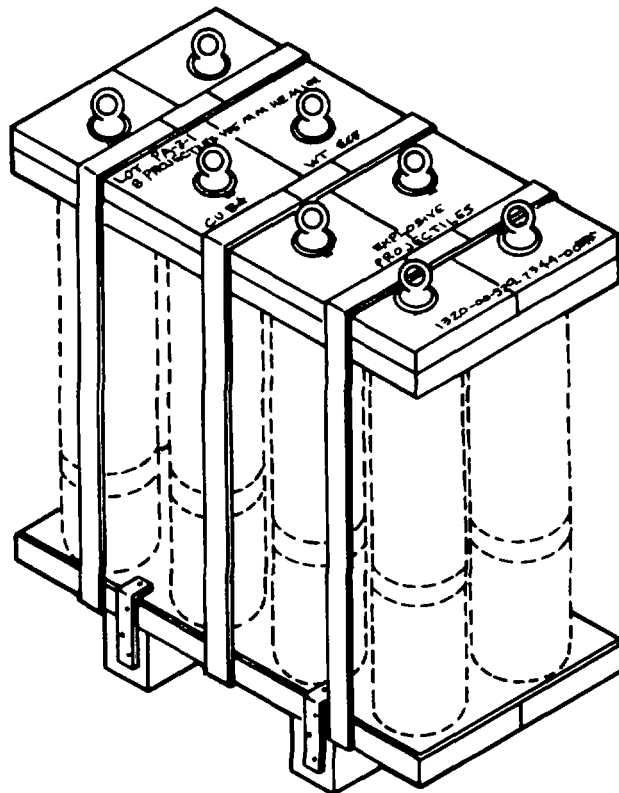
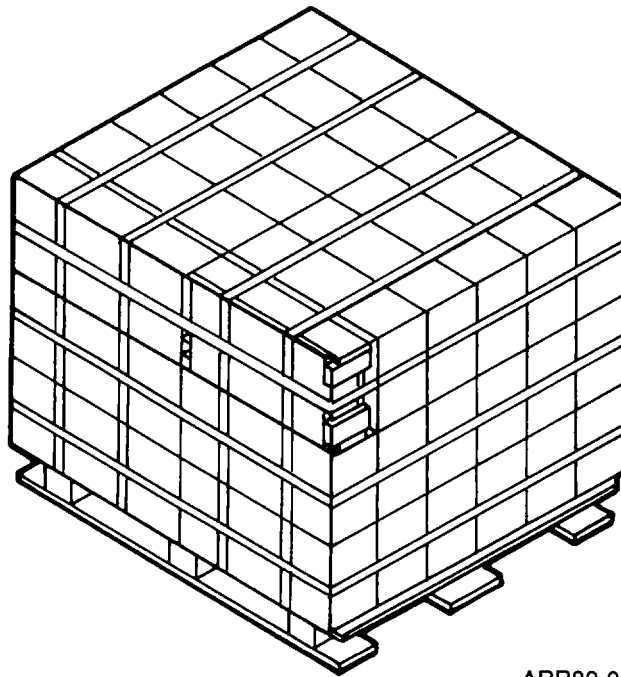

Figure 14-3. Metal containers for propelling charges, including marking.



ARR82-0065

Figure 14-4. Palletized large caliber high explosive projectiles, including marking.



ARR82-0066

Figure 14-5. Palletized wood boxes containing explosives.

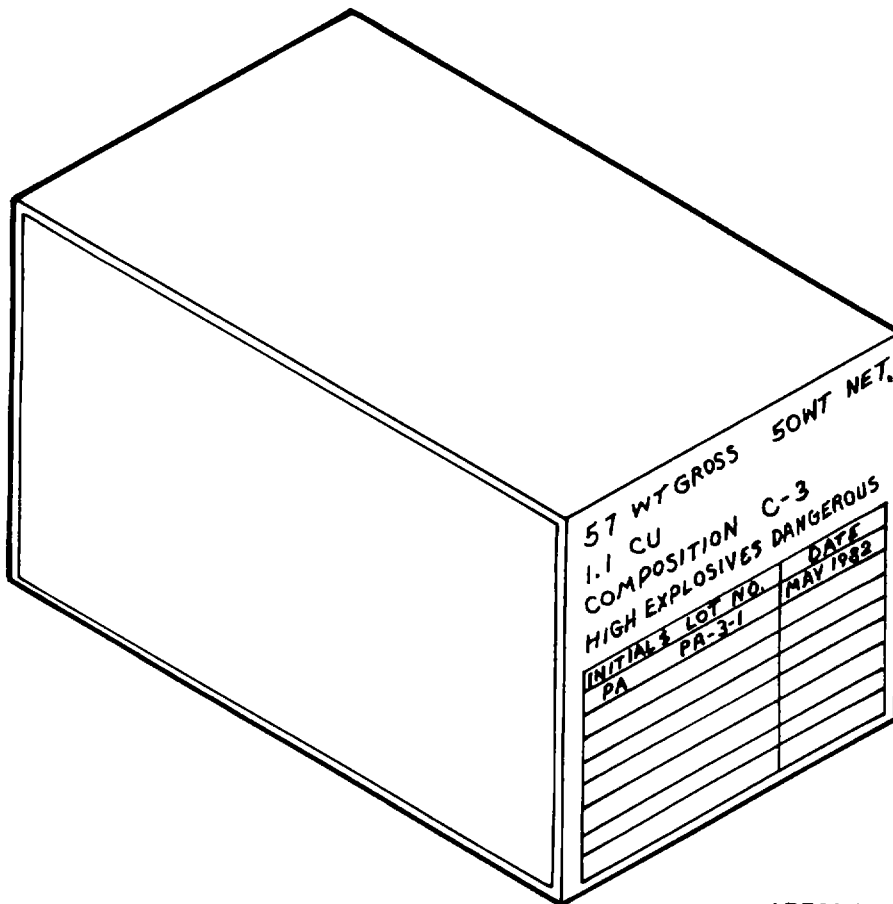

ARR82-0060

Figure 14-6. Carton for packing high explosives, including marking.

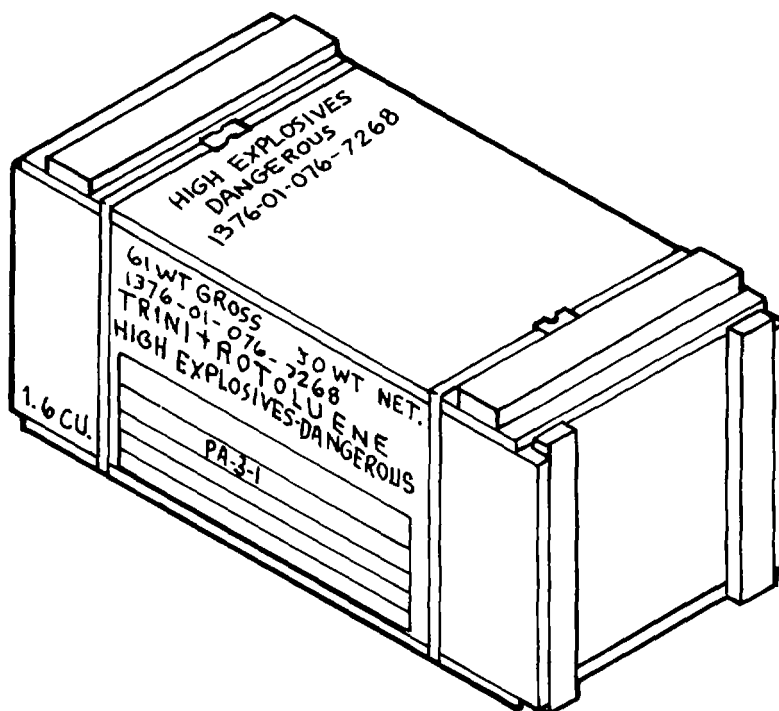

ARR82-0061

Figure 14-7. Wood box for packing high explosives, including marking.

b. Containers.

(1) Hazardous materials in bulk or liquid form must be transported in containers which will prevent leakage. Containers used in intraplant transportation and service storage of explosives and explosives mixtures such as initiating explosives, pyrotechnic compositions, and tracer materials should be made of material in the following order of preference: (a) Conductive rubber.

(b) Nonferrous metal-lined boxes without seams or rivet heads under which explosive dust can accumulate.

(c) Plastics (conductive type only).

(d) Paper-lined wood boxes.

(e) Fiber drums.

(2) Fiber drums or bulk explosives and propellants should be shipped only by motor carrier or trailer-on-flat car. Glass containers should not be used because of their fragility and severe missile hazard.

c. Black Powder Containers.

(1) Standard containers for black powder are built in accordance with drawings that meet DOT specifications.

(2) When black powder is shipped or received each container shall be inspected for holes and weak spots,

particularly holes made by small nails which are visible only upon close examination. Damaged containers must not be repaired; the contents shall be transferred to new or serviceable containers.

(3) Empty black powder containers may be reused and may be transported empty provided they are clean. Empty metal containers which are not to be reused and will be salvaged shall be thoroughly washed inside with water.

(4) Black powder containers must be carefully opened. When it is necessary to open containers by puncturing, the operation will be conducted by remote control.

d. Containers for Solid Propellants.

(1) Solid propellants shall be packed in accordance with approved DARCOM drawings that comply with DOT regulation (fig 14-1).

(2) Double-based solid propellants, single perforated solid propellants, and all solid propellants with web thickness not greater than 0.4826 millimeters (0.019 inch) should not be packed in all-steel boxes. Metal lined wooden boxes (fig 14-2) should be used.

(3) Salvaged or deteriorated solid propellants should be shipped water wet.

e. Containers for Ammunition and Bulk High Explosives.

(1) Ammunition (fig 14-3, 14-4, and 14-5) and bulk high explosives (fig 14-6 and 14-7) shall be packed in accordance with approved DARCOM drawings that comply with DOT regulations.

(2) Containers used for packing bulk high explosives should be lined with strong cloth or paper bags or liners with cemented seams to prevent sifting.

14-3. Marking.

a. Each package of explosives is marked in accordance with pertinent drawings to provide positive identification (NSN, DODAC, nomenclature, lot number, and ICC marking as a minimum).

b. Whenever explosives or ammunition containers or ammunition and ammunition components are repainted, the new painting or marking shall correctly identify contents of items. The marking of empty or inert loaded ammunition items for display purposes is governed by the provisions of AR 385-65.

c. Explosives, ammunition, and loaded ammunition components obtained from salvage operations and material which has lost its identification markings shall be clearly marked to show the explosive nature of the material. Explosive material or items which cannot be definitely identified as to their explosive nature should be disposed of by technically trained personnel in accordance with the provisions of DARCOM-R 385-100.

d. See figures 14-1 through 14-7 for a representative sample of markings required on explosives packaging.

14-4. Storage of Explosives and Ammunition.

a. *General.* The types of existing magazines listed below are considered standard for the storage of the types of items specified. New storage magazines should be of the earth covered, corrugated steel, or reinforced concrete arch type.

b. *Magazines.*

(1) Earth covered magazines. These include igloo, steel arch, Stradley, special type, hillside, and subsurface type magazines. Earth covered magazines are preferred for the storage of all items of ammunition or explosives.

(2) Standard ammunition magazines (commonly called "standard magazines"), classed as above ground magazines. These magazines were designed for the storage of fixed rounds or separate

loading projectiles. For future use, they should be restricted to the storage of Classes (04) 1.2, (08) 1.2, (12) 1.2, 1.3, and 1.4 materials (excluding rockets and rocket motors). The magazines measure 15.7 by 66.6 meters (51 feet 7 inches by 218 feet 8 inches), are usually spaced 91.5 meters (300 feet) apart, and have concrete foundation walls and piers, hollow-tile walls, steel frames, and concrete floors. The storage capacity of the magazines is not stated in definite figures since the number of items which can be stored is regulated by the appropriate quantity-distance tables.

(3) High explosives and black powder magazines, classed as above ground magazines. These magazines were designed for the storage of bulk explosives such as black powder, TNT, tetryl, and explosive D and may be used for this purpose where more desirable storage space cannot be obtained. They are 8.4 meters (27 feet 6 inches) wide and 13.2 meters (43 feet 4 inches) long and are usually spaced 243.8 meters (800 feet) apart. They have concrete foundation walls and piers, hollow tile walls filled with sand, steel frames, and concrete floors covered with sparkproof mastic or the equivalent. The magazines were originally designed for the storage of 1 13,400 kilograms (250,000 pounds) of explosives, but in order to assure adequate aisle space for inspection and shipping and convenient height of piles, the amount of storage is usually limited to approximately 45,360 kilograms (100,000 pounds).

(4) Primer and fuze magazines, classed as above ground magazines. These magazines were designed for storing primers, primer detonators, adapters and boosters, and fuzes of all types. In the future when it is necessary to use magazines of this type, they should be restricted to the storage of Classes (04) 1.2, 1.3 (except rockets and rocket motors), and 1.4 ammunition and explosives. The magazines are 8.4 meters (27 feet 6 inches) wide, 13.2 meters (43 feet 4 inches) long and are usually spaced 91.5 to 121.9 meters (300 to 400 feet) apart. With respect to construction details, they are similar to high explosive and black powder magazines except the hollow tile walls are not sand filled and the floor is not covered with spark proof mastic.

(5) Service magazines and service storage buildings. These buildings are used for intermediate storage of the minimum amount of explosives necessary for safe and efficient manufacturing or processing operations. Construction details of such magazines should specify the use of fire-resistant materials and/or fire-resistive construction.

(6) Other structures. Structures not of approved magazine type shall not be used for the storage of explosives and ammunition except when authorized by the Commander, HQ DARCOM, Attn: DRCSF.

c. *Temperature Control.*

(1) Sudden changes in temperature may damage airtight containers or may result in excessive condensation of moisture. If the temperature in a magazine exceeds 37.80C (100°F) for a period of more than 24 hours, the magazine should be cooled by wetting the exterior of the building with water or by opening the doors and ventilators after sunset and closing them in the morning. If these methods do not prove effective in lowering the temperature, the Commander shall decide whether the materials should be removed to some other magazine.

(2) Storage magazines, in general, should not be provided with heat. Exception is made in the case of magazines where heating may be necessary to prevent condensation of moisture, to maintain constant temperature, or other reasons. If steam or hot water coils are used to heat a magazine, they must be so arranged that explosives material cannot come in contact with the coils. The coils must be kept clean.

d. *Magazine Operational Regulations.* The following regulations shall be complied with where ammunition and explosives are stored:

(1) Instructions as printed on magazine placards, DA Label 85, must be posted on or near each door of the magazine so that they are visible when work is being done in the magazine.

(2) Loose components of ammunition, packing materials, conveyors, skids, dunnage, empty boxes, and other similar material shall not be stored in magazines containing ammunition or explosives.

(3) Vegetation around all ammunition and explosives storage locations shall be controlled.

(4) Doors and locks must be kept in good working order. Magazines shall be locked at all times except when permitted operations are in progress in the magazine and as provided for in paragraph 14-4c(1). A crew must not be permitted to work in a position in a magazine which requires passing the work aisle or position of a second crew to reach an exit. The number of crews shall not exceed the number of exits. Two or more doors must be unlocked and open when personnel work in magazines having more than one door.

(5) Flammable liquids, except when used as the chemical filler of a munition or as a prepackaged

storable liquid propellant, shall not be stored in magazines containing explosives.

(6) Except when required for security purposes, service magazines within an operating line need not be locked during shift operations. These magazines must be locked whenever the operating line is shut down; i.e., nights, weekends, and holidays.

e. *Stacking.*

(1) Ammunition and explosives shall be stored in containers as prescribed by approved DARCOM drawings and specifications and shall be stacked and arranged in a magazine in accordance with instructions set forth in Army regulations and approved DARCOM drawings and directives. Explosives or ammunition in stacks shall be grouped and identified according to lots. When military explosives or ammunition are not packed in accordance with approved drawings and specifications, they must be stored in accordance with special instructions from the Commander DARCOM, ATTN: DRCSF. General rules set forth in paragraphs (2). and (3) below should be followed in the absence of applicable storage drawings.

(2) Methods used for stacking must provide for good ventilation to all parts of the stack. Adequate dunnage shall be used for this purpose.

(3) Aisles shall be maintained so that units in each stack may be inspected, inventoried, and removed for shipment or surveillance tests. Block storage is permitted, provided adequate ventilation of stacks exists. Unobstructed aisles shall be maintained to permit rapid egress of personnel.

(4) Only one light box, pallet, or unit should be allowed per lot in storage. A light box, pallet, or unit is defined as a box, pallet, or unit which contains less than the normal quantity or count. Packaging and marking shall be in accordance with approved drawings and regulations. Light units shall be readily visible and immediately accessible when stacked in storage. Light units might be painted white.

f. *Permitted Open Storage.*

(1) Open storage of ammunition/explosives and limited material will not be used in lieu of covered storage employing standard facilities and/or methods.

(2) When circumstances dictate that open storage must be utilized for storage of Army owned material, the storing installation will submit a request for waiver in accordance with DARCOM-R 385-100. Requests involving material owned by another service will be forwarded through the same channel (through HQ DARCOM, ATTN: DRCSF-E) to the owning service.

(3) Bulk solid propellants, bagged propelling charges, pyrotechnics, bulk high explosives, and critical items shall not be placed in open storage.

g. *Open Storage Sites.*

(1) Sites for open storage shall be separated from magazines, other facilities, and each other in accordance with the requirements of Chapter 12.

(2) The storage sites shall be level, well drained, and free from readily ignitable and flammable materials. The supporting timbers or platform upon which the ammunition is stored shall be well constructed to prevent falling, sagging, and shifting of the ammunition. In order to assure stack stability and free circulation of air, not less than three inches of dunnage should be used between the bottom of the stack and the earth floor. Provisions should also be made for circulation of air through stacks. Non-flammable or fire-resistant, waterproof, overhead covers should be provided for all ammunition containing solid propellants, torpex, tritonal, minol, or chemical agents since each of these materials may be adversely affected by exposure to the elements. An air space of not less than .45 meter (18 inches) should be maintained between the top of the stack and the cover. If adequate ventilation is assured, overhead covers are also desirable for outdoor stacks of bombs and shells. Sides of covered stacks also may be protected by non-flammable or fire-resistant, waterproof covers provided air space is maintained between the cover and the ammunition.

(3) Frequent inspections shall be made to detect sagging piles and accumulations of trash between or under stacks.

(4) If revetments are to be provided around open storage sites, they must comply with the requirements of Chapter 12. Stacks of ammunition must be kept at least 0.61 meter (two feet) from the base of the revetment and at least 0.31 meter (one foot) below the top of the revetment.

(5) Excess dunnage should not be stored between open sites and magazines nor between magazines. Excess dunnage storage sites should comply with applicable quantity-distance requirements except that during open storage operations, service supplies of dunnage may be located not closer than 15.3 meters (50 feet) from the stack being processed.

(6) Suitable types of firefighting equipment and fire symbols should be provided.

h. *Special Requirements for Open Storage.*

(1) *Sites between earth covered magazines.*

Sites may be located midway between adjacent earth covered magazines which are 121.9 meters (400 feet) apart, provided the sites are barricaded and are separated from the barricaded sides of the nearest magazine by 56.4 meters (185 feet). Ammunition in such sites should not be stored beyond lines drawn through the fronts and backs of magazines in the same row. Barricading does not reduce the required inhabited building or public traffic route distances. The storage of Class 1.2 between earth covered magazines is not desirable and should be resorted to only when necessary. Sites containing Class 1.2 may not be located closer than the fragment distance from other open sites. The limitations of the quantity-distances listed in table 14-1 also are applicable.

Table 14-1. Special Requirements for Open Storage Between Earth Cover Magazines

Hazard class and division		Maximum kilograms (pounds) of HE		Minimum intersite distance meters (feet)		
	1.4		No limit		(400)	
(04)	1.2	45,360	(100,000)	121.9	(400)	
(08)	1.2	45,360	(100,000)	243.8	(800)	
(12)	1.2	45,360	(100,000)	365.7	(1,200)	
(18)	1.2	45,360	(100,000)	548.6	(1,800)	
	1.1	45,360	(100,000)	121.9	(400)	or fragment distance (if appropriate) whichever is greater.

(2) Sites not between earth covered magazines. Sites containing Class 1.2 shall not be stored closer than fragment distance from other sites.

No open storage site shall be located within 365.7 meters (1,200 feet) of above ground magazines. The limitations of the quantity-distances listed in table 14-2 also are applicable.

Table 14-2. Special Requirements for Open Storage Between Magazines That Are Not Earth Covered

Hazard class and division	Maximum kilograms (pounds) of HE	Minimum intersite distance meters (feet)	
1.4	No limit	30.5	(100)
(04) 1.2	No limit	121.9	(400)
(08) 1.2	226,800 (500,000)	243.8	(800)
(12) 1.2	226,800 (500,000)	365.7	(1,200)
(18) 1.2	45,360 (100,000)	548.6	(1,800)
1.1	45,360 (100,000)	(280)	(barricaded) or fragment distance (if appropriate) whichever is greater
	45,360(100,000) 155.4	(510)	(unbarricaded)
	113,400(250,000) 115.8	(380)	(barricaded)
	113,400(250,000) 211.8	(695)	(unbarricaded)

(3) General. Inhabited building distance and public traffic route distance shall be maintained around open storage sites as specified in Chapter 12.

i. *Storage of Bulk Initiating Explosives.* Bulk initiating explosives must not be stored dry and shall not be exposed to the direct rays of the sun. Glazed earthenware crocks of ample size to hold the double bag of material with covers of the plastic cap type to prevent evaporation and eliminate friction or abrasion when removed are used for normal storage. Proper selection and use of covers is required to prevent friction and pinch points. If long term storage in shipping containers is contemplated, the container must be equipped with a cover having a port for observation of the level of liquid therein. The viewing port must be covered with a transparent plastic which is known to be compatible with the initiating explosives being stored. As an expedient only, bulk initiating explosives may be stored in shipping containers that are not so equipped, provided they are stored in frostproof, earth covered magazines, with containers on end, only one tier high, and with passageways for inspection and handling. Bags of initiating explosives in storage containers must be under distilled water. Alcohol may be added to the distilled water to prevent freezing.

j. *Solid Propellants.* Propellants shall not be stored or shipped in damaged containers. When leaking containers are discovered, an examination of the contents shall be made for the nitrous odor of decomposing propellant. If any such condition is observed, the propellant shall be segregated or properly disposed of. Propellants and propelling charges in containers should be stored so that they can be readily inspected. They shall not be exposed to the direct rays of the sun.

k. *Small Arms Ammunition.* Boxed small arms ammunition shall not be used as barricades or dividing walls between stacks of other types of ammunition.

l. *Separate-Loading Ammunition, HE Loaded Except Explosive D.*

(1) Separate-loading projectiles must be handled with care. They shall not be stored without fuze-well closing plugs. Metal dunnage should be used where practicable.

(2) Class (18) 1.2 quantity-distances are the minimum acceptable for Class (18) 1.2 items, regardless of the quantities of the HE involved. For Class (18) 1.2 separate-loading projectiles, storage must comply with DARCOM Drawing 19-48-4102-1-2-14PE1001 in order to limit distance requirements to those prescribed by the Class (18) 1.2 quantity-distance table. If those projectiles are equipped with core-recessed lifting plugs, the Class 1.1 quantity-distance table applies when the total quantity of HE involved exceeds 6,804 kilograms (15,000 pounds) in above ground magazines, even if storage complies with DARCOM Drawing 19-48-4102-1-2-14PE1001.

m. *Separate-Loading Ammunition Explosive D Loaded, Class (12) 1.2.* Except where permanent block type storage methods are used, this type of projectile may be stored with distances between stacks not more than that required to permit inspections.

n. *Fixed and Semi-Fixed Ammunition.* Boxed fixed and semi-fixed ammunition shall not be used as barricades or dividing walls between stacks of other types of ammunition.

o. Rockets and Rocket Motors.

(1) Whenever practicable, rockets and rocket motors that are in a propulsive state should be stored nose down. Small rockets and missiles may be stored in standard earth covered magazines without regard to direction in which they are pointed except that they will not be pointed toward the door of the magazine. If not in a propulsive state, any rocket, rocket motor, or missile may be stored in any magazine without regard to the direction in which they are pointed.

(2) In above ground magazines where nose down storage is not practicable, items (in a propulsive state) shall be pointed in the direction which offers the least exposure to personnel and property in the event of fire or explosion.

(3) Rockets should be stored in a dry, cool magazine out of the direct rays of the sun. They should not be stored in locations where temperatures exceed 49°C (120°F). Prolonged exposure of rocket ammunition to either high or low temperatures may increase the normal rate of deterioration or render the motors more susceptible to ignition if subsequently handled improperly.

14-5. Shipment of Explosives and Ammunition.

a. *General.* Explosives and ammunition are routinely shipped via all common modes of transportation, i.e., railroad, truck, ships, and aircraft. However, due to the commodities hazardous nature each of the transportation modes rigidly adheres to its own specific set of regulations.

b. *Railroad Transportation.* The operation of railroads within a DARCOM establishment shall be in accordance with applicable current directives, particularly TM 55-200, Railroad Operating Rules and this regulation.

(1) Specifications for equipment. The regulations of the Department of Transportation, the Federal Railroad Administration, and the Association of American Railroads pertaining to safety devices, safety guards, design of equipment, etc. are mandatory for railway equipment involved in transporting materials between establishments. The same regulations should be followed for inspection, maintenance, and operation of railroad equipment within an installation.

(2) Transportation of hazardous materials.

(a) In addition to the requirements of other parts of this section, the rules in subparagraphs (b) through (i) below shall be followed.

(b) When cars containing explosives or other hazardous materials are received at the installation or held in yards, precautions must be taken to prevent accidents, particularly at night. These precautions must include provisions for quickly removing and isolating the cars in case of fire.

(c) Cars loaded with hazardous materials must be loaded and placarded as prescribed by Department of Transportation regulations before being offered for transportation. The carrying of hazardous materials on locomotives or other self-propelled rail vehicles is prohibited.

(d) Before cars are moved by a locomotive, the air brake hose must be coupled and tested to assure that the air brakes are in proper working condition and the car doors shall be closed.

(e) Empty cars shall not be removed from warehouses, magazines, buildings, or loading docks until all warning placards have been removed.

(f) Special care must be taken to avoid rough handling of cars. Cars must not be "cut off" while in motion and must be coupled carefully to avoid unnecessary shocks. Other cars must not be "cut off" and allowed to strike a car containing explosives. Cars must be so placed in yards or on sidings that they will be subject to a minimum of handling and be readily removed from danger of fire. Such cars must not be placed under bridges or in or alongside passenger sheds of station, and where avoidable, engines on parallel tracks should not be allowed to stand opposite or near them.

(g) "Dropping," "humping," "kicking," or the use of the flying switch is prohibited.

(h) Adequate measures such as guarding, patrolling, and safety inspection must be provided at all times. All such activity should be under positive administrative controls.

(i) Fire symbols or DOT placards shall be placed on each railroad car while transporting explosives or ammunition within a DARCOM establishment in order to provide a ready means of identifying the potential hazard should a fire occur.

(3) Placarded railcars. Placards shall be applied in accordance with DOT regulations to railcars transporting hazardous materials. Ammunition and explosives shall be loaded and braced in accordance with approved drawings.

(4) Car inspection. A car must not be loaded with any DOT Class A explosives unless it has been thoroughly inspected by a qualified employee of the carrier who shall certify that its condition conforms to DOT regulations. After a certified car has been furnished by the carrier, the shipper or his authorized employee must, before commencing the loading of any such car, inspect the interior thereof and after loading, certify to its proper condition. A certificate will be completed and signed where applicable. Shipments of Class B explosives may be loaded in a closed car or container car which is in good condition, into which sparks cannot enter, and with roof not in danger of taking fire through unprotected decayed wood. Wood floored cars must be equipped with spark shields. Such cars do not require a car certificate but must be placarded in accordance with paragraph 14-5b(3) above.

(5) Car certificates. The car certificate printed on strong tag board measuring 177.8 millimeters x 177.8 millimeters (7 by 7 inches) or 152.4 by 203.2 millimeters (6 by 8 inches) must be duly executed in triplicate. The original copy must be filed by the carrier at the forwarding station in a separate file and the other two must be attached to the car, one to each outer side on a fixed placard board or as otherwise provided.

(6) Leaking packages. Constant alertness must be maintained to detect, through characteristic odors, the leakage of hazardous materials from faulty packages. Leaking packages should be removed from cases and repaired, or if in tank cars, the contents should be transferred. If artificial light is necessary, only electric lights approved for the hazard involved shall be used. Leaking tank cars containing compressed gases shall be switched to a location distant from habitation and highways and proper action taken for transferring contents under competent supervision. Cars containing leaking packages or leaking tank cars must be protected to prevent ignition of liquid or vapors by flame from inspectors' lanterns or torches, burning fuses, switch lights, switch thawing flames, fires on side of track, or from other sources. All unnecessary movement of a leaking car discovered in transit must cease until the unsafe condition is remedied.

(7) Car loading of items containing ammunition and explosives. Loading methods prescribed by DARCOM drawings shall be followed for the loading and bracing of railway car shipments of military explosives and ammunition. The packages should be placed in position with no more force than is needed to secure a compact load and to prevent shifting and damage en route. Excessive or violent use of mauls shall not be permitted when positioning packages.

(8) Sealing cars containing explosives and ammunition. In addition to any other seals which may be used, cars containing explosives or ammunition shall be sealed. A cable seal lock will be used to secure car doors plus an upper rail lock. Serial numbers of seals will be placed on GBL (DOD 5100.76M and AR 55-355, Chapter 13). If the seal is not in place when the car is received, the car shall be treated as suspicious and shall be inspected. See AR 55-38 for instructions on recording details when shortage, pilferage, or apparent theft is involved.

(9) Inspection of cars before unloading.

(a) Rail cars containing explosives and ammunition entering a DARCOM establishment must be inspected. This inspection comprises the examination of the outside and under side of each car for damage such as defective brakes, couplings, wheel flanges, etc; to detect unauthorized and suspicious articles; to check correctness of individual car numbers and seal numbers against bills of lading. When the probability of sabotage is remote, such inspections may be accomplished from ground level without the aid of an inspection pit to discover unsafe structural and mechanical deficiencies of the car. During periods of emergency when sabotage may be attempted, and also to aid in the rapid inspection and movement of cars, an inspection pit should be provided.

(b) Cars of ammunition or explosives on which foreign and suspicious articles have been secreted or attached outside or underneath the car, or cars which show a defect that might affect the installation or contents of the car, shall be removed to the suspect car siding for additional inspection. In addition, during the times of national emergency, cars on which the seal numbers do not correspond to those shown on the bill of lading shall be treated as suspect cars and should be removed to the suspect car siding for additional inspection.

(c) Cars which satisfactorily pass the inspection outlined above may be considered reasonably safe but care must be exercised in breaking car seals and opening car doors because of the possibility of damage or shifting lading, leaking containers, etc. When the quantity and class of ammunition present in the classification yard does not exceed that permitted by the appropriate quantity-distance table, based on distance to adjacent targets, cars may be opened for inspection at that point, otherwise interior inspection should be accomplished after the cars have been spotted at the unloading point.

(10) Inspection of cars after unloading. Cars in which explosives or ammunition are received shall be inspected after unloading to see that they are clean and free from loose explosives or other flammable materials, and that the placards and car certificates are removed.

Explosives sweepings shall be destroyed.

(11) Damaged shipment. Any shipment received in a damaged condition as a result of inadequate or improper blocking and bracing or not loaded in accordance with appropriate DARCOM drawings shall be reported on Discrepancy Shipment Report (SF 361) in accordance with AR 55-38. If the damage was due to improper preservation, packaging, or packing, SF 364 (Report of Discrepancy) will be prepared in accordance with AR 735-11-2.

c. Motor Vehicle Transportation. The operation of motor vehicles within a DARCOM installation shall be in accordance with this and other applicable current regulations.

(1) Motor vehicle safety program. Current regulations, particularly AR 385-10, Army Safety Program, require the institution of a motor vehicle safety program as part of the overall safety program of a DARCOM installation. AR 385-55, Prevention of Army Motor Vehicle Accidents, contains detailed information for inclusion in such a program. Other pertinent regulations are AR 55-162, AR 55-203, AR 55-355, AR 55-357, AR 735-11-2, and AR 55-38.

(2) Motor vehicle shipment regulations. Motor vehicle shipments on public highways are governed by the Department of Transportation regulations. All motor vehicle shipments from a DARCOM installation shall comply in full with the applicable portions of DOT, state, and municipal regulations except as provided for in these regulations. Before any motor vehicle designated for movement over public highways may be loaded with ammunition or explosives (DOT Class A or B) and other dangerous articles, as specified in chapter 216, Section II, AR 55-355, the vehicle must be inspected and approved by a qualified inspector for compliance with AR 55-355 (DD Form 626) Motor Vehicle Inspection. After loading, lading must be inspected and approved. Driver selection, training, etc., for intraplant shipping and for operation of government owned trucks on public highways shall be in accordance with pertinent requirements of 49 C.F.R. Parts 390-397, Federal Motor Carrier Safety Regulations, FM 55-30, Army Transportation, Units and Operations, and FM 21-305, Manual for the Wheeled Vehicle Driver.

(3) Motor vehicle for explosives shipment. Cargo type trucks and truck-tractor drawn semitrailer vans are the preferred means for transporting ammunition, explosives, and other hazardous material. Other types of trailers should not be used by DARCOM installations for this purpose except where the material is sufficiently large to make handling by vans impractical (this restriction need not apply to licensed common carriers and contract equipment). Equipment used for transporting ammunition, explosives, and other hazardous material must meet the following requirements and these should be supplemented by local regulations as deemed necessary by the commander.

(a) Loading methods prescribed by DARCOM drawings shall be followed for the loading and bracing of motor vehicle shipments of military explosives and ammunition. The packages should be placed in position with no more force than is needed to secure a compact load and to prevent shifting and damage en route. Excessive or violent use of mauls shall not be permitted when positioning packages.

(b) Special precautions must be taken to avoid ignition of the material by the exhausts of automotive vehicles.

(c) The lighting system shall be electric. Batteries and wiring shall be so located that they will not come into contact with containers of explosives, ammunition, or other hazardous material. If exposed explosives or flammable vapors are encountered in a vehicle, only approved type portable lights should be permitted (certified by a nationally recognized testing organization for the specific hazardous location as defined by the National Electric Code).

(d) The interior of the truck body shall have all exposed ferrous metal covered with nonsparking material when transporting scrap and bulk explosives in containers which may be damaged and explosives become exposed. If the explosives transported consist of ammunition or explosives packaged for shipment in accordance with DOT specifications, it will not be necessary to cover the ferrous metal. Open body vehicles other than the flatbed trailer type used to transport large items such as rockets or missiles must have sides that are strongly made and securely fastened so that the items are safely retained. Where a top is required, it should be of a noncombustible or flame-proof material. Whenever tarpaulins are used for covering explosives, they will be secured by means of rope or tiedowns. Nails will not be used to fasten protective tarpaulins.

(e) All trucks (government and commercial) destined for offpost shipment over public highways shall be equipped with one (1) Class 1 O-BC rated portable fire extinguisher when transporting DOT Class A, B, or C explosives. Government motor vehicles involved only in on-post shipments shall be equipped, as a minimum, with two (2) Class 1-BC rated portable fire extinguishers; one mounted outside the cab on the driver's side of the vehicle and the other inside the cab. If government vehicles are equipped with an interior carbon dioxide or dry powder flooding device, only one extinguisher is required and should be mounted on the outside of the cab on the driver's side.

(f) Red lights are not permitted on the front of vehicles transporting explosives and ammunition.

(g) Trucks fueled with LP gas shall not be used to transport ammunition and explosives in ammunition areas.

(4) Inspection of vehicles. Government owned motor vehicles used for transportation of hazardous materials shall be inspected at frequent intervals by a competent person to see that mechanical condition and safety devices are in good working order and that oil and motor pans under engines are clean. Because of vehicle usage, this requirement is over and above the inspection requirements of TM 38-750. Daily inspection shall be made by operators to determine that: (a) Fire extinguishers are serviceable.

(b) Electric wiring is in good condition and properly attached.

(c) Fuel tank and piping are secure and not leaking.

(d) Brakes, steering, and other equipment are in good condition.

(e) The exhaust system is not exposed to accumulations of grease, oil, gasoline, or other fuels, and has ample clearance from fuel lines and other combustible materials.

(5) Mixed loading. The types of hazardous materials that may be loaded and transported together over public highways are established in 49 CFR 177.835(c) and 177.848. These DOT requirements shall be complied with for shipments over public highways.

(6) Instruction to drivers. Before motor vehicles loaded with hazardous materials leave a DARCOM establishment, drivers shall be informed of the nature of their cargo and methods of fighting fires involving the truck or its cargo. DD Form 836 (Special Instructions for Motor Vehicle Drivers) will be completed in accordance with the requirements of AR 55-355 and furnished such drivers. The provisions of TB 38572, Nuclear Weapons

Fire Fighting Procedures, shall be applied, when applicable.

(7) Inspection and movement of incoming shipments.

(a) Motor vehicles loaded with explosives, ammunition, or other hazardous materiel shall be carefully inspected by a competent person at a designated inspection station in accordance with AR 55-355 using DD Form 626. The inspection station should be located remotely from hazardous and populated areas.

(b) When inspection reveals that an incoming tractor is in an unsatisfactory condition, it should be disconnected from the trailer (at the inspection station) and moved to a position where it will not endanger any explosives.

(c) When inspection reveals that the trailer or its load is in an unsatisfactory condition, it shall be removed to a location which is at least inhabited building distance (not less than fragment distance for fragment producing items) for the material involved from inert and administration areas, hazardous locations, and the installation boundary. At this location, correction of unsatisfactory conditions shall be accomplished prior to movement to the destination of the vehicle within the installation. The route when moving from the inspection station to the isolated locations, insofar as possible, should be removed from built-up areas and areas where personnel concentrations are high.

(d) Vehicles which cannot be dispatched immediately to points where they are to be unloaded may be moved to a holding yard which shall be sited in accordance with paragraph 12-111.

(e) Incoming or outgoing ammunition and explosives loaded trailers that cannot be exchanged directly between the carrier and the DARCOM installation may be moved in to interchange yard. Quantity-distance provisions do not apply provided the trailers are moved expeditiously from the interchange yard. At least 3.048 meters (10 feet) separation should be maintained between trailers in an interchange yard.

(8) Damaged shipments. Any shipments received in a damaged condition as a result of inadequate or improper blocking and bracing or not being loaded in accordance with appropriate DARCOM drawings shall be reported on Discrepancy Shipment Report (SF 361) in accordance with AR 55-38. If the damage was due to improper preservation, packaging, or packing SF 364 (Report of Discrepancy) will be prepared in accordance with AR 735-11-2.

d. *Air Transportation.* The carriage of ammunition, explosives, and other hazardous materials by civil aircraft is regulated by the DOT. See 49 CFR 106-178, particularly Part 175. Criteria for the preparation and carriage of hazardous materials on military aircraft and certain Department of Defense contract airlift operations conducted under DOT Exemption 7573 are contained in TM 38-250.

(1) Military aircraft operating regulations.

(a) Operation of military aircraft shall be in accordance with requirements outlined in the applicable flight envelope, Army and/or Air Force regulations, and as further required by locally established regulations.

(b) If an aircraft carrying dangerous articles makes a forced landing and only minor repairs are necessary, the cargo need not be unloaded but repairs should be accomplished at a location separated from dissimilar exposures and other aircraft by the appropriate inhabited building distance for the cargo aboard. For major repairs, the plane shall be unloaded and the cargo stored in accordance with appropriate quantity-distance requirements. Appropriate protection should be afforded the cargo during inclement weather. If a landing is made for refueling purposes only, the cargo need not be unloaded. Refueling shall be accomplished at a location suitable for the performance of minor repairs as described above.

(c) Prior to take off or landing, the pilot must contact the tower for taxi, take off, or landing and parking instructions. The pilot shall, when requesting instructions, make known the contents of the cargo and shall request priority for his aircraft.

(d) When an aircraft containing ammunition or explosives is parked on a DARCOM installation in a designated, restricted, posted, and traffic controlled explosives parking or loading and unloading area, fire symbols will be posted at all normal approaches to the designated area. If parked in an area on a DARCOM installation which is not a designated, restricted, posted, and traffic controlled explosives parking or loading and unloading area, fire symbols will be placed at the nose, tail, and each side of the aircraft. Where the height of the aircraft does not readily permit attaching the fire symbols to the aircraft, the fire symbols may be mounted on stands approximately 1.5 meters (five feet) in height positioned adjacent to the aircraft where they are visible at long range. At other DOD installations and at non-DOD installations, placarding will be in accordance with the requirements of TM 38-250 and the requirements of the host installation.

(2) Permissible air shipments. Hazardous materials that may be shipped by civil air are identified in 49 CFR 172.101 along with the maximum net quantities per package and in Chapter 4 of TM 38-250 for shipments by military aircraft. External or internal transportation of electrically initiated explosive loaded items or components by helicopter will not be permitted without prior approval from the Commander, DARCOM. Packages must conform to the requirements of DOT regulations. Dangerous articles and other cargo must be firmly lashed to the aircraft structure or otherwise secured to prevent shifting in flight. Signaling devices, equipment necessary to promote safety in operations, small arms equipment in moderate quantities for personal use, and other items as permitted in Title 49 CFR part 175.10 may be carried without complying with the above requirements. Dangerous articles must be placed in a baggage compartment inaccessible to passengers during flight.

(3) Loading and unloading aircraft.

(a) Prior to loading or unloading ammunition, explosives, and other hazardous materials, the aircraft shall be electrically grounded so that the resistance to ground does not exceed 10,000 ohms.

(b) When loading or unloading aircraft containing ammunition or explosives, placards and fire symbols will be displayed as indicated in paragraph 14-5d(1)(d).

(c) Loading and unloading shall be done in accordance with quantity-distance requirements (para 14-5d(1)(b)).

(d) All ignition switches must be in the off position.

(e) Front and rear wheel chocks shall be in place.

(f) Military aircraft shall be loaded in accordance with AR 95-16, "Weight and Balance: Army Aircraft". Nonmilitary aircraft shall be loaded to comply with Civil Air Regulations.

(g) Nonmilitary airfields used for loading and unloading explosives will be provided with aircraft firefighting service equal to Army standards.

(h) At nonmilitary airfields used by US Army Flight Activities, aircraft rescue and fire protection is normally provided by the host. If protection provided by the host does not meet the standards established in AR 420-90, Fire Prevention and Protection, and the DARCOM supplement to AR 420-90, Army fire department personnel and/or auxiliary firefighters will be used during periods of Army flight activities, including loading and unloading of explosives.

(i) In addition to protection provided by the host, protection will be furnished through use of portable fire extinguishers by operating agency personnel trained as auxiliary firefighters.

(j) As a minimum, four portable fire extinguishers should be available for firefighting purposes during all loading and unloading of explosives. Recommended extinguishers are: two each pressurized water type extinguishers, utilizing Aqueous Film-Forming Foam (AFFF) liquid concentrate, six percent, MIL-F-24385, and two each Potassium Bicarbonate Base Dry Chemical Extinguisher, 13.6 kilograms (30 lb) capacity.

(4) Damaged shipments. Air shipments of explosives or ammunition received at a DARCOM establishment in a damaged condition or not loaded in accordance with applicable requirements shall be reported on Discrepancy in Shipment Report (SF 361) in accordance with AR 55-38 "Reporting of Transportation Discrepancies in Shipments." If damage was due to improper preservation, packaging, or packing, SF 364 (Report of Discrepancy) will be prepared in accordance with AR 735-11-2.

(5) Containers. Containers of explosives in aircraft shall not be opened or repaired.

e. *Water Transportation.*

(1) Transportation of explosives, ammunition, and other hazardous materials by water in vessels engaged in commercial service is regulated by the United States Coast Guard. Shipments overseas shall be made in accordance with the regulations of the carrier, the United States Coast Guard, or Department of the Army. (See AR 55-228, Transportation by Water of Explosives and Hazardous Cargo and TM 55-607 [Navy NAVSEA OP 3221 Rev. 1]. Loading and Stowage of Military Ammunition and Explosives Aboard Breakbulk Merchant Ships). Where route of travel requires passage under bridges, prior authorization from the responsible agency shall be obtained.

(2) Damaged shipments or shipments not stowed in accordance with pertinent regulations when received at a DARCOM establishment shall be reported on Discrepancy in Shipment Report (SF 361) in accordance with AR 55-38. If damage was due to improper preservation, packaging, or packing, SF 364 (Report of Discrepancy) will be prepared in accordance with AR 735-11-2.

(3) Containers of explosives and ammunition shall not be opened or repaired onboard a vessel except as required for dumping at sea or servicing weapons.

(4) Vessels in which explosives or ammunition are received shall be inspected after unloading to see that they are clean and free from loose explosives or other flammable materials and that warning placards, etc., are removed. Explosives sweepings will be destroyed.

CHAPTER 15

DISPOSAL, DESTRUCTION, DECONTAMINATION, AND DEMILITARIZATION OF ENERGETIC MATERIALS

15-1. Introduction. Most energetic materials cannot be safely disposed of by dissolving in solution and eliminating as sewage because they are insoluble in water, are generally toxic, and are hazardous to the environment. Disposal must be by burning, detonation, or chemical decomposition. The instructions in this chapter are for destroying limited quantities of explosive, pyrotechnic, incendiary, and smoke materials normally encountered during daily operations in laboratories, manufacturing plants, and storage facilities. When larger quantities are destroyed or reclaimed, special instructions will be furnished by the US Army Armament, Munitions, and Chemical Command (AMCCOM)/US Army Materiel Development and Readiness Command (DARCOM). When destruction is authorized, the provisions of all current applicable Army directives must be observed.

15-2. Disposal. Methods for destruction are generally based on the quantity and nature of materials to be destroyed, the facilities available, and the topography of the land. Destruction of explosive materiel will be accomplished by burning or detonation. The only exception to this policy is made in the case of small quantities of explosives which can be destroyed by chemical means as specified in paragraph 15-4. Burying energetic materials in the ground or dumping in waste places, pits, wells, marshes, shallow streams, rivers, inland waterways, or deep sea is absolutely prohibited. Existing locations, if known, of buried explosives and other energetic materials shall be appropriately marked with permanent type signs and measures shall be taken to prohibit unauthorized personnel from entering the area. Existing records identifying the type and quantity of energetic materials buried shall be maintained and the burial area shall be noted on installation drawings. Explosives which are dangerously deteriorated or cannot be definitely identified shall be destroyed by an approved method. Destruction shall not be undertaken without prior approval unless the organization or installation commander decides that immediate destruction of deteriorating explosives is necessary for the protection of life and property. All deteriorated materials thus destroyed must be accounted for, since Army regulations pertaining to the disposal of excess and surplus property apply to the destruction of such

unserviceable property. Prior approval for destruction of routine waste is not required. Compliance with applicable federal, state, and local environmental restrictions and permits is mandatory. Review of all SOPs for destruction of energetic materials by the Installation Environmental Coordinator is mandatory.

15-3. Destruction by Burning or Detonation.

a. Destruction Sites.

(1) Site selection, physical security, personnel training, emergency equipment, and procedures are governed by applicable federal, state, and local environmental regulations, particularly applicable hazardous waste regulations, and by the safety considerations which follow. Open burning and open detonation operations will be conducted in accordance with applicable air, hazardous waste, and other environmental permits. The site selected for the destruction of explosives and other energetic materials shall be located at the maximum practicable distance from all magazines, inhabited buildings, public traffic routes, and operating buildings but not less than 732 meters (2,400 feet) unless pits or similar aids are used to limit the range of fragments and debris. In all disposal and destruction activities, the quantity of explosives that may be destroyed safely at one time shall be determined carefully by starting with a limited quantity and then gradually increasing that quantity until the optimum amount consistent with safe and efficient operation is determined. When trials prove that fragments and debris are limited to lesser ranges, the appropriate inhabited building distances may be used. Sites must also be located in relation to the direction of prevailing winds so that sparks will not be blown toward explosives location. Where possible, natural barricades shall be utilized between the site and operating buildings or magazines. When destroying explosives by burning, the possibility that the mass may detonate must be recognized and appropriate protective barriers or distance separation should be used to protect personnel and property. Open air burning and detonation of explosives and pyrotechnics for demilitarization is prohibited between sunset and dawn.

(2) Dry grass, leaves, and other extraneous combustible material in amounts sufficient to spread fire shall be removed from a 200 foot radius from the point of destruction. The grounds should be of well packed earth and shall be free from large stones and deep cracks in which explosives might lodge. Explosive materials shall not be burned or detonated on concrete mats.

(3) Fire-fighting facilities shall be readily available to extinguish brush or grass fires and, if necessary, to wet down the ground between burnings and at the close of each day's operations.

(4) Ordinary combustible rubbish, explosives, and explosives contaminated material shall be destroyed at separate locations. Where limited space does not permit separate burning areas, part of the explosives destruction ground may be reserved for burning rubbish provided the two areas are not operated simultaneously, and the area where rubbish has been burned is wetted down and inspected before explosives burning is resumed. Combustible material should be burned in an incinerator complying with National Fire Protection Association Standard No. 82 or in a substantial, wire-mesh enclosure (not over three-fourths inch openings).

(5) The demolition area or burning ground shall be serviced with telephones or two-way radio communication. A change house serviced with electricity is desirable.

b. Explosives Material Awaiting Destruction.

Explosives material awaiting destruction shall be stored at not less than intraline distance, based on the largest quantity involved, from explosives being destroyed. The material shall be protected against accidental ignition or explosion from fragments, grass fires, burning embers, or detonating impulse originating in materials being destroyed.

c. Personnel Protection.

(1) Operational shields with overhead and frontal protection will be provided to protect personnel. Where circumstances warrant their use, complete personnel protection shall be provided. Such structures should preferably be located at the appropriate inhabited building distance for the quantity and type of materials being detonated but in no case will this distance be less than 300 feet. Employees must use such protection when explosive materials are destroyed by detonation or when explosive materials which may detonate are being burned. When Class 1.3 material is being destroyed by burning, personnel must remain at the greatest practicable distance from the burning site but in no case shall personnel be permitted closer than the applicable public traffic route distances.

(2) During disposal and destruction operations, the number of people in the area exposed to the hazard must be kept to a minimum. Warning signs or road blocks shall be posted to restrict the area and to ensure proper segregation of activities. At least two people are needed in disposal and destruction operations and operations shall be arranged so that not all of the personnel are exposed to an incident. Personnel engaged in burning explosives should be provided with flame resistant clothing.

d. Supervision and Training.

(1) The disposal area and its operations shall be under the direct control of an experienced, trained supervisor responsible for all activities within the area. The supervisor shall be present during all burning and demolition ground operations. During the supervisor's absence, a competent qualified person will be in charge. The alternate shall have sole custody of all ignition devices. Prior to actual burning or detonation of explosives, all personnel including the demolition ground supervisor will be evacuated to a safe distance or protective structure affording adequate protection but consistent with the need to monitor the total operation until it is complete.

(2) Personnel employed at the destruction area shall be thoroughly trained regarding the nature of the materials handled, the hazards involved, and the precautions necessary. The danger of using unapproved, improvised methods and other deviations must be thoroughly instilled in the minds of the employees. It is essential that thorough training and vigilant supervision be provided.

(3) In the absence of specific regulations covering any phase of the destruction of explosive material, complete information will be forwarded through command channels to the Commander, DARCOM, ATTN: DRCSF, requesting instructions and guidance.

e. Containers for Waste Explosives. Explosives destined for the burning ground shall be in original closed packages or in containers of fire-retardant materials which will not contribute to the existing hazard by readily producing sparks when contacting rocks, steel, or other containers. Bags or containers made from easily ignited material shall not be used. Containers shall have closures that will prevent spilling or leakage of contents when handled or if overturned. Closures shall be of a type that will not 'pinch or rub explosives during closing and opening. The closures and surfaces of containers openings shall be thoroughly cleaned of explosive contamination to minimize the hazard during closing or opening.

f. Servicing of Destruction Site.

(1) Trucks transporting explosive material to burning or demolition grounds shall meet the requirements of Chapter 14. No more than two persons shall ride in the cab.

(2) Upon arriving at a burning or demolition ground, trucks may distribute explosives containers or explosives items to be destroyed at sites where destruction is to take place. As soon as all items have been removed, trucks shall be withdrawn from the burning or demolition area to a safe location until destruction is completed. Containers of explosives shall not be opened until the truck has been withdrawn.

(3) Containers of energetic materials items to be destroyed at the destruction site shall be spotted and opened at least 10 feet from each other and from explosives material previously laid for destruction to prevent rapid transmission of fire in event of premature ignition.

(4) Empty containers shall be closed and moved a sufficient distance away to prevent charring or damage during burning of the explosives. Empty containers may be picked up by truck on the return trip after delivery of the next quantity to be destroyed.

(5) When materials being processed at destruction sites are to be handled by gasoline or diesel powered fork lift truck, the requirements of Chapter 12 will be observed. All such material handled will be properly packaged and must not be contaminated with explosives.

g. *General Burning Requirements.*

(1) Except in specific cases, energetic materials shall not be burned in containers.

(2) Bulk initiating explosives and others used predominantly in detonators and photoflash compositions shall be destroyed by detonation except that small quantities (not exceeding 28 grams) may be decomposed chemically.

(3) Loose explosives, other than initiating explosives, may be burned in beds not more than three inches deep. Wet explosives may require a thick bed of readily combustible material such as excelsior underneath and beyond to assure that all the explosives will be consumed once the materials are ignited. From the end of the layer of explosives the combustible material should be extended in a train to serve as the ignition point. When an ignition train of combustible material leading to the explosives is used, it must be arranged so that both it and the explosives burn in the direction from which the wind is blowing. The combustible train of the explosive, if ignited directly,

must be ignited by a safety fuse of a length which will permit personnel to withdraw safely to the protective shelter, or by black powder squib initiated by an electric current controlled from a distance or structure which assures safety to personnel should the total quantity of explosives detonate. In some cases, it may be necessary to tie two or more squibs together to assure ignition of the combustible train. When a misfire occurs, personnel shall not return to the point of initiation for at least 30 minutes. Not more than two qualified persons shall be permitted to examine the misfire.

(a) Loose, dry explosives may be burned without being placed on combustible material if burning will be complete and the ground does not become unduly contaminated. The ground must be decontaminated as frequently as is necessary for the safety of personnel and operations. Qualified inspectors shall examine the sites after each burning to determine if these requirements are met. Volatile flammable liquids shall not be poured over explosives or the underlying combustible material to accelerate burning, either before or during the burning of materials.

(b) Wet explosives shall not be burned without first preparing a bed of nonexplosive combustible material upon which the explosives are placed to assure complete burning. It is usually necessary to burn RDX wet to prevent detonation.

(c) Pyrotechnic materials collected as described in paragraph 15-5h(3) may be burned, except as noted below, by emptying the containers or buckets containing the oil and pyrotechnic mixture into a shallow metal pan and igniting as described above. The opened containers may be burned with the explosives. Burning of colored smokes and WP and HC mixes requires specific authorization of the Commander, AMC, ATTN: AMCSF.

(4) Parallel beds of explosives prepared for burning shall be separated by not less than 45.7 meters (150 feet). In repeated burning operations, care must be taken to guard against material being ignited from smoldering residue or from heat retained in the ground. Burnings shall not be repeated on previously burned-over plots for 24 hours unless the burning area has been thoroughly soaked with water and an inspection of the plot by competent personnel has been made to assure the safety of personnel during a subsequent burning operation.

(5) Some types of explosives and tracer or igniter compositions give off toxic fumes when burned. Proper protective respiratory equipment, such as hose masks, airline masks, and self-contained breathing apparatus shall be worn where such fumes are likely to be encountered.

h. *Materials for Detonating Explosives.*

(1) Detonation of explosives should, where practicable, be initiated by electric blasting caps using blasting machines or permanently installed electric circuits energized by storage batteries or conventional power line. Improvised methods for exploding electric blasting caps shall not be used. When items to be detonated are covered with earth, as specified in paragraph 15-3i(1), blasting caps shall not be buried beneath the ground level with the initiating charge. The initiating explosives should be primed with primacord of sufficient length to reach up through the covering to a point where the blasting cap may be connected above the ground level.

(2) Special requirements for using electric blasting caps and electric blasting circuits:

(a) Electric blasting caps, other electric initiators, electric blasting circuits and the like may be energized to dangerous levels by extraneous electricity such as: static electricity, galvanic action, induced electric currents, high tension wires, and radio frequency energy from radio, radar, and television transmitters. Safety precautions shall be taken to reduce the probability of a premature initiation of electric blasting caps and explosives charges.

(b) The shunt shall not be removed from the lead wires of the blasting cap until the moment of connecting them to the blasting circuit, except during electrical continuity testing of the blasting cap and lead wires. The individual who removed the shunt should ground himself or herself by grasping the firing wire prior to performing the operation in order to prevent accumulated static electricity from firing the blasting cap.

NOTE

After electrical continuity testing of the blasting cap, the lead wires must be short-circuited by twisting the bare ends of the wires together immediately after testing. The wires shall remain short circuited until time to connect them to the blasting circuit.

(c) When uncoiling the lead wires of blasting caps, the explosives end of the cap should not be held directly in the hand. The lead wires should be straightened out as far as necessary by hand and shall not be thrown, waved through the air, or snapped as a whip to unloosen the wire coils. Avoid loops by running lead wires parallel to each other and close together. If loops are unavoidable, keep them small. Keep wires on the ground in blasting layouts.

(d) Firing wires shall be twisted pairs. Blasting circuit firing wires shall at all times be twisted

together and connected to ground at the power source and the ends of the circuit wires where blasting cap wires are connected except when actually firing the charge or testing circuit continuity. The connection between blasting caps and circuit firing wires must not be made unless the power end of the circuit lead (firing wires) are shorted and grounded. The following methods should be followed when connecting electric type blasting cap lead wires to the firing circuit wires:

1 Check wires leading to the blasting machine for continuity and stray currents.

2 Test electric blasting cap wires for electrical continuity, and after the test, connect to wires leading to the blasting machines.

3 Evacuate all but two, persons from the area. Place cap into charge to be detonated.

4 Unshort firing lead wire circuit and check for continuity.

5 Connect firing lead wire to blasting machine and fire charges.

6 After firing, remove lead wires from blasting machine and twist the end to short them.

(e) Electric blasting or demolition operations and unshielded electric blasting caps should be separated from radio frequency energy transmitters by the minimum distances specified in tables 15-1, 2, and 3. These distances apply to all parts of the operation, including the lead wires of the cap and the firing wires circuit. Before connecting electric blasting caps to the firing wires, the blasting circuit must be tested for the presence of extraneous electricity by the following test:

1 Arrange a dummy test circuit, essentially the same as the actual blasting circuit except that a No. 47 radio pilot lamp of known good quality inserted in place of the blasting cap shall be used without applying electric current to the circuit. Any glow is evidence of the presence of possible dangerous amounts of RF energy and blasting operations in such areas must be performed with non-electric blasting caps and safety fuse.

2 The Dupont Blaster's Multimeter, Model 101, may be substituted for the No. 47 radio pilot lamp. If the exposure is to radar, television, or other microwave transmitters, the actual blasting circuit, with blasting cap included, but without other explosives shall be used to test for extraneous electricity. Personnel performing such tests must be provided protection from the effects of an exploding blasting cap. Distances prescribed in tables 15-1, 2, and 3 should be used as a guide in the selection of sites for electric blasting operations in the vicinity of radar and other microwave transmitters.

Table 15-1. Minimum Safe Distances Between RF Transmitters and Electric Blasting Operations

Transmitter power (watts)	Minimum safe distance meters (feet)			
	Commercial AM broadcast transmitters		HF transmitters other than AM broadcast	
100	228.6	(750)	228.6	(750)
500	228.6	(750)	518.2	(1,700)
1,000	228.6	(750)	731.5	(2,400)
4,000	228.6	(750)	1,463.0	(4,800)
5,000	259.1	(850)	1,676.4	(5,500)
10,000	396.2	(1,300)	2,316.5	(7,600)
25,000	609.6	(2,000)	3,657.6	(12,000)
50,000 ¹	853.4	(2,800)	5,181.6	(17,000)
100,000	1,188.7	(3,900)	7,315.2	(24,000)
500,000 ²	2,682.2	(8,800)	16,764.0	(55,000)

¹Present maximum power of US broadcast transmitters in Commercial AM Broadcast Frequency Range (0.535 to 1.605 MHz).

²Present maximum for international broadcast.

Table 15-2. Minimum Safe Distances Between Mobile RF Transmitters and Electric Blasting Operations

Transmitter Power Watts	Minimum Safe Distances Meters (Feet)									
	MF 1.6 TO 3.4 MHz Industrial		HF 28 TO 29.7 MHz Amateur		VHF 35 to 36 MHz Pub. Use 42 to 44 MHz Pub. Use 50 to 54 MHz Amateur Public Use		VHF 144 to 148 MHz Amateur 150.8 to 161.6 MHz Public use		UHF 450 to 460 MHz	
5 ¹										
10	12.2	(40)	30.5	(100)	12.2	(40)	4.6	(15)	3	10
50	27.4	(90)	67	(220)	27.4	(90)	10.7	(35)	6.1	(20)
100	38.1	(125)	94.5	(310)	39.6	(130)	15.2	(50)	9.1	(30)
180 ²							19.8	(65)	12.2	(40)
250	61	(200)	149.4	(490)	62.5	(205)	22.9	(75)	13.7	(45)
500 ³					88.4	(290)				
600 ⁴	91.4	(300)	231.6	(760)	96	(315)	35	(115)	21.3	(70)
1,000 ⁵	122	(400)	298.7	(980)	125	(410)	45.7	(150)	27.4	(90)
10,000 ⁶	381	(1,250)			396.2	(1,300)				

¹Citizens band radio (walkie-talkie) (26.96 to 27.23 MHz) - Minimum safe distance - five feet.

²Maximum power for 2-way mobile units in VHF (150.8 to 161.6 MHz range) and for 2-way mobile and fixed station units in UHF (450 to 460 MHz range).

³Maximum power for major VHF 2-way mobile and fixed station units in 35 to 44 MHz range.

⁴Maximum power for 2-way fixed station units in VHF (150.8 to 161.6 MHz range).

⁵Maximum power for amateur radio mobile units.

⁶Maximum power for some base stations in 42 to 44 MHz band and 1.6 to 1.8 MHz band.

Table 15-3. Minimum Safe Distances Between TV and FM Broadcasting Transmitters and Electric Blasting Operations

Effective radiative power (watts)	Minimum safe distances meters (feet)					
	Channels 2 to 6 and FM		Channels 7 to 13		UHF	
up to 1,000	304.8	(1,000)	228.6	(750)	182.9	(600)
10,000	548.6	(1,800)	396.2	(1,300)	182.9	(600)
100,000 ¹	975.4	(3,200)	701	(2,300)	335.3	(1,100)
316,000 ²	1,310.6	(4,300)	914.4	(3,000)	442	(1,450)
1,000,000	1,767.8	(5,800)	1,219.2	(4,000)	610	(2,000)
5,000,000 ³	2,743.2	(9,000)	1,889.8	(6,200)	914.4	(3,000)
10,000,000	3,109	(10,200)	2,255.5	(7,400)	1,066.8	(3,500)
100,000,000	1,828.8					(6,000)

¹Present maximum power, channels 2 to 6 and FM.

²Present maximum power, channels 7 to 13.

³Present maximum power, channels 14 to 83.

(f) Blasting or demolition operations shall not be conducted during an electrical storm or when a storm is approaching. All operations shall be suspended, cap wires and lead wires shall be short-circuited, and all personnel must be removed from the demolition area to a safe location when an electrical storm approaches.

(g) Prior to making connections to the blasting machine, the firing circuit shall be tested with a galvanometer for electrical continuity. The individual assigned to make the connections shall not complete the circuit at the blasting machine or at the panel, nor shall he/she give the signal for detonation until he/she is satisfied that all persons in the vicinity are in a safe place. When used, the blasting machine or its actuating device shall be in this individual's possession at all times. When the individual uses a panel, the switch must be locked in the open position until ready to fire and the single key or plug must be in his/her possession.

(h) Electric blasting caps must be in closed metal boxes when being transported by vehicles equipped with two-way radios and also when in areas where extraneous electricity is known to be present or is suspected of being present.

(3) Safety fuses may be used in the detonation of explosives where methods described in 15-3h(1) above cannot be accomplished. Safety fuse, when used, must be tested for burning rate at the beginning of each day's operation and whenever a new coil is used. Sufficient length of fuse shall be used to allow personnel to retire to a safe distance, but under no circumstances should a length be less than three feet or have less than 120 second burning time. Crimping of fuse to detonators must be accomplished with approved

crimpers. Safety fuse which is too large in diameter to enter the blasting cap without forcing shall not be used. Before igniting the safety fuse, all personnel except the supervisor and not more than one assistant shall retire to the personnel shelter or be evacuated from the demolition area.

(4) When using blasting caps involving the electric or non-electric system of destruction, the explosives end of the blasting cap shall always be pointed away from the body.

i. Detonation of Explosives.

(1) Explosives to be destroyed by detonation should be detonated in a pit not less than four feet deep and covered with not less than two feet of earth. The components should be placed on their sides or in position to expose the largest area to the influence of the initiating explosives with an adequate number of demolition blocks placed in intimate contact on top of the item to be detonated and held in place by earth packed over the demolition blocks. Bulk explosives can be used as a substitute for demolition blocks. Where space permits and the demolition area is remotely located from inhabited buildings, boundaries, work areas, and storage areas, detonation of shells and explosives may be accomplished without the aid of a pit. In either event, however, the total quantity to be destroyed at one time, dependent on local conditions, should be established by trial methods to assure that adjacent and nearby structures and personnel are safe from the blast effect or missiles resulting from the explosion. Rocket solid propellants should not be destroyed by detonation (paragraph 153Pt-).

(2) After each detonation, a search shall be made of the surrounding area for unexploded materials. Lumps of explosives may be picked up and prepared for the next detonation.

(3) In case of misfires, personnel shall not return to the point of detonation for at least 30 minutes after which not more than two qualified persons shall be permitted to examine misfire.

(4) AR 95-50 outlines the organization and functions of Regional Airspace Subcommittees and establishes uniform procedures for the handling of airspace problems. DARCOM installations will request, through channels, airspace clearance for demolition ground activities in accordance with these regulations.

j. *Dynamite.* Unopened boxes of exuding dynamite to be destroyed should be burned on a bed of combustible material without being opened. Precautions must be taken to protect personnel and property from possible detonation. Individual cartridges may be burned in a single layer not greater in width than the length of one cartridge, on a bed of combustible material. Dynamite awaiting destruction shall be shielded from the sun. Frozen dynamite is more likely to detonate during burning than normal cartridges. Destruction of dynamite by detonation may be accomplished where the location will permit this method of destruction. Care in priming to assure complete detonation of the quantity must be taken.

k. *Initiating Explosives.* When relatively large quantities of initiating explosives such as lead azide or mercury fulminate are to be destroyed, detonation is the best method. The bags containing the explosives should be kept wet while being transported to the demolition area. A predetermined number of bags should be removed from the containers, carried to the destruction pit, placed in intimate contact with each other and blasting caps used to initiate the explosives. The remaining explosives shall be kept behind a barricade with overhead protection during the destruction operations and located at a distance that will assure safety.

l. *RDX and PETN.* RDX and PETN may be burned as described in paragraph 15-3g. Since RDX and PETN are usually collected wet, they should be spread out and partially dried prior to burning. If the wet material will burn incompletely and with difficulty on the combustible bed, before any preparation for initiation is attempted fuel oil may be sprinkled over the bed of combustible material upon which the explosive is placed.

m. *Propelling Charges.* Propelling charges with igniters may be burned without slitting but in all cases igniter protector caps shall be removed from the charges to be burned. Protection must also be provided

against possible projection of the charges and explosion. Propelling charges must not be piled one on the other but shall be burned in single layer of charges laid side by side. Core igniter type charges in the single layer should be separated by a distance equal to one caliber.

n. *Black Powder.*

(1) Black powder is best disposed of by dissolving out the potassium nitrate in a closed system and disposing of the solid wastes separately. It may also be burned as described below. Upon drying, wet black powder may retain some of its explosive properties since the nitrate may not have been removed completely.

(2) Only tools of wood or spark-resistant metal will be used in opening the containers. The contents of only one container will be burned at one time; no quantity should exceed 50 pounds. The powder must be removed from the container and spread on the ground in a train approximately two inches wide, so that no part of the train comes closer than 10 feet to another part. To ignite the powder bed, use a train of flammable material approximately 25 feet in length placed so that the train and the bed of powder burn into the direction from which the wind is blowing. Emptied black powder containers will be thoroughly washed with water. Serious explosions have occurred during handling of supposedly empty black powder cans. Safety precautions shall be observed.

o. *Pyrotechnic Materials.* Loose pyrotechnic materials should be burned under the same conditions as black powder. Water-wet pyrotechnic materials may be burned in small quantities in furnaces designed and approved for that purpose.

p. *Rocket Solid Propellants.*

(1) Wherever practicable, propellant must be removed from rocket motors and destroyed by burning. In the event removal of the propellant is not practicable, the rocket motor should be positioned or restricted to prevent movement and propellant in the units shall be destroyed by static firing. When units are to be destroyed by static firing, complete details of the procedures must be submitted to the Commander, DARCOM, ATTN: DRCSF for approval.

(2) Rocket or missile propellants (solid) may weigh as much as several thousand pounds per grain and the polymer-oxidizer type may be extremely difficult to ignite at atmospheric pressures. Large size rocket motors for specific systems may be destroyed in accordance with instructions contained in technical manuals or technical bulletins applicable to such systems.

15-4. Destruction by Chemical Means. The chemical destruction of loose explosives, except as provided below, shall not be permitted unless approval is given by the Commander, DARCOM. Chemical methods must be supervised by qualified personnel having knowledge of chemistry. Chemical methods shall not be used in an attempt to destroy explosives which are enclosed or pressed into components such as detonators. The following procedures may be used under adequate supervision for 28 grams or less of the explosives named.

a. *Mercury Fulminate.* Place a quantity of aqueous sodium thiosulfate (hypo) solution (20 percent by weight of sodium thiosulfate) equal to 10 times the weight of mercury fulminate to be destroyed in a wood or earthenware container. While agitating the hypo solution, add water-wet mercury fulminate. The mixture shall be agitated by air or mechanical means but not by hand. Agitation must be continued until all fulminate has been dissolved, usually within two hours. Operators shall keep to the windward of the container or wear gas masks to avoid inhaling any cyanogen gas evolved.

b. Nitroglycerin. Small quantities of nitroglycerin may be neutralized or destroyed with a mixture of the following solutions: Solution A. Sodium sulfide (pulverized) (nine parts by weight) and water (30 parts by weight).

Solution B. Denatured ethyl alcohol (70 parts by weight) and acetone (20 parts by weight).

Do not combine the two solutions until immediately before use since potency of the mixed solutions diminishes on storage. This mixture should be used only for very small quantities of nitroglycerin (e.g., the oily film that adheres to surfaces after the nitroglycerin has been removed with sponges or absorbed in wood pulp or sawdust). Operators using this solution should wear rubber gloves.

c. Black Powder. Black powder may be completely destroyed by leaching or washing with large quantities of water and disposing of the washings separately from the residue.

d. Lead Azide.

(1) Lead azide accumulated on surfaces should be taken up with water wet cloths. The cloths should then be washed out in one of the solutions named below after which the complete desensitizing treatment is carried out in the solution. The cloths should be thoroughly washed with water before reuse.

Empty shipping bags should be turned inside out and treated while still water-wet.

(2) The preferred chemical method for destroying lead azide is to use a 20 to 25 percent aqueous solution of ceric ammonium nitrate. When small quantities of lead azide are destroyed in this manner the reaction is not violent. Since one of the products of the reaction is a gas, the ending of the gas evolution indicates completion of destruction.

15-5. Decontamination.

a. Decontamination Requirements.

(1) The cleansing of equipment, buildings, and grounds of explosive materials is a difficult, tedious, and sometimes hazardous operation. Because of the wide variety of materials, the existence of cracks, crevices, and cavities, and the possibility of explosions and the evolution of toxic or explosive gases, the operations and techniques must be made as simple as possible and various precautions taken to ensure safety of personnel and completeness of decontamination. Serious accidents have occurred through the subsequent handling or heating of incompletely decontaminated equipment.

DARCOM Safety Manual and DARCOM Regulations 385-series provide detailed safety measures.

(2) Loading plants, because of the use of a number of explosive materials, present particularly difficult problems of decontamination. The procedures appropriate to several different explosives manufacturing plants may be required for the decontamination of different parts of an individual loading plant.

(3) With the growing complexity of modern military explosives and propellants because of the introduction of new nonexplosive ingredients as well as mixtures of explosives, the problem of decontamination is increased correspondingly. New and special compositions, therefore, should be given careful technical consideration before decontamination operations are undertaken.

(4) A necessary function of decontamination is the collection of industrial wastes for destruction or reclamation. Elaborate controls are required to assure that these collection efforts are performed safely and economically without causing down-time in essential operations.

b. Decontamination and Dismantling Explosives Establishments. The decontamination and dismantling procedures to be followed for explosives establishments upon cessation of activity or upon conversion to other uses shall be outlined in detail as prescribed in TB 700-4. Requirements shall be developed for cleaning and dismantling equipment preparatory to repair or maintenance. Any equipment used in an explosive operation which may subsequently be used in operations with non-explosive material or explosives other than that for which the equipment was used originally shall first be given whatever treatment is necessary to insure that no explosive material remains. Decontamination markings and the use of DA Form 3803, Materiel Inspection Tag, should be included as a part of these requirements.

c. Decontamination Operations.

(1) Wherever practicable, decontamination is affected by the physical operations of washing, steaming, and vacuuming. While washing operations suffice for most pyrotechnic materials, some smoke and incendiary compositions present explosion hazards when wet with water. A small amount of water contacting hexachloroethane (HC) smoke mixture may cause an explosion and release of toxic fumes. Metal objects such as nitrators, centrifuges, tanks, piping, etc. are washed with water and steamed. Wooden objects such as railings, paddles, etc. and buildings such as dry-houses, and packing materials, gaskets, etc., are destroyed by removing and burning after preliminary cleaning. Earth that is so contaminated as to offer a fire or explosion hazard is wetted, scraped up, and burned at a burning ground.

(2) Free acid present in equipment requires neutralization as well as washing and a five percent solution of sodium carbonate (soda ash) is used for this purpose. Because of the uncertainty of complete removal of explosives in all cases by the physical methods described, chemical methods are used also to supplement these. Standard decontamination procedures include the decontaminating chemical shown by table 15-4.

d. Collection of Contaminated Industrial Wastes. Industrial wastes which may contain explosive materials and chemical agents shall be collected only in holding, storage, or disposal facilities specifically designed and permitted (i.e., having environmental operating permits) for that purpose. Disposal into sanitary sewers, septic

tanks, sanitary filter tanks, and unlined sumps, settling basins, or leaching pits is prohibited except as specifically authorized by permit. Sumps should be desensitized and cleaned at regular intervals. Cracks and crevices may contain explosives residue. Such residue must not be subjected to impact or friction from such sources as high pressure water streams, scraping tools or devices, etc., which may initiate the sensitive explosives. Quantities of initiating explosives in excess of 28 grams shall be destroyed by burning or detonation (see paragraph 15-3). Explosive materials to be removed from a settling basin should be maintained wet until removed. The more sensitive explosives should be maintained wet until destroyed. Materials containing powdered metals should be kept under water to prevent any dangerous rise in temperature which might otherwise be developed in the reaction between the metals and a small quantity of water.

Table 15-4. Decontaminating Chemicals

Contaminant	Decontaminating chemical
Lead azide	Ceric ammonium nitrate
Mercury fulminate	Sodium thiosulfate
Nitroglycerin	Methanolic sodium sulfite
Nitrocellulose	Sodium hydroxide
Smokeless powder	Sodium hydroxide and acetone
TNT	Sodium carbonate and sellite
Tetryl	Sodium carbonate and sellite or acetone
Pentolite	Acetone
White phosphorus	Copper sulphate solution

e. *Deposition from Waste Liquids.* When sumps or basins are properly designed, the wash water which passes beyond filters and basins should be free from significant amounts of explosive materials. If the effluent is discharged into a public stream, river, etc, it must not contain more explosives than permitted by local and state regulation. Consideration should be given to the possibility of deposition of explosive materials on the banks of streams or marshes during periods of drought, as well as to any possible subsequent precipitation of explosives with change of temperature, acidity, or concentration of the waste water. Where uncertainty exists regarding the composition of waste waters, competent technical advice and assistance should be obtained.

f. *Handling Water-Soluble Materials.* Where ammonium picrate, black powder, or other materials which are appreciably soluble in water are handled, the amount of dissolved material should be kept as low as practicable. Floors should be swept before washing down to reduce the quantity of dissolved material in the wash water.

g. *Destruction of Collected Solid Wastes.* Contaminated solid waste material should be taken in closed containers, as soon as practicable, to buildings set apart for its treatment or to the burning ground to be destroyed in an appropriate manner. Collected explosive and chemical wastes must not be disposed of by being buried or thrown in any streams or tidewater unless they are decomposed by water. Disposal of decomposed wastes in streams or tidewater will be allowed only if permitted by federal, state, and local laws and regulations.

h. *Collection of Explosives Dusts.*

(1) Dust collecting systems may be used to aid cleaning, to lessen explosion hazards, and to minimize industrial job-incurred poisoning and dermatitis.

(2) Examples of high explosives dusts which may be removed by a vacuum system are TNT, tetryl, ammonium picrate, composition B, and pentolite. A wet collector, which moistens the dust close to the point of origin and keeps it wet until the dust is removed for disposal, is preferred except for ammonium picrate which should be collected in a dry system.

(3) More sensitive explosives such as black powder, lead azide, mercury fulminate, tracer, igniter, incendiary compositions, and pyrotechnic materials may be collected by vacuum in this manner, provided they are kept wet with the wetting agent, close to the point of intake. The vacuum (aspirator) systems must be so arranged that the various types of explosives are collected separately or in a manner to avoid mixture of dissimilar hazards; i.e., black powder with lead azide. Provision should be made for the proper liberation of gases that may be formed. The use of vacuum systems for collecting these more sensitive materials should be confined to operations involving small quantities of explosives; for example, in operations involving fuzes, detonators, small arms ammunition, and black powder igniters. Potential fire and explosion hazards can be minimized by collecting scrap pyrotechnic, tracer, flare, and similar mixtures in No. 10 mineral oil. Satisfactory techniques include placing the oil in catch pans and scrap transporting containers at the various operations

throughout the plant, and by having individual oil containers serve as collection points for multiple operations. In the latter case, nominal quantities of dry scrap may accumulate at operating locations before they are delivered to collection points and placed in containers of oil. The level of oil should be kept at least 2.54 centimeters (one inch) above the level of any pyrotechnic mixture in the containers. Containers in which scrap explosives and pyrotechnic materials have been collected should be removed from the operating buildings for burning at least once per shift. Where oil is used, fire-fighting equipment satisfactory for Class B fires should be available. Carbon dioxide or foam extinguishers are recommended.

i. *Location of Collection Chambers.*

(1) Wherever practicable, dry type explosives dust collection chambers, except portable units as specifically provided for in paragraph 15-5j(3), should be located outside operating buildings in the open or in buildings exclusively set aside for the purpose. In order to protect operating personnel from an incident involving the collection chamber, a protective barrier must be provided between the operating building and the outside location or separate building where the collection chamber is placed. If the collection chamber contains 11.35 kilograms (25 pounds) of explosives or less, the protective barrier may be a 30.5 centimeters (12 inch) reinforced concrete wall located at least 2.44 meters (eight feet) away from the operating building. The collection chamber must be separated from cubicle walls by at least three feet. If the collection chamber contains more than 11.35 kilograms (25 pounds) of explosives and is separated from the operating building by a 30.5 centimeters (12 inch) reinforced concrete wall, the wall must be separated from the operating building by a minimum of unbarricaded intraline distance. The cubicle may be placed at a minimum of barricaded intraline distance from the operating building if the protective barrier meets the requirements of DARCOM safety regulations for operational shields (including the required three foot distance between the barrier and the explosives) and for the quantity of explosive in the collection chamber, or if the barrier complies with the requirements of paragraph 12-11v for barricades. Barricaded and unbarricaded intraline distances will be based on the quantity of explosives in the collection chamber.

(2) When it is not practicable to locate dry type collection chambers outside the operating building, a separate room within the building may be set aside for the purpose. This room shall not contain other operations nor shall it be used as a communicating corridor or passageway between other operating locations within the building when explosives are being collected. Walls separating the room from other portions of the operating buildings must meet the requirements specified in DARCOM safety regulations for the quantity of explosives in the collecting chamber. If more than one collection chamber is to be located in the room, the room must be subdivided into cubicles by walls meeting the requirements of DARCOM safety regulations and not more than one collection chamber shall be in a single cubicle.

(3) Stationary and portable wet type collectors may be placed in the explosives operating bays or cubicles provided the quantity of explosives in the collectors does not exceed five pounds. If placed in separate cubicles, the explosives limits for the collectors may be increased to the amount reflecting the capabilities of the cubicle walls as operational shields. For greater quantities, the location requirements set forth above are applicable.

j. Design and Operation of Collection Systems.

(1) Collection systems and chambers shall be designed to prevent pinching explosives (especially dust or thin layers) between metal parts. Pipes or tubes through which dusts are conveyed should have flanged, welded, or rubber connections. Threaded connections are prohibited. The system shall be designed to minimize accumulation of explosives dusts in parts other than the collection chamber. Accordingly, pipes or ducts through which high explosives are conveyed shall have long radius bends with a centerline radius at least four times the diameter of ducts or pipes. Short radius bends may be used in systems for propellant powder provided they are stainless steel with polished interiors. The number of points of application of vacuum should be kept to a minimum. So far as practicable, each room requiring vacuum collection chambers, but not more than two bays, shall be serviced by a common header to the primary collection chamber. Wet primary collectors are preferred. Not more than two primary collectors (wet or dry type) should be connected to a single secondary collector. If an operation does not create a

dust concentration which may produce a severe health hazard, manual operation of the suction hose to remove explosives dusts is preferred to a permanent attachment to the explosive dust producing machine. A permanent attachment increases the likelihood of propagation through a collection system of a detonation occurring at the machine. Interconnection of manually operated hose connections to explosives dust-producing machines should be avoided.

(2) Two collection chambers should be installed in series ahead of the pump or exhauster to prevent explosives dust from entering the vacuum producer in dry vacuum collection systems.

(3) Dry type portable vacuum collectors shall not be located in a bay or cubicle where explosives are present or in inclosed ramps but may be positioned outside the building or in a separate cubicle having substantial dividing walls for quantities of explosives not exceeding five pounds. Wet type portable vacuum collectors may be placed in explosives operating bays or cubicles provided the quantity of explosives in the collector is limited in accordance with the requirements of paragraph 15-5i. For dry collection of quantities in excess of 2.3 kilograms (five pounds) or wet collection of quantities in excess of 6.8 kilograms (15 pounds), the further provisions of paragraph 15-5i shall apply.

(4) The design of wet collectors shall provide for proper immersion of explosives, breaking up air bubbles to release airborne particles, and removal of moisture from the air before it leaves the collector to prevent moistened particles of explosives from entering the small piping between the collector and the exhauster or pump.

(5) At least once every shift, explosives dust shall be removed from the collector chamber to eliminate unnecessary and hazardous concentrations of explosives. The entire system should be cleaned weekly, dismantling the parts if necessary.

(6) The entire explosives dust collecting system shall be electrically bonded and grounded. The grounds must be tested frequently.

(7) Slide valves for vacuum collection systems are permitted. There shall be no metal-to-metal contacts with the metal slide. An aluminum slide operating between two ebonite spacer bars will not constitute a hazard.

15-6. Demilitarization.

a. Pollution Abatement and Waste Recycling Requirements. The problem of what to do with outdated ammunition to prevent both pollution and hazardous situations from occurring is an enormous one which dates back more than a century. At first glance, two answers become apparent, i.e., complete disposal or partial disposal with some recycling. The various chemical constituents of the warhead, propellant, or pyrotechnic are not only explosively hazardous but are frequently of a toxic character. Disposal by dumping into the world's oceans, incineration, or detonation have been shown to be not only dangerous but an addition to world pollution and as such, a persistent universal health hazard. Further, the problem of pollution from all sources (military and non military) became so acute in the United States in the early 1970's that both Presidential Executive Orders and Congressional legislation required that federal and private facilities be set up or converted to handle both pollution abatement and waste recycling. To this end, all US Military services (plus the AEC, now NRC) launched or vigorously continued their efforts to develop safe, efficient, and non-polluting methods of disposal or recycling of outdated ammunition, in particular, their energetic material content.

b. Recovery and Reclamation of Energetic Materials. Certain energetic materials such as relatively stable high explosives and pyrotechnics can be easily reclaimed and reloaded, but solid propellants which may have a limited storage life, require significant degrees of processing before they can be recycled or converted to other products. In many instances energetic material component recovery was not economically feasible.

Energy conservation requirements strongly favor the recycling of energetic materials over pollution-free disposal (or the wasting) of these materials.

c. Redesign of Ammunition for Use of Recycled Energetic Materials. To have a safe, effective, and efficient program of ammunition recycling, ammunition that can be readily recycled must be available. To this end a new concept in ammunition design has been evolved. Ammunition items (inclusive of explosives, propellants, and/or pyrotechnics) will be designed and fabricated in such a manner as to be easily and safely recycled.

d. Explosives Reclamation. Preliminary removal of the high explosive charge from a mine, projectile, or shell usually involves the use of hot water or steam to liquefy the explosive which is then separated from the water by gravity, or contour drilling followed by high pressure water erosion to remove the high explosive residue. The new concept of ammunition which can be readily recycled by design, however has resulted in the prepackaging or encapsulation of the entire high explosive charge for easy and safe removal. After separation of the casing from the charge, table 15-5 summarizes the various procedures which have been developed to recover the individual constituents of the charge.

Table 15-5. High Explosive Reclamation

<i>Constituent-composition</i>	<i>Explosive recovery technique</i>
HBX from H-6 composition	A hot water erosion process removes the HBX from the warhead. Then the water explosive mixture flows into a vacuum kettle where the water is removed. The dried explosive is then dispensed through a multiported dispenser to an endless steel belt where it solidifies and is broken into flakes as it flows off the belt. Remelting and composition adjustment to form new HBX types or H-6 is then easily performed.
HMX from PBX 9404 composition	Preferential extraction of the binder is performed with concentrated (70 percent) technical grade nitric acid by adding the acid to the PBX component and heating the mixture to between 700C and 95°C for several minutes. After cooling to room temperature, the excess acid is withdrawn. The extraction procedure is repeated until the HMX is free of the binder. The acid is then diluted with water and the HMX collected by vacuum filtration. Yield is 82.0 to 86.6 percent.

Table 15-5. High Explosive Reclamation (Cont)

Constituent-composition	Explosive recovery technique
HMX from PBX compositions developed after 1974	The binders which are incorporated in these post-1974 compositions are selected for their heat sensitivity. For example, polypropylene-glycol-urethane can be degraded when heated to 160°C for 10 hours. The HMX can then be extracted with methylene chloride.
RDX from RDX composition A and RDX and TNT RDX composition B	Selective batch extraction of the wax in composition A using benzene in a soxhlet apparatus leaves the RDX. The TNT in composition B is extracted either batchwise or continuously in from soxhlet apparatus with benzene subsequent to extraction of the wax with heptane. This procedure leaves the RDX intact.
RDX plus 0.03 percent desensitizer from composition A-3	The wax is removed (leaving the RDX) by selective solution using a batch process in which a benzene-water azeotrope is continuously circulated through an agitated composition A-3/benzene slurry.
RDX from composition B	Selective solution of TNT and desensitizer with benzene in a closed system.
RDX from composition C-3	Selective solution of all but the RDX content of the composition is accomplished by agitation of a slurry of composition C-3 and methanol (or acetone) in a kettle.
Tetryl from tetryl-metal stearate mixture	Tetryl is selectively dissolved by continuous acetone extraction followed by water precipitation to recover the tetryl.
Tetryl from tetryl-stearic acid mixture	Separation is accomplished by reaction of the mixture with a dilute solution of the sodium bicarbonate or carbonate at 90°C, cooling to room temperature, and then washing the tetryl with cold water. The tetryl is then recrystallized from acetone-water. Large pellets of the tetryl-stearic acid mixture require pre-treatment with an acetone soak.
TNT from amatol	The TNT is extracted with boiling water through a stainless steel mesh thus removing dirt and metal impurities. After the molten TNT settles, it is drawn off and re-washed with boiling water under agitation four times in a similar fashion. The TNT is then precipitated in cold water or run directly into graining kettles for immediate reuse.
TNT from 10/90 and 50/50 pentolite	TNT is selectively dissolved with benzene at 70°C followed by cooling, filtering, and evaporation of the benzene to obtain the TNT.
TNT and tetryl from tetrytol 75/25	TNT is selectively dissolved using a xylene-heptane (50/50) mixture. This procedure recovers 90 percent of the tetryl.
TNT from warheads	TNT is selectively dissolved using xylene.

e. Propellants Reclamation. Solid ammunition propellants are difficult to recycle because the smokeless base(s) (nitrocellulose and/or nitroguanidine) used in the ammunition will deteriorate with age. Solid rocket propellants in many instances can be recovered as shown in table 15-6. However, the polymeric binder used in solid rocket propellants is a cross-linked material which is insoluble in solvents making it impossible to remove the binder simply by solvent extraction. Furthermore, the finely divided metal and oxidizer particles are intimately coated with the binder which is

also impervious to water making it impossible to remove a water-soluble oxidizer from the metal and binder. This impediment in recycling calls for chemical cleavage of the binder linkage or the use of binder molecular structures which can be thermally degraded. Liquid propellants, on the other hand, do not present much of a recycling problem. They usually consist of a fuel and an oxidizer which are both usually basic industrial chemicals that can be stored separately for an indefinite period of time. Hence, liquid propellants are always essentially recovered before actual use.

Table 15-6. Propellant Reclamation

<i>Constituent-ammunition item or composition</i>	<i>Propellant constituent recovery technique</i>
Ammonium perchlorate (or other oxidizer) and fuel from binder	The oxidizer is usually water-soluble. The oxidizer extraction process is efficiently performed with the cooling water used to cool the propellant grains during the shredding process. The oxidizer is then recrystallized and reused. The inert binder and metal fuel are further separated for the purpose of recovering the metal either before or after incineration.
Contaminants from .50 cal ammunition	The removal of contaminating igniter and tracer compositions from .50 cal propellant is performed by selective solution using a water spray from a fish-tail type of sprayer which emits the water at a 90 degree angle to the surface of the propellant powder as it is vibrated on a Day Roball Gyrator screen.
Nitrocellulose from deteriorated propellants	Recovery of nitrocellulose is performed by solution or dispersion underwater, then careful molding to give a colloidal composition of nitrocellulose.
Nitrocellulose from single-base cannon powder containing DNT and dibutylphthalate (DBP)	Preferential solution of the DNT and DBP uses an extraction process with a mixture of benzene water.
Nitroglycerin propellants	A process of selective adsorption is used; i.e., a benzene solution of the various constituents of the composition are selectively adsorbed on materials such as Fullers earth, silicic acid, activated carbon, activated silicates, etc., followed by a desorption process.
Reclamation of cured polysulfide-perchlorate propellants	The waste cured propellant is reduced to a small particle size by passing it through a laboratory mill. It is then added to the extent of 20 percent of the total mixture to a normal mixture of propellant. The waste propellant re-liquefies to its precured state in the mixer by means of a molecular weight redistribution between the low molecular weight liquid polymer and the high molecular weight solid polymer. The reaction is complete in about 10 minutes.

f. Pyrotechnics Reclamation. As can be seen from the data in table 15-7, little work has been done on recycling the majority of pyrotechnic basic materials with the exception of the magnesium and sodium nitrate in illuminating flares and dyes in smoke components.

Current investigations consist of attempts to recover the pyrotechnic materials from signal flares. However, the work to date can be considered as a pilot activity which can be further developed and applied to other pyrotechnic items and components.

Table 15-7. Pyrotechnic Reclamation

Constituent-composition	Pyrotechnic constituent recovery technique
Dyes from smoke compositions	Preferential solution with water leaves the dye plus other water insolubles for storage and later reuse in new units. The dyes can be further separated by extraction with a dilute aqueous mineral acid such as hydrochloric acid. If water is present in the dye, it can be extracted with alkaline solutions.
Magnesium from flare compositions	Water is used to selectively dissolve sodium nitrate and most of the binder material. The residual magnesium is then dried and sieved. In some instances the binder requires acetone or similar solvents.

15-15(15-16 blank)

**APPENDIX A
CHARACTERISTICS AND DATA**

TABLE A-1. Sensitivity Test Values of Explosives

Material	Impact test with 2 kilogram weight		Pendulum friction test, percent explosions	Rifle bullet test, percent explosions	Explosion temperature test, °C	Minimum detonating charge, gram of-		Electrostatic, sensitivity, joules
	PA APP (% TNT)	BM APP (%TNT)				lead azide	mercury fulminate	
Primary explosives								
Lead azide (pure)	29		100	-	-	-	-	0.01
DLA	29 to 43	13 to 28	-	-	340	-	-	-
SLA	14	30	-	-	350	-	-	-
CLA	14 to 21	-	-	-	-	-	-	-
PVA-LA	29 to 35	13 to 16	-	-	344	-	-	-
RD-1333	36	15	-	-	340	-	-	-
DCLA	21 to 42	-	-	-	345	-	-	-
Mercury fulminate	14	5	100	-	210	-	-	0.025
Diazodinitrophenol	14	5	100	-	195	-	-	0.25
Lead styphnate (normal)	21	8	-	-	282	-	-	0.0009
Tetracene	14	7	-	-	160	-	-	0.01
Aliphatic nitrate esters								
BTN	7	16	-	-	230	-	-	-
DEGN	-	-	-	-	237	-	-	-
Nitrocellulose								
Pyrocellulose (12.75/o N)	21	8	-	100	170	-	-	-
Blended	21	8	-	100	200	-	-	-
Guncotton (13.3% N)	21	9	-	100	230	0.10	-	-
Nitroglycerin	7	16	100	100	222	-	-	-
Nitrostarch	36	-	-	-	217	-	-	-
PETN	43	17	5	100	215	0.03	0.17	0.036
TEGN	307	100 +	0	-	225	-	-	-
TMETN	-	-	100	-	235	-	-	-
Nitramines								
HMX	-	32 shoe) 0 (fiber shoe)	100 (steel)	-	327	0.30	-	-
RDX	57	33	20	100	260	0.05	0.19	-
EDDN	64	75	-	-	445	-	2.0	-
Haleite	-	48	0	-	190	0.21	0.13	-
Nitroguanidine	-	47	0	0	275	0.20	-	-
Tetryl	57	26	0	70	257	0.10	0.19	-

TABLE A-1. Sensitivity Test Values of Explosives (Cont)

Material	Impact test with 2 kilogram weight		Pendulum friction test, percent explosions	Rifle bullet test, percent explosions	Explosion temperature test, °C	Minimum detonating charge, gram of-		Electrostatic, sensitivity, joules
	PA APP (% TNT)	BM APP (%TNT)				lead azide	mercury fulminate	
Nitroaromatics								
Ammonium picrate	121	100+	0	30	318	-	0.85	-
DATB	200	-	-	-	-	-	-	-
HNS	50	-	-	-	-	-	-	-
TATB	79	-	-	-	520	0.30	-	-
TNT -	-	-	0	0	475	0.26	0.24	0.06
Ammonium nitrate	221	100 +	0	0	no explosion	-	-	-
Binary								
Amatol	93 to 100	-	0	0	254 to 300	-	-	-
Composition A3	125	-	0	0	250 to 280	0.25	0.22	-
Composition B	100	75	-	20	278	0.20	0.22	-
Composition C3	100	100 +	0	40	280	-	-	-
Composition C4	> 100	-	0	20	263 to 290	0.20	-	-
55/45 Ednatol	-	95	0	0	190	0.22	0.22	-
75/25 Octol	170	0	-	-	350	0.30	-	-
70/30 Octol	136	-	0	-	335	0.30	-	-
50/50 Pentolite	86	34	0	80	220	0.13	0.19	-
Picratol	100	100 +	0	0	285	-	-	-
70/30 Tetrytol	78	28	0	-	320	0.22	0.23	-
Tritonal	71	73	0	60	470	0.30	-	-
Ternary								
Amatex 20	107 to 129	-	-	6	240	-	-	-
HBX-1	75	-	-	75	-	-	-	-
HBX-2	80	-	-	80	-	-	-	-
HTA-3	121	-	0	90	370	-	-	-
Minol-2	93	35	-	-	224 to 260	-	-	-
Torpex	50	75	-	100	260	-	0.18	-
Quaternary								
DBX	71	-	-	49	200	0.20	-	-

Table A-2. Effects of Explosives

Material	Brisance measured by-		Fragmen- tation of shell percent TNT	Copper cylinder compression test	Rate of detonation		Ballistic pendulum test percent TNT	Trauzl lead block test percent TNT	Relative blast effect, percent TNT	
	Sand test (% TNT)	Plate dent test percent TNT			At density	Meters per second			Pressure	Impulse
Primary explosives										
Lead azide (pure)	40	-	-	-	4.68	5,400	-	40	-	-
DLA	38	-	-	-	-	-	-	-	-	-
Mercury fulminate	27.3 to 59	-	-	-	4.17	5,400	-	37 to 50	-	-
Diazodinitrophenol	94 to 105	-	-	-	1.63	7,100	-	110	-	-
Lead styphnate (normal)	22 to 53	-	-	-	2.9	5,200	-	42	-	-
Tetracene	40 to 70	-	-	-	-	-	-	51 to 63	-	-
Potassium dinitro- benzofuroxane	93	-	-	-	-	-	-	-	-	-
Aliphatic nitrate esters										
BTN	103	-	-	-	-	-	-	-	-	-
DEGN	100	-	-	-	1.38	6,760	127	144 to 150	-	-
Nitrocellulose										
Pyrocellulose (12.75% N)	94	-	-	-	-	-	-	-	-	-
Blended (13.30/o N)	99	-	-	-	-	-	-	-	-	-
Guncotton	102	-	-	84	1.3	7,300	125	136 to 147	-	-
High nitrogen	108-120	-	-	-	-	-	-	-	-	-
Nitroglycerin	120	-	-	-	1.6	7,700	140	185	-	-
Nitrostarch(13.4% N)	-	-	-	83	0.90	6,190	145	-	-	-
PETN	129 to 141	127	-	-	1.773	8,300	145	170	-	-
TEGN	30.6	-	-	-	1.33	2,000	-	-	-	-
TMETN	91	-	-	-	-	-	-	140	-	-
Nitramines										
HMX	125	-	-	1.89	1.89	9,110	170	159 to 165	-	-
RDX	125 to 145	135 to 141	141	-	1.770	8,700	150	170	-	-
EDDN	96	100	-	-	1.50	6,915	120	125	-	-

Table A-2. Effects of Explosives (Cont.)

Material	Brisance measured by-		Fragmen- tation of shell percent TNT	Copper cylinder compression test	Rate of detonation		Ballistic pendulum test percent TNT	Trauzl lead block test percent TNT	Relative blast effect, percent TNT	
	Sand test (% TNT)	Plate dent test percent TNT			At density	Meters per second			Pressure	Impulse
Haleite	109 to 119	113 to 122	117 to 147		1.55	7,883	136	122 to 143	-	-
Nitroguanidine	73.5 to 84	95			1.70	8,100	104	78 to 101	-	-
Tetryl	113 to 123	115	121	117 to 125	1.71	7,850	145	125 to 145	-	-
Nitroaromatics										
Ammonium picrate	78 to 82.591	99			1.63	7,154	98	-	-	--
DATB	120	-	-		1.79	7,585				
HNAB	-	-	-		1.77	7,250	-		123	--
HNS	120	-	-		1.70	7,000	-	-	-	--
TATB	90	-	-		1.937	8,000	-	-	-	--
TNT	-	-	-		1.636	6,826	-	-	-	--
Ammonium nitrate	-	-			1.0	2,800	-		75	
Binary										
Amatol	74 to 94 -		81	-	1.6	5,300 to 6,550	122	116 to 126	97	87
Composition A3	107 to 115	126	150	-	1.6	8,200	132	144	-	
Composition B	113	129 to 132	142	-	1.68	7,840	133	131	110	110
Composition C3	112	114 to 118	133	-	1.6	7,625	126	117	105	109
Composition C4	116	115 to 130	-	-	1.59	8,040	130	-		
CH6	128 -	-	-	-	8,223					
55/45 Ednatol	112	112	118		1.63	7,340	119	119	108	110
75/25 Octol	-	-			1.81	8,364 to 8,643	-			
70/30 Octol	-	-			1.80	8,310 to 8,377	-			
50/50 Pentolite	114	126	131	113	1.62	7,402	126	121	105	107
Picratol	94	100	102	-	1.67	6,970	100	-	100	100
70/30 Tetrytol	111	118	119		1.61	7,350	-	120		
80/20 Tritonal	114	93	91		1.76	6,770	124	153	113	118

Table A-2. Effects of explosives (Cont)

Material	Brisance measured by-		Fragmen- tation of shell percent TNT	Copper cylinder compression test	Rate of detonation		Ballistic pendulum test percent TNT	Tares lead block test percent TNT	Relative blast effect, percent TNT	
	Sand test (% TNT)	Plate dent test percent TNT			At density	Meters per second			Pressure	Impulse
Ternary	-	-			1.61	6,944				
Amatex 20	-	-			1.75	7,222	-		121	116
HBX-1	102		129		1.86	6,920	-		121	125
HBX-3	93.5	-	68	-	-	7,866	-			
HTA-3	128	-	-	-	1.77	6,200	143	165		
Minol-2	86	66	-	-	1.8	7,660	134	161	122	125
Torpex	122	120	126	-						
Quanternary										
DBX	112	-	-	-	1.76	6,800				

Table A-3. Thermochemical Characteristics of Explosives

Material	Heat of combustion, calories per gram at constant	Heat of formation kilogram calories per mole	Products of explosion	
			Heat, calories per gram (H ₂ O gas)	Gas, milliliters per gram
Primary explosives				
Lead azide	-	-112 to -126.3	367	308
Mercury fulminate	938	-221 to -226	427	315
Diazodinitrophenol	-	956	820	-
Lead styphnate	1,251	92.3	460	440
Tetracene	-	270	658	1,190
Aliphatic nitrate esters				
BTN	2,167	368	1,458	-
DEGN	2,792	-99.4	1,161	-
Nitrocellulose				
Pyroxyln (12% N)	-	-216	1,020	-
Guncotton (13.350/o N)	2,313	-200	1,020	883.2
High nitrogen (14.14% N)	-	1,810	-	-
Nitroglycerin	1,603	-90.8	1,486	715
PETN	1,957	-128.7	1,510	790
TEGN	3,428	-603.7	750	-
TMETN	2,642	-422	-	-
Nitramines				
HMX	2,231 to 2,253	11.3 to 17.93	1,480	-
RDX	2,259 to 2,284	14.71	1,480	908
EDDN	2,013	156.1	128 to 159	-
Haleite	2,477	20.11	1,276	908
Nitroguanidine	2,021	20.29	880	1,077
Tetryl	2,914	4.67 to 7.6	1,450	760
Nitroaromatics				
Ammonium picrate	2,745	95.82	800	-
DATB	-	-97.1 to -119	910	-
HNAB	-	-58 to -67.9	1,420	-
HNS 3,451	-	-13.9 to 1.87	1,360	-
TATB	2,850	-33.46 to -36.85	1,018	-
TNT	3,563 to 3,598	-10 to -19.99	1,290	730
Ammonium nitrate	-	88.6	381	980

Table A-4. Stability Test Values of Explosives

Material	75°C international test, percent loss in weight	100°C Heat Test, percent loss in weight in-		Vacuum stability test						
		1 st 48 hr	2 nd 48 hr	Sample, gm	100°C		120°C		150°C	
					ML	HR	ML	HR	ML	HR
Primary explosives										
Lead azide										
DLA		0.34	0.39	1	0.32	40	0.46	40	-	-
SLA		0.08	0.16	-	-	-	-	-	-	-
PVA-LA-	-	0.13	-	1	0.20	40	0.44	40	-	-
RD1333-	-	0.30	0.30	1	-	-	0.43	40	-	-
Mercury fulminate	0.18	-----explodes-----								
Diazodinitrophenol	0.24	2.10	2.20	5	7.6	40				
Lead styphnate (normal)	-	1.5	1.5	1	0.4	40	0.4	40		
Tetracene	0.5	23.2	3.4							
Potassium dinitrobenzofuroxane	0.03	0.05								
Lead mononitroresorcinate	-	-	-	2.3	-	-	0.4	40	-	-
Aliphatic nitrate esters										
Nitrocellulose (12%N)	-	0.3	0	1	-	-	5.0	48	-	-
Nitroglycerin	3.5	3.5	1	11 +	16					
PETN	0.02	0.1	0.0	5	0.5	40	11 +	40	-	-
TEGN	-	1.8	1.6	1	-0.45	40	0.8	8		
							to 0.99			
TMETN	-	2.5	1.8	-	-	-	-	-	-	-
Nitramines										
HMX	-	0.05	0.03	5	0.37	40	0.45	40	0.62	40
RDX	0.03	0.04	0	5	-	-	0.9	40	2.5	40
Haleite	0.01	0.2	0.3	5	0.5	48	1.5	48	11 +	
							to 2.4			
Nitroguanidine	0.04	0.48	0.09	5	0.4	40	0.5	40	-	-
Tetryl	0.01	0.1	0.0	5	0.3	40	1.0	40	11 +	12
Nitroaromatics										
Ammonium picrate	0.12	0.1	0.1	5	0.2	40	0.4	40	0.4	40
DATB	-	-	-	1	-	-	0.03	48		
HNS	-	>1	-	-	-	-	-	-	-	-
TATB	-	17	-	-	-	-	-	-	-	-
TNT	0.04	0.1	0.1	5	0.1	40	0.4	40	0.7	40
Ammonium nitrate	0.0	0.1	0.0	5	0.3	40	0.3	40	0.3	40

Table A-4. Stability Test Values of Explosives

Material	75°C international test, percent loss in weight	100°C Heat Test, percent loss in weight in-		Vacuum stability test						
		1 st 48 hr	2 nd 48 hr	Sample, gm	100°C		120°C		150°C	
					ML	HR	ML	HR	ML	HR
Binary										
50/50 Amatol	-	-	5		0.3	40	1.0	40		
Composition B	-	0.2	0.2	5	0.7	48	0.9	48	11 +	48
Composition C3	-	-	-		1.21	48	11 +	48		
Composition C4	-	0.13	0.0	-	0.20	40				
55/45 Ednatol	-	0.2	0.1	5	0.7	40	11 +	24	-	-
75/25 Octol	-	-	5	-	-		0.39	40	11	40
							to 0.65			
70/30 Octol to 0.76	-	-	-	5	-	-	0.37	40	5.10	40
50/50 Pentolite	-	0.0	0.2	5	2.5	40	11 +	16	-	
Picratol	0.0	0.0	0.05	5	0.4	40	0.7	40	0.7	40
70/30 Tetrytol	-	0.1	0.1	5	3.0	40	11 +	40		
80/20 Tritonal	-	-	-	5	0.1	40	0.2	40	0.8	40
Ternary										
HBX-1	-	0.058	0.0							
HBX-2	-	0.70	0.0							
Minol-2	-	-	-	5	0.0	48	2.1	40	-	-
Torpex	-	0.0	0.10	5	0.2	40	1.5	40	11 +	16

Table A-5. Density Values of Explosives in Grams Per Milliliter

Material	Crystal or liquid	Pressure in kilopascals (pounds per square inch)							Cast
		20,685 (3,00)	34,475 (5,000)	68,450 (10,000)	103,425 (15,000)	137,900 (20,000)	206,850 (30,000)	275,800 (40,000)	
Primary explosives									
Lead azide (pure)	4.87								
DLA	-	-	-	-	3.14	-	-	-	-
SLA	-	-	-	-	3.31	-	-	-	-
PVA-LA	-	-	-	-	3.81	-	-	-	-
Mercury fulminate	4.43	3.0	3.2	3.6	3.82	4.0	4.1	-	-
Diazodinitrophenol	1.63 to 1.65	1.14							
Lead styphnate (normal)	3.02								
Tetracene	1.7	1.05							
Aliphatic nitrate esters									
BTN		1.520	-	-	-	-	-	-	-
-									
DEGN	1.39	-	-	-	--	-	-	-	-
Nitroglycerin	1.596	-	-	-	-	-	-	-	-

Table A-5. Density Values of Explosives in Grams Per Milliliter (Cont)

Material	Crystal or liquid	Pressure in kilopascals (pounds per square inch)							Cast
		20,685 (3,00)	34,475 (5,000)	68,450 (10,000)	103,425 (15,000)	137,900 (20,000)	206,850 (30,000)	275,800 (40,000)	
PETN	1.778	1.37	1.575	1.638	-	1.71	1.725	1.74	-
TEGN	1.335	-	-	-	-	-	-	-	-
TMETN	1.47	-	-	-	-	-	-	-	-
Nitramines									
HMX	1.905	-	-	-	-	-	-	-	-
RDX	1.816	1.46	1.52	1.60	1.65	1.68	1.70	1.71	-
Haleite	1.66 to 1.77	-	1.28	1.38	1.44	1.49	-	-	-
Nitroguanidine	1.71	0.95	-	-	-	-	-	-	-
Tetryl	1.73	1.40	1.47	1.57	1.63	1.67	1.71	1.71	1.62
Nitroaromatics									
Ammonium picrate	1.717	1.33	1.41	1.47	1.51	1.53	1.56	1.57	-
HNAB	1.79	-	-	-	-	-	-	-	-
TNT 1.654	1.34	1.40	1.47	1.52	1.55	1.59	1.59	-	-
Ammonium nitrate	1.64 to 1.75	-	-	-	-	-	-	-	-
Binary									
Composition A3	-	1.47	-	-	-	-	-	-	-
Composition B	-	-	-	-	-	-	-	-	1.66
55/45 Ednatol	-	-	-	-	-	-	-	-	1.62
75/25 Octol	1.832 to 1.843	-	-	-	-	-	-	-	1.800
70/30 Octol	1.819 to 1.822	-	-	-	-	-	-	-	1.790
50/50 Pentolite	-	-	-	-	-	-	-	-	1.63 to 1.67
Picratol	-	-	-	-	-	-	-	-	1.62
70/30 Tetrytol	-	-	-	-	-	-	-	-	1.60
80/20 Tritonal	-	-	-	-	-	-	-	-	1.73
Ternary									
HBX-1	-	-	-	-	-	-	-	-	1.76
HBX-3	-	-	-	-	-	-	-	-	1.882
Minol-2	-	-	-	-	-	-	-	-	1.62 to 1.74
Torpex	-	-	-	-	-	-	-	-	1.82
Quaternary									
DBX -	-	-	-	-	-	-	-	-	1.61 to 1.74

Table A-6. Conversion Factors and Constants

Unit	Factor	Product
Inches	25.4	Millimeters
Millimeters	0.03937	Inches
Microns	0.001	Millimeters
Angstrom units	0.0000001	Millimeters
Square inches	645.16	Square millimeters
Square millimeters	0.00155	Square inches
Cubic inches	16.387	Milliliters
Milliliters	0.061025	Cubic inches
Cubic feet	0.028317	Cubic meters
Cubic feet	7.48	U.S. gallons
Cubic meters	35.315	Cubic feet
Liters	61.022	Cubic inches
Liters	0.264178	U.S. gallons
U.S. gallons	231.	Cubic inches
U.S. gallons	3.78533	Liters
U.S. gallons	8.337	Pounds water at 150C
Kilograms	2.2046	Pounds
Pounds	453.59	Grams
Ounce	28.35	Grams
Calories	4.1855	International joules
Calories	0.0413	Liter-atmospheres
Kilogram-calories	3.9685	BTU's
BTU's	0.25198	Kilogram-calories
BTU per cubic foot	890.	Kilogram calories per cubic meter
Kilograms per square centimeter	14.223	Pounds per square inch
Atmospheres	1033.3	Grams per square centimeter
Atmospheres	14.696	Pounds per square inch
Atmospheres	760.	Millimeters of mercury
Pounds per square inch	6.895	Kilopascals
Gram moles	22.414	Liters at 0°C and 760 mm of mercury
R (gas constant)	1.9684	Calories per °C per mole
Foot candles	1.	Lumens per square foot
Lumens	0.001496	Watts

Table A-7. Specifications¹

Material	Specification Number
Primary explosives	
Lead azide	MIL-L-3055
Special purpose lead azide	MIL-L-14758
RD1333 (lead azide)	MIL-L-46225
Mercury fulminate	JAN-M-219
Diazodinitrophenol	JAN-D-552
Lead styphnate, basic	MIL-L-16355
Lead styphnate, normal	MIL-L-757
Tetracene	MIL-T-46938
Potassium dinitrobenzofuroxane	MIL-P-50486
Lead mononitroresorcinate	MIL-L-46496
Aliphatic nitrate esters	
Butanetriol trinitrate	no specification
Diethyleneglycol dinitrate	no specification
Nitrocellulose	MIL-N-244
Nitroglycerin	MIL-N-246
Nitrostarch	no specification
PETN	MIL-P-387
TEGN	no specification
TMETN	no specification
Nitramines	
HMX	MIL-H-45444
RDX	MIL-R-398
EDDN	no specification
Haleite	no specification
NQ	MIL-N-494
Tetryl	MIL-T-339
Nitroaromatics	
Ammonium picrate	MIL-A-166
DATB	no specification
HNAB	no specification
HNS	no specification
TATB	no specification
TNT	MIL-T-248
Ammonium nitrate	MIL-A-50460
Binary	
Amatol	no specification
Composition A3	MIL-C-440
Composition A4	MIL-C-440
Composition A5	MIL-E-14970
Composition A6	MIL-C-60051
Composition B	MIL-C-401
Composition B3	MIL-C-45113
Composition B4	MIL-C-46652
Cyclotol	MIL-C-13477
Composition CH6	MIL-C-21723

Table A-7. Specifications¹

Material	Specification Number
Ednatol	no specification
Octol	MIL-0-45445
Pentolite (50/50)	JAN-P-408
Picratols	no specification
Tetrytols	no specification
Tritonal	no specification
Ternary	
Amatex	no specification
Ammonal	no specification
H6	MIL-E-22267
HBX	MIL-E-22267
HTA-3	no specification
Minol-2	MIL-M-14745
Torpex	no specification
PBX	
Military specifications	
LX-14-0	MIL-H-48358
PBX Type 1	MIL-P-14999
PBX Type 2	
PBX 0280	MIL-R-48878
PBX 9010	MIL-P-45447
PBX 9407	MIL-R-63419
PBXN-203	MIL-E-85113
PBXN-4	MIL-P-23625
PBXN-5	MIL-E-81111
Navy specifications (ternary category)	
PBXN-3	OS-11641
PBXN-6	WS-12604
PBXN-101	WS-3829
PBXN-102	WS-3823
PBXN-103	OS-12800D
PBXN-104	WS-11511
PBXN-201	WS-1 1498
PBXN-301	WS-12612
Dept. of energy specifications (Lawrence Livermore Laboratory [LLNL])	
LX-04	RM 252353
LX-07	RM 253379
LX-09	RM 253200
LX-10	RM 253511
LX-13	RM 253520

¹Currently, because of worker exposure hazards, benzene is being replaced by other solvents in all specifications.

Table A-8. Hazardous Component Safety Data Sheet (HCSDS) Numbers

Material	Sheet Number
Amatex	00920
Amatol	00774
Ammonium nitrate	00252
Ammonium picrate	00905
Black powder	00020
Colored smoke (green, yellow, red, violet)	20016
Composition A3	00150
Composition A4	00311
Composition A5	00546
Composition A7	00910
Composition B	00101, 01276, 01277
Composition B4	00151
Composition B5	00413
Composition C4	00077
Composition CH6	00628
Composition H6	00829
Composition HTA-3	00630
DATB	01194
Diazodinitrophenol	40066
Dinitrotoluene	00439
Lead azide (CLA and PVA-LA)	00066
Lead azide RD1333	00128
LX14	01043
Military dynamite	00147
Nitrocellulose	00031
Nitroglycerin	00030
Nitroguanidine	00491
Nitrostarch	40067
Octol	00154
PBXN4	01195
PBXN5	00622
PBXN6	00994
50/50 Pentolite	00253
PETN	00087
Propellant M1	00447
Propellant M2	00807
Propellant M5	00317
Propellant M6	00371
Propellant M7	00221
Propellant M8	00238
Propellant M9	00035
Propellant M10	00601
Propellant M15	00822
Propellant M17	00823
Propellant M30	00318
Pyroxlyn	00860
Tetryl	00116
TMETN	01193
80/20 Tritonal	00479

APPENDIX B

BIBLIOGRAPHY

-
- Army Material Command Pamphlet (AMCP) 706-180: (Engineering Design Handbook) *Principles of Explosive Behavior*. Washington, DC: Headquarters, US Army Material Command, 1972.
- Army Material Command Pamphlet (AMCP) 706-185: (Engineering Design Handbook) *Military Pyrotechnics: Part One, Theory and Application*. Washington DC: Headquarters, US Army Material Command, 1967.
- Army Material Command Pamphlet (AMCP) 706-186: (Engineering Design Handbook) *Military Pyrotechnics: Part Two, Safety, Procedures, and Glossary*. Washington, DC: Headquarters, US Army Material Command, 1963.
- Army Material Command Pamphlet (AMCP) 706-188: (Engineering Design Handbook) *Military Pyrotechnics: Part Four, Design of Ammunition of Pyrotechnic Effect*. Washington, DC: Headquarters, US Army Material Command, 1974.
- Brophy, Leo T., Wyndham D. Miles, and Rexmon Cochrane *The Chemical Warfare Service, From Laboratory to Field*. US Army in World War II. Washington, DC: Office of Chief of Military History, Department of the Army, 1959.
- Canby, Courtlandt. *A History of Weaponry*. New York: Hawthorne Books, Inc, 1963.
- Davis, T.L. *Chemistry of Powder and Explosives*. New York, 1943.
- DARCOM Regulation 385-100. Alexandria, Virginia *US Army Material Development and Readiness Command*, 1981.
- Dobratz, B.M. *LLNL Explosives Handbook: Properties of Chemical Explosives and Explosive Stimulants*. Springfield, Virginia: National Technical Information Service (US Department of Commerce), 1981.
- Faber, Henry B. *The History and Development of Military Pyrotechnics*. Military Pyrotechnics, vol I. Washington, DC: Government Printing Office, 1919.
- Fair, H. and R. Walker, ed. *Energetic Materials*. Technology of the Inorganic Azides, vol 2. New York: Plenum Press, 1977.
- Green, Constance M., Harry C. Thompson, and Peter C. Roots *The Ordnance Department, Planning Munitions for War*. US Army in World War II. Washington, DC: Office of Chief of Military History, Department of the Army, 1955.
- Hermes, Walter G. *US Army in the Korean War, Truce Tent and Fighting Front*. Washington, DC: Office of the Chief of Military History, Department of the Army, 1966.
- Joint Service Safety and Performance Manual for Qualification of Explosives for Military Use*. Army Research and Development Command (ARRADCOM), 1972.
- LASL Explosive Property Data*. T. Gibbs and A. Popolato, editors, Berkeley: University of California Press, 1980.
- Linder, V. *Explosives and Propellants*. Encyclopedia of Chemical Technology, Third Edition, vol 9. New York: John Wiley and Sons, 1980.
- McLain, J.H. *Pyrotechnics*. Philadelphia: Franklin Institute Press, 1980.
- Meyer, R. *Explosives*. Verlag Chemie, Weinheim, New York, 1977.
- Military Chemistry and Chemical Compounds*, FM 3-9/AFR 3557, 30 October, 1975.
- Mitchell, William A. *World's Military History*. Harrisburg, PA: Military Service Publishing Co., 1935 (1921).

- Partington, J.R. *A History of Greek Fire and Gunpowder*. Cambridge, England: W. Heffer and Sons, LTD, 1960.
- Pollard, F.B. and J.H. Arnold, ed. *Aerospace Ordnance Handbook*. Englewood Cliffs, New Jersey: Prentiss Hall, 1966.
- Prentiss, Agustin M. *Chemicals in War*. York, Pa: McGraw-Hill, Maple Press, 1937.
- Priester, F. *Explosives*. Encyclopedia of Industrial Chemical Analysis, vol 12. New York: John Wiley and Sons, 1971.
- Stiefel, Ludwig. *GunPropellants*. Progress in Astronautics and Aeronautics, vol 66, 1978.
- The Encyclopedia of Explosives and Related Items*. Springfield, Virginia: National Technical Information Service (US Department of Commerce), 1960-1982.
- Thompson, Harry C. and Lida Mayo. *The Ordnance Department, Procurement and Supply*. US Army in World War II. Washington, DC: Office of Chief of Military History, Department of the Army, 1956.
- Wells, H.G. *The Outline of History*. New York: The Macmillan Co., 1923 (1920).
- Yinon, J. and S. Zitrin. *The Analysis of Explosives*. Peragamon Series in Analytical Chemistry, vol 3. New York: Peragamon Press, 1981.

INDEX

	<i>Paragraph</i>	<i>Page</i>
Adiabatic sensitivity test.....	5-19	5-9
Atocite.....	11-4	11-5
Air transportation of explosives and ammunition.....	14-5	14-14
Akardits	9-12	9-11
Akatsuki.....	11-5	11-9
Akvanity.....	11-6	11-10
Akvatoly.....	11-6	11-11
Aldofit	11-9	11-16
Aliphatic nitrate esters.....	8-2	8-1
Aluminized explosives (see ammonal)		
Alyumatoly.....	11-6	11-11
Alyumit No.....	11-6	11-11
Alyumotol.....	11-6	11-11
Amatex 20		
Brisance.....	8-6	8-124
Characteristics.....	8-6	8-124
Destruction	5-3	15-1
Packing.....	14-2	14-1
Sensitivity	8-6	8-124
Shipment.....	14-5	14-10
Stability	8-6	8-124
Amatol		
Brisance	8-6	8-98
Characteristics.....	8-6	8-97
Destruction	15-3	15-1
Manufacture	8-6	8-98
Packing.....	14-2	14-1
Reactivity	8-6	8-98
Sensitivity	8-6	8-98
Shipment.....	14-5	14-10
Stability	8-6	8-98
Toxicity	12-2	12-3
Amatolo.....	11-4	11-5
Amatolos	11-7	11-13
Amatol, Russian.....	11-6	11-11
Ammoksily.....	11-6	11-11
Ammonaftite	11-4	11-5
Ammonal, Italian	11-4	11-5
Ammonal		
Brisance.....	8-6	8-124
Characteristics	8-6	8-124
Destruction	15-3	15-1
Manufacture	8-6	8-124
Packing.....	14-2	14-1
Reactivity	8-6	8-125
Sensitivity	8-6	8-125
Shipment	14-5	14-10
Stability	8-6	8-125
Ammonaly.....	11-6	11-11
Ammonaru.....	11-5	11-9
Ammongelatin dynamit.....	11-8	11-15

	<i>Paragraph</i>	<i>Page</i>
Ammoniakkрут.....	11-8	11-15
Ammonit.....	11-6	11-11
Ammonit predokhranitelni.....	11-6	11-11
Ammonit V-3V poroshke.....	11-6	11-11
Ammonite No.....	11-4	11-5
Ammonity.....	11-6	11-11
Ammonium nitrate		
Brisance.....	8-5	8-95
Characteristics.....	8-5	8-92
Destruction.....	15-3	15-1
History.....	2-5	2-4
Manufacture.....	8-5	8-94
Packing.....	14-2	14-1
Reactivity.....	8-5	8-93
Sensitivity.....	8-5	8-95
Shipment.....	14-5	14-10
Specification.....	8-5	8-94
Stability.....	8-5	8-95
Ammonium nitrate fuel oil explosives.....	8-6	8-135
Water gel explosives.....	8-6	8-135
Slurry explosives.....	8-6	8-135
Incendiaries.....	2-7	2-1, 2-10
Ammonium picrate		
Brisance.....	8-4	8-59
Characteristics.....	8-4	8-55
Destruction.....	15-3	15-1
History.....	2-7	2-5
Manufacture.....	8-4	8-57
Packing.....	14-2	14-1
Reactivity.....	8-4	8-57
Sensitivity.....	8-4	8-58
Shipment.....	14-5	14-10
Specification.....	8-4	8-58
Stability.....	8-4	8-59
Toxicity.....	12-2	12-3
Ammonpentrit.....	11-9-	9-16
Ammontol.....	11-6	11-12
Amolit.....	11-9	11-17
Amonales.....	11-7	11-13
Amonitas.....	1-7	11-13
Amylace.....	11-2	11-2
Anagon.....	11-7	11-13
ANFO (see ammonium nitrate fuel oil explosives)		
Antigrison.....	11-4	11-5
Antigrisouteux.....	11-2	11-4
Antigrisu explosives.....	11-7	11-13
AT 11-6.....	11-10	
Autonile.....	11-4	11-5
A-IX-2.....	11-6	11-10
Ball propellant manufacturing.....	9-5	9-4
Ballistic mortar test.....	3-5	3-4
Ballistic pendulum test.....	3-5	3-4
Baratol.....	11-7	11-13
Becker-Kistiakowsky-Wilson equation of state.....	4-5	4-10

	<i>Paragraph</i>	<i>Page</i>
Belity	11-6	11-12
Binding agents, pyrotechnic	10-1	10-2
Black powder	2-3	2-2
Black powder, destruction of	15-3	15-7
BLAKE code	9-3	9-3
Blast effects	4-6	4-11
Blastin	11-8	11-15
BM	11-4	11-5
Bonit	11-8	11-15
Bonocord	11-8	11-15
Booster	3-4	3-1
Brisance, definition.....	3-3-5	3-4
BTN (see butanetriol trinitrate)		
Burning rate	3-2, 9-7	3-1, 9-6
Burning, theory of.....	3-2	3-1
Bursting charge	3-4	3-2
Buryi shokoladnyi porakh.....	11-6	11-12
Butanetriol trinitrate		
Brisance	8-2	8-1
Characteristics	8-2	8-1
Destruction	15-3	15-1
History	2-6	2-7
Manufacture	8-2	8-1
Packing	14-2	14-1
Reactivity	8-2	8-1
Sensitivity	8-2	8-1
Shipment	14-5	14-10
Stability	8-2	8-1
Cap test	6-10	6-2
Card gap test	6-9	6-2
Centralite	9-12	9-11
Chapman-Jouquet theory.....	4-5	4-5 4-9
Charnyi porokh.....	11-6	11-12
Chauyaku.....	11-5	11-9
Chemical destruction of energetic material.....	15-4	15-8
Chetah codes	9-3	9-3
Chromatography	13-3	13-4
CLA (see lead azide)		
Classical chemical analysis.....	10-3	10-36
Closed bomb apparatus.....	2-5	2-4
Closed bomb test, propellants.....	6-7	6-1
Collection of explosive dust.....	15-5	15-10
Collection of waste.....	15-5	15-9
Collodion (see nitrocellulose)		
Color intensifiers	10-1	10-1
Colored smoke	3-4, 10-1	3-3, 10-6
Compatibility, propellants.....	6-2	6-1
Composite propellant		
Definition	3-4	3-3
Manufacturing	9-5	9-4

	<i>Paragraph</i>	<i>Page</i>
Composition A		
Brisance	8-6	8-100
Characteristics.....	8-6	8-100
Destruction	15-3	15-1
Manufacture	8-6	8-100
Packing.....	14-2	14-1
Sensitivity	8-6	8-100
Shipment	14-5	14-10
Stability	8-6	8-101
Composition B		
Brisance	8-6	8-106
Characteristics.....	8-6	8-105
Destruction	15-3	15-1
Manufacture	8-6	8-105
Packing	14-2	14-1
Reactivity	8-6	8-105
Sensitivity	8-6	8-105
Shipment.....	14-5	14-10
Stability	8-6	8-106
Composition C		
Brisance	8-6	8-111
Characteristics	8-6	8-109
Destruction	15-3	15-1
History	15-3	15-3
Manufacture.....	8-6	8-111
Packing.....	14-2	14-1
Reactivity.....	8-6	8-111
Sensitivity	8-6	8-109,
.....		8-111
Shipment	14-5	14-10
Specification.....	8-6	8-109,
.....		8-110
Stability	8-6	8-110,
.....		8-111
Composition CH6		
Brisance	8-6	8-111
Characteristics	8-6	8-111
Destruction	15-3	15-1
Packing.....	14-2	14-1
Sensitivity	8-6	8-111
Shipment	14-5	14-10
Computer programs		
Detonation.....	4-5	4-10
Interior ballistics	9-10	9-8
Propellants	9-3	9-2
Cook-off temperature test.....	5-6	5-5
Corning of black powder.....	2-5	2-3
Couche	11-2	11-3
Covolume.....	9-3	9-2
CSE	11-2	11-3
Cyclotetramethylenetetranitramine		
Brisance.....	8-3	8-30
Characteristics.....	8-3	8-27
Destruction	15-3	15-1

	<i>Paragraph</i>	<i>Page</i>
Cyclotetramethylenetetranitramine (Cont)		
Manufacture.....	8-3	8-29
Packing.....	14-2	14-1
Reactivity	8-3	8-30
Sensitivity	8-3	8-30
Shipment.....	14-5	14-10
Specification.....	8-3	8-29
Stability	8-3	8-30
Toxicity	12-2	12-1
Cyclotrimethylenetrinitramine		
Brisance	8-3	8-35
Characteristics	8-3	8-30
Destruction	15-3	15-1
History	2-6, 2-8	2-8, 2-14
Manufacture	8-3	8-34
Packing	14-2	14-1
Reactivity	8-3	8-33
Sensitivity	8-3	8-34
Shipment.....	14-5	14-10
Specification.....	8-3	8-37
Stability	8-3	8-35
Toxicity	12-2	12-1
Cylinder expansion test.....	5-21	5-9
Dainamaito.....	11-5	11-10
DATB (see diamino-trinitrobenzene)		
DBX (see depth bomb explosive)		
DCLA (see lead azide)		
DDNP (see diazodinitrophenol)		
Decontamination	15-5	15-28
Deflagration	3-2, 4-3	3-1, 4-1
Deflagration to detonation transition propellant.....	6-4	6-1
Deflagration to detonation transfer.....	4-4	4-2
DEGN (see diethyleneglycol dinitrate)		
Delays	3-4, 10-1	3-3, 10-15
Demilitarization	15-6	15-12
Depth bomb explosive		
Brisance	8-6	8-129
Characteristics	8-6	8-129
Destruction	15-3	15-1
Manufacture	8-6	8-129
Packing	14-2	14-1
Sensitivity	8-6	8-129
Shipment.....	14-5	14-10
Stability	8-6	8-129
Toxicity	12-2	12-3
deSaint Roberts equation	9-7	9-6
Destruction by burning and detonation.....	15-3	15-1
Destruction of waste.....	15-5	15-8
Detection, hidden explosives.....	3-7	13-11
Detection, residues.....	13-6	13-10
Deterrent	9-7	9-7
Detonation	3-2, 4-5	3-1, 4-3
Detonation velocity		
Definition	3-5	3-4
Test	5-5	5-3
Detonierende zundschnur.....	1-9	11-17
Detoniy.....	11-6	11-12

	<i>Paragraph</i>	<i>Page</i>
Development tests, pyrotechnic.....	10-3	10-24
Diamino-trinitrobenzene		
Brisance	8-4	8-62
Characteristics.....	8-4	8-61
Destruction	15-3	15-1
Manufacture	8-4	8-61
Packing	14-2	14-1
Sensitivity	8-4	8-62
Shipment.....	14-5	14-10
Stability	8-4	8-62
Diamon.....	11-4	11-6
Diamon 1B	11-4	11-6
Diazodinitrophenol		
Brisance	7-4	7-10
Characteristics	7-4	7-9 i
Destruction	15-3	15-1
History	2-8	2-12
Manufacture	7-4	7-9
Packing	14-2	14-1
Reactivity	7-4	7-9
Sensitivity	7-4	7-10
Shipment	14-5	14-10
Specification.....	7-4	7-10
Stability	7-4	7-11
Diethyleneglycol dinitrate		
Brisance	8-2	8-2
Characteristics.....	8-2	8-1
Destruction	15-3	15-1
History	2-8	2-13
Manufacture	8-2	8-1
Packing	14-2	14-1
Reactivity	8-2	8-2
Sensitivity	8-2	8-2
Shipment.....	14-5	14-10
Stability	8-2	8-2
Differential thermal analysis.....	3-5, 10-3	3-5, 10-35
Digressive grain.....	9-6	9-5
Dinaftalit.....	11-6	11-12
Dinamitas.....	11-7	11-14
Dinamity.....	11-6	11-12
Dinamones	11-7	11-14
Dinitronaftalin	11-6	11-12
Diphenylamine	2-7., 9-12	2-9, 9-28
Disposal	15-2	15-1
DLA (see lead azide)		
Donarita.....	11-7	11-14
Double-base propellant.....	3-4, 9-2,	3-2, 9-5,
.....	9-5	9-4
DPA (see diphenylamine)		
Dynamic burning.....	9-7	9-7
Dynamite	2-6, 8-6	2-6, 8-304
Dynamite, destruction of.....	15-3	15-7
Dynamite, Italian	11-4	11-5

	<i>Paragraph</i>	<i>Page</i>
EDDN (see ethylenediamine dinitrate)		
Ednatols		
Brisance	8-6	8-112
Characteristics	8-6	8-112
Destruction	15-3	15-1
Manufacture	8-6	8-112
Packing	14-2	14-1
Sensitivity	8-6	8-112
Shipment	14-5	1410
Stability	8-6	8-112
Electrical primers	7-9	7-19
Electron spin resonance	13-5	13-9
Electrostatic discharge sensitivity test, propellants	11	6-2
Electrostatic sensitivity	3-5	3-4
Electrostatic sensitivity, explosives	5-4	5-3
Equation of the form	9-10	9-8
Explosion temperature test	6-17	6-3
Erosive burning	9-7	9-7
Esplosivi da mina	11-4	11-6
Esplosivi di primari	11-4	11-8
Esplosivi di rinfargo	11-4	11-8
Esplosivi di scoppio	11-4	11-8
Esplosivi plastico	11-4	11-8
Esplosivi S20	11-4	11-8
ESR (see electron spin resonance)		
Ethyl centralite	9-12	9-11
Ethylenediamine dinitrate		
Brisance	8-3	8-38
Characteristics	8-3	8-38
Destruction	15-3	15-1
Manufacture	8-3	8-38
Packing	14-2	14-1
Reactivity	8-3	8-38
Sensitivity	8-3	8-38
Shipment	14-5	14-10
Stability	8-3	8-38
Ethylenedinitramine		
Brisance	8-3	8-41
Characteristics	8-3	8-39
Destruction	15-3	15-1
History	2-8	2-13
Manufacture	8-3	8-39
Packing	14-2	14-1
Reactivity	8-3	8-39
Sensitivity	8-3	8-40
Shipment	14-5	14-10
Specification	8-3	8-40
Stability	8-3	8-41
Evaluation tests, pyrotechnic	10-3	10-25
Explosif amylace	11-2	11-1
Explosif D	11-2	11-4
Explosifs antigrisouteux	11-2	11-1
Explosifs chlorates	11-2	11-2
Explosifs couche	11-2	11-3

	<i>Paragraph</i>	<i>Page</i>
Explosifs CSE.....	11-2	11-3
Explosifs et poudres.....	11-2	11-4
Explosifs roche.....	11-2	11-4
Explosive D (see ammonium picrate)		
Explosive train.....	3-4	3-1
Explosives doratado.....	11-7	11-14
Explosives, general requirements.....	5-1	5-1
Explosivo plastico "LaMaranosa".....	11-7	11-14
External heat test, propellants.....	6-3	6-1
Fireworks.....	2-3	2-2
Flares.....	2-7, 3-4,	2-11, 3-6,
.....	10-1	10-3
Flying plate test.....	5-9	5-7
Forty foot drop test.....	5-14	5-8
Fragmentation test.....	5-20	5-9
French energetic material.....	11-2	11-1
Friction sensitivity.....	5-7	5-5
Friction sensitivity test, propellants.....	6-12	6-2
Fuels, pyrotechnic.....	10-1	10-1
Fulminating gold.....	2-5	2-3
Fumers.....	3-4, 10-1	3-3, 10-11
Fuses.....	3-4, 10-1	3-3, 10-15
Gap tests.....	5-8	5-7
Gas chromatography.....	13-3	13-5
Gas operated pyrotechnic devices.....	10-3	10-12
Gelatine - cheddar.....	11-9	11-17
Gelatine - penthritins.....	11-9	11-17
Gelatinerad dynamit.....	11-8	11-15
German energetic material.....	11-3	11-4
GLC (see gas chromatography)		
Grammonal.....	11-6	11-12
Granulity.....	11-6	11-12
Grisou dynamite.....	11-4	11-8
Grisounite.....	11-4	11-8
Grisounite gomma.....	11-4	11-8
Grisounite roccia.....	11-4	11-8
Growth and exudation test.....	5-15	5-8
GSC (see gas chromatography)		
Guncotton (see nitrocellulose)		
Gunpowder.....	2-4	2-2
Haleite (see ethylenedinitraminea)		
HBX-1 (see high blast explosives)		
HBX-2 (see high blast explosives)		
Heat of combustion.....	3-5	3-3
Heat of detonation.....	3-5	3-3
Heat of fusion.....	3-5	3-3
Heat of sublimation.....	3-5	3-3
Heat of vaporization.....	3-5	3-3
Heat tests, 100° and 750C.....	3-5	3-5
Heat tests, propellants, 134.5° and 120°C.....	6-5	6-1
Hexal.....	11-9	11-17
Hexaliti.....	11-4	11-8

	<i>Paragraph</i>	<i>Page</i>
Hexanitroazobenzene		
Brisance.....	8-4	8-62
Characteristics	8-4	8-62
Destruction	15-3	15-1
Manufacture.....	8-4	8-62
Packing.....	14-2	14-1
Sensitivity.....	8-4	8-62
Shipment.....	14-5	14-10
Stability.....	8-4	8-62
Hexanitrostilbene		
Brisance.....	8-4	8-65
Characteristics	8-4	8-62
Destruction	15-3	15-1
Manufacture.....	8-4	8-65
Packing.....	14-2	14-1
Sensitivity.....	8-4	8-65
Shipment.....	14-5	14-10
Stability.....	8-4	8-66
Hexogeno plastico.....	11-7	11-14
Hexocire	11-4	11-8
Hexocire-aluminum.....	11-4	11-8
Hexonitas.....	11-7	11-14
Hexonite.....	11-9	11-17
Hexotol.....	11-8	11-15
Hexotonal.....	11-8	11-15
High blast explosives		
Brisance.....	8-6	8-125
Characteristics.....	8-6	8-125
Destruction	15-3	1-1
Manufacture.....	8-6	8-126
Packing.....	14-2	14-1
Sensitivity.....	8-6	8-125
Shipment.....	14-5	14-10
Stability.....	8-6	8-125
High loading rate compression test.....	6-14	6-2
High performance liquid chromatography.....	13-3	13-6
HMX (see cyclotetramethylenetetranitramine)		
HNAB (see hexanitroazobenzene)		
HNS (see hexanitrostilbene)		
Hot spots.....	4-2	4-1
HPLC (see high performance liquid chromatography)		
HTA-3		
Brisance.....	8-6 8	8-126
Characteristics.....	8-6	8-126
Destruction	1-3	15-1
Manufacture.....	8-6	8-126
Packing.....	14-2	14-1
Sensitivity.....	8-6	8-126
Shipment.....	14-5	14-10
Stability.....	8-6	8-126
Hugoniot equation.....	4-5	4-6
H-6 (see high blast explosives)		

	<i>Paragraph</i>	<i>Page</i>
IBIS	9-10	9-10
Identification, residues.....	13-6	13-10
Igdanit.....	11-6	11-13
Ignitability.....	9-8	9-7
Ignitability test, propellants.....	6-17	6-3
Igniters	3-4, 10-1	3-2, 10-17
Ignition	4-2 4-1	
Ignition train	3-4 3-2	
Illuminance, pyrotechnic.....	10-1	10-2
Illustrations		
3-1. Explosive train		3-2
3-2. Ignition train		3-2
4-1. Shock wave formation.....		4-4
4-2. Steady plane shock front.....		4-5
4-3. Control volume or mass passing through a shock front.....		4-5
4-4. Shock properties in the x-t plane.....		4-8
4-5. Shock properties in the P-u plane.....		4-8
4-6. Shock properties in the P-V, plane.....		4-9
4-7. Detonation wave.....		4-9
4-8. P-Vs plot during detonation.....		4-10
4-9. Typical pressure-time record for the blast from a bomb.....		4-12
4-10. Mach reflection of blast wave.....		4-14
4-11. Shaped charge and target.....		4-15
4-12. Shaped charge jet formation.....		4-16
4-13. Shaped charge penetration.....		4-16
5-1. Vacuum stability test.....		5-2
5-2. Anvil striker arrangement, ERL machine.....		5-3
5-3. Drop weight impact machine, ERL type, type 12 tools.....		5-3
5-4. Picatinny Arsenal impact test apparatus.....		5-4
5-5. Parts of Picatinny Arsenal test apparatus.....		5-5
5-6. Bureau of Mines impact test apparatus.....		5-6
5-7. Scaled drawing of the SUSAN projectile.....		5-9
6-1. 900C Dutch weight loss test results.....		6-3
7-1. Structural formula for lead azide.....		7-1
7-2. DTA curve for lead azide.....		7-6
7-3. Structural formula for DDNP.....		7-9
7-4. Preparation of DDNP		7-10
7-5. Basic lead styphnate.....		7-12
7-6. Normal lead styphnate.....		7-12
7-7. DTA curve for lead styphnate.....		7-14
7-8. TGA curve for lead styphnate.....		7-15
7-9. Structural formula for tetracene.....		7-15
7-10. Structural formula for KDNBF.....		7-17
7-11. Structural formula for LMNR.....		7-17
8-1. Structural formula for BTN.....		8-1
8-2. Structural formula for DEGN.....		8-1
8-3. Cellulose.....		8-3
8-4. Nitration of cellulose.....		8-5
8-5. DTA curve for nitrocellulose.....		8-8
8-6. Structural formula for nitroglycerin.....		8-9
8-7. Schmid-Meissner continuous method for manufacturing nitroglycerin.....		8-11

	<i>Paragraph</i>	<i>Page</i>
Illustrations (Cont)		
8-8. Biazzì continuous method for manufacturing nitroglycerin.....		8-13
8-9. Structural formula of PETN.....		8-16
8-10. Thermal decomposition of PETN.....		8-23
8-11. DTA curve for PETN.....		8-24
8-12. TGA curve for PETN.....		8-25
8-13. Structural formula for TEGN.....		8-25
8-14. Structural formula for TMETN.....		8-26
8-15. Structural formula for HMX.....		8-27
8-16. DTA curve for HMX.....		8-31
8-17. TGA curve for HMX.....		8-32
8-18. Structural formula for RDX.....		8-32
8-19. DTA curve for RDX.....		8-36
8-20. TGA curve for RDX.....		8-37
8-21. Structural formula for EDDN.....		8-38
8-22. Structural formula for Haleite.....		8-39
8-23. Production of ethyleneurea.....		8-40
8-24. Boiling of dinitroethyleneurea.....		8-41
8-25. Production of Haleite.....		8-41
8-26. Structural formula for nitroguanidine.....		8-43
8-27. DTA curve for nitroguanidine.....		8-46
8-28. TGA curve for nitroguanidine.....		8-47
8-29. Structural formula for tetryl.....		8-47
8-30. Trinitrophenyl methylamine.....		8-48
8-31. Hydrolysis of tetryl.....		8-48
8-32. Reaction of tetryl with aniline.....		8-49
8-33. Homologs and analogs of tetryl.....		8-49
8-34. Nitration and hydrolysis of tetryl.....		8-50
8-35. Benzidine derivatives during tetryl manufacture.....		8-51
8-36. Deflagration to detonation transfer apparatus.....		8-53
8-37. Effects of compaction on predetonation column length in tetryl.....		8-54
8-38. Kinetic gas-evolution curves in the decomposition of tetryl.....		8-54
8-39. DTA curve for tetryl.....		8-56
8-40. TGA curve for tetryl.....		8-57
8-41. Structural formula for ammonium picrate.....		8-57
8-42. DTA curve for ammonium picrate.....		8-60
8-43. Structural formula for DATB.....		8-61
8-44. DTA curve for DATB.....		8-63
8-45. Structural formula for HNAB.....		8-64
8-46. DTA curve for HNAB.....		8-64
8-47. Structural formula for HNS.....		8-65
8-48. DTA curve for HNS.....		8-68
8-49. TGA curve for HNS.....		8-69
8-50. Structural formula for TATB.....		8-69
8-51. Configuration of TATB molecule.....		8-69
8-52. SUSAN test results for TATB.....		8-72
8-53. DTA curve for TATB.....		8-73
8-54. Structural formula for TNT.....		8-75
8-55. White compound.....		8-78
8-56. TNT and 2,4,5-TNT reaction.....		8-78
8-57. Reaction of TNT with nitrosylchloride.....		8-79
8-58. Reaction between TNT and phthalic anhydride.....		8-79
8-59. Reduction of TNT with sodium borohydride.....		8-79

	<i>Paragraph</i>	<i>Page</i>
Illustrations (Cont)		
8-60. Seven member ring structure.....		8-80
8-61. Reaction of TNT with hydrogen.....		8-80
8-62. Production of TATB from TNT.....		8-80
8-63. Reaction of TNT with bases.....		8-81
8-64. Reaction of TNT with potassium hydroxide.....		8-81
8-65. Reaction of TNT with phenylhydrazine.....		8-82
8-66. Agitation versus MNT yield.....		8-84
8-67. SUSAN test results for TNT.....		8-88
8-68. DTA curve for TNT.....		8-90
8-69. TGA curve for TNT.....		8-91
8-70. 4,6-Dinitroanthronil.....		8-91
8-71. Explosive coke azoxy compound.....		8-91
8-72. Photoexcitation of TNT.....		8-92
8-73. Structural formula for ammonium nitrate.....		8-93
8-74. DTA curve for ammonium nitrate.....		8-96
8-75. TGA curve for ammonium nitrate.....		8-97
8-76. DTA curve for 80/20 amatol.....		8-99
8-77. DTA curve for composition A.....		8-101
8-78. DTA curve for composition A3.....		8-102
8-79. SUSAN test results for composition B3.....		8-106
8-80. SUSAN test results for 75/25 cyclotol.....		8-106
8-81. DTA curve for composition B.....		8-107
8-82. DTA curve for 75/25 cyclotol.....		8-108
8-83. TGA curve for composition B.....		8-109
8-84. DTA curve for composition C3.....		8-110
8-85. SUSAN test results for LX-14.....		8-113
8-86. DTA curve for LX- 14.....		8-113
8-87. SUSAN test results for 75/25 octol.....		8-117
8-88. DTA curve for 75/25 octol.....		8-118
8-89. DTA curve for pentolite.....		8-120
8-90. DTA curve for H6.....		8-127
8-91. Injection molding process.....		8-131
8-92. DTA curve for PBXN-5.....		8-132
9-1. Typical shapes of propellant grains.....		9-5
9-2. Web thickness and direction of burning through a progressively burning grain.....		9-6
9-3. Pressure travel curves for a projectile in a gun.....		9-9
9-4. Akardits.....		9-12
12-1 Deleted.....		
12-2. Deleted.....		
12-3. Deleted.....		
13-1. Gas chromatograph output.....		13-6
14-1. Steel box for packing solid propellants, including marking.....		14-1
14-2. Metal lined wood box for packing solid propellants. including markings.....		14-2
14-3. Metal containers for propelling charges, including marking.....		14-3
14-4. Palletized large caliber high explosive projectiles, including marking.....		14-3
14-5. Palletized wood boxes containing explosives.....		14-4
14-6. Carton for packing high explosives, including marking.....		14-4
14-7. Wood box for packing high explosives, including marking.....		14-5

	<i>Paragraph</i>	<i>Page</i>
Impact sensitivity	3-5	3-4
Impact sensitivity test:		
Explosives	5-3	5-2
Propellants	6-13	6-2
Impetus	9-10	9-10
Impulse, blast	4-6	4-12
Incendiaries	3-4,10-1	3-3,10-4
Infrared spectroscopy.....	13-5	13-8
Infrared spectroscopy, pyrotechnics.....	10-4	10-12
Initiating explosives, destruction of.....	15-3	15-7
Initiation	4-2	4-1
Initiator	3-4, 1-1	3-2, 10-6
Interior ballistics	9-10	9-8
Italian dynamites.....	11-4	11-5
Italian energetic material.....	11-4	11-4
Japanese energetic materials.....	11-5	11-9
Jolt test	5-12	5-7
Jurrmbles test	5-13	5-7
Jump equations.....	4-5	4-6
KDNBF (see potassium dinitrobenzofuroxane)		
Ki (potassium iodide) test.....	3-5	3-5
Kokushokuyaku.....	11-5	11-9
LANL large scale gap test.....	5-8	5-7
LANL small scale gap test.....	5-8	5-7
Lead azide		
Brisance	7-2	7-5
Characteristics	7-2	7-1
Destruction	15-4	15-8
History	2-7	2-9
Manufacture	7-2	7-3
Packing	14-2	14-1
Sensitivity	7-2	7-4
Shipment	14-5	14-10
Specification	7-2	7-4
Stability	7-2	7-5
Toxicity	12-2	12-1
Types	7-2	7-3
Lead mononitroresorcinate		
Characteristics.....	7-8	7-1,7
Destruction	15-3	15-1
Manufacture.....	7-8	7-18
Packing	14-2	14-1
Shipment	14-5	14-10
Specification.....	7-8	7-18
Lead styphnate		
Brisance.....	7-5	7-13
Characteristics.....	7-5	7-11
Destruction	15-3	15-1
History	2-7	2-9
Manufacture.....	7-5	7-12
Packing	14-2	14-1
Reactivity	7-5	7-1
Sensitivity.....	7-5	7-13
Shipment	1 4-5	14-10
Specification.....	7-5	7-12, 7-13
Stability.....	7-5	7-13
Types	7-5	7-1

	<i>Paragraph</i>	<i>Page</i>
Liquid chromatography.....	13-3	13-4
LLNL reactivity test.....	3-5	3-5
LMNR (see lead mononitroresorcinate)		
Low loading rate compression test.....	6-15	6-2
LX-14		
Characteristics.....	8-6	8-112
Destruction.....	15-3	15-1
Packing.....	14-2	14-1
Sensitivity.....	8-6	8-112
Shipment.....	14-5	14-10
Mach reflection.....	4-6	4-13
Magazine operational regulations.....	14-4	14-7
Magazine temperature control.....	14-4	14-7
.....	14-4	14-6
Magnetic resonance.....	13-5	13-9
Malfunction tests, pyrotechnic.....	10-3	10-9
Mansit.....	11-6	11-13
Manufacturing, pyrotechnics.....	10-2	10-8
Marking.....	14-3	14-6
Mass spectrometry.....	13-5	13-10
MAT.....	11-4	11-8
Matter explosives.....	11-9	11-17
Mercury fulminate		
Brisance.....	7-3	7-8
Characteristics.....	7-3	7-5
Destruction.....	15-4	15-8
History.....	2-6	2-4
Manufacture.....	7-3	7-7
Packing.....	14-2	14-1
Reactivity.....	7-3	7-7
Sensitivity.....	7-3	7-8
Shipment.....	14-5	14-10
Specification.....	7-3	7-8
Stability.....	7-3	7-8
Toxicity.....	12-2	12-1
Methyl centralite.....	9-12	9-11
Minol 2		
Brisance.....	8-6	8-125
Characteristics.....	8-6	8-126
Destruction.....	15-3	15-1
History.....	2-7	2-14
Manufacture.....	8-6	8-128
Packing.....	4-2	14-1
Sensitivity.....	8-6	8-128
Shipment.....	14-5	14-10
Stability.....	8-6	8-128
Miporit.....	11-6	11-13
Miscela C.....	11-4	11-8
Motor vehicle transportation of explosives and ammunition.....	14-5	14-12
MS (see mass spectrometry)		
Multiple fragment impact test, propellant.....	6-23	6-4
Muzzle flash.....	9-9	9-8

	<i>Paragraph</i>	<i>Page</i>
NATO tests, pyrotechnic.....	10-3	10-26
NA-OC	11-4	11-8
Neutral grain.....	9-6	9-5
90°C Dutch weight loss test.....	6-19	6-3
Nitrocellulose		
Brisance.....	8-2	8-7
Characteristics.....	8-2	8-2
Destruction	15-3	15-1
History	2-6	2-5
Manufacture.....	8-2	8-4
Packing.....	14-2	14-1
Reactivity.....	8-2	8-7
Sensitivity.....	8-2	8-7
Shipment.....	14-5	14-10
Specification	8-2	8-9
Stability.....	8-2	8-6
Toxicity.....	12-2	12-4
Types.....	8-2	8-3
Nitrogelatedynamit.....	11-9	11-17
Nitroglicol.....	11-4	11-8
Nitroglycerin		
Brisance.....	8-2	8-14
Characteristics.....	8-2	8-9
Destruction	15-4	15-8
History	2-6	2-5
Manufacture.....	8-2	8-10
Reactivity.....	8-2	8-9
Sensitivity.....	8-2	8-13
Shipment.....	14-5	14-10
Specification	8-2	8-13
Stability.....	8-2	8-14
Nitroguanidine		
Brisance.....	8-3	8-45
Characteristics.....	8-3	8-42
Destruction	15-3	15-1
History	2-6	2-7
Manufacture.....	8-3	8-44
Packing.....	14-2	14-1
Reactivity.....	8-3	8-45
Sensitivity.....	8-3	8-44
Shipment.....	14-5	14-10
Specification	8-3	8-43
Stability.....	8-3	8-45
Nitrostarch		
Brisance.....	8-2	8-15
Characteristics.....	8-2	8-15
Destruction	15-3	15-1
History	2-6	2-5
Manufacture.....	8-2	8-15
Packing.....	14-2	14-1
Reactivity.....	8-2	8-15
Sensitivity.....	8-2	8-15
Shipment.....	14-5	14-10
Stability.....	8-2	8-15
Nizol	11-9	11-17

	<i>Paragraph</i>	<i>Page</i>
NMR (see nuclear magnetic resonance)		
Nobelit.....	11-8	11-16
Nobelite galleria.....	11-4	11-8
Nougat.....	11-4	11-8
NO (see nitroguanidine)		
NS (see nitrostarch)		
NSWC small scale gap test.....	5-8	5-7
NTP.....	11-4	11-8
Nuclear magnetic resonance.....	13-5	13-9
Octols		
Brisance.....	8-8	8-114
Characteristics.....	8-6	8-114
Destruction.....	15-3	15-1
History.....	2-9	2-22
Packing.....	14-2	14-1
Sensitivity.....	8-6	8-114
Shipment.....	14-5	14-10
Stability.....	8-6	8-114
Open storage.....	14-4	14-7
Oxidizing agents, pyrotechnic.....	10-1	10-1
Oxiliquite.....	11-4	11-9
Oxilite.....	11-4	11-9
Oxygen balance.....	3-5	3-4
Packing containers for black powder.....	14-2	14-5
Packing containers for explosives, propellants, and ammunition containing explosives.....	14-2	14-5
Packing for explosives and propellants.....	14-2	14-5
Paper chromatography.....	13-3	13-4
Particle velocity.....	4-5	4-3
PBX (see plastic bonded explosives)		
Peak pressure, blast.....	4-6	4-12
Pentaerythritol tetranitrate		
Brisance.....	8-2	8-20
Characteristics.....	8-2	8-16
Destruction.....	15-3	15-1
History.....	2-7	2-16
Manufacture.....	8-2	8-17
Packing.....	14-2	14-1
Reactivity.....	8-2	8-19
Sensitivity.....	8-2	8-19
Shipment.....	4-5	14-10
Specification.....	8-2	8-18
Stability.....	8-2	8-22
Toxicity.....	12-2	12-1
Pentolite		
Brisance.....	8-6	8-119
Characteristics.....	8-6	8-117
Destruction.....	15-3	15-1
Manufacture.....	8-6	8-117
Packing.....	14-2	14-1
Sensitivity.....	8-6	8-117
Shipment.....	14-5	14-10
Specification.....	8-6	8-117
Stability.....	8-6	8-119
Toxicity.....	12-2	12-3

	<i>Paragraph</i>	<i>Page</i>
Pentoriru.....	11-5	11-10
Pentostit.....	11-9	11-17
Pentritolo.....	11-4	11-9
Pentro.....	11-9	11-17
Percussion primers.....	7-9	7-18
PETN (see pentaerythritol tetranitrate)		
Photoflash compositions.....	3-4, 10-1	3-3, 10-6
Picratol		
Brisance.....	8-6	8-121
Characteristics.....	8-6	8-121
Destruction.....	15-3	15-1
Manufacture.....	8-6	8-121
Packing.....	14-2	14-1
Sensitivity.....	8-6	8-121
Shipment.....	14-5	14-10
Stability.....	8-6	8-121
Toxicity.....	12-2	12-3
Plastic bonded explosives.....	8-6	8-129
Plastolit.....	11-9	11-17
PNP esplosivo.....	11-4	11-9
Pobedit VP-4.....	11-6	11-13
Polarography.....	13-4	13-7
Pollution abatement.....	8-6	15-12
Polvere al nitrodigical.....	11-4	11-9
Polvere al nitrometriolo.....	11-4	11-9
Polvere FB.....	11-4	11-9
Polvere FC.....	11-4	11-9
Polvere NAC.....	11-4	11-9
Polvere nera.....	11-4	11-9
Polveri da lancio senza fumo.....	11-4	11-9
Polvoras negras.....	11-7	11-14
Potassium dinitrobenzofuroxane (KDNBF)		
Brisance.....	7-7	7-16
Characteristics.....	7-7	7-16
Destruction.....	15-3	15-1
History.....	2-6	2-8
Packing.....	14-2	14-1
Sensitivity.....	7-7	7-16
Shipment.....	14-5	14-10
Specification.....	7-7	7-17
Stability.....	7-7	7-16
Poudres.....	11-2	11-4
Power, definition.....	3-5	3-4
Primary compositions.....	7-9	7-18
Primary explosive, definition.....	3-4	3-1
Progressive grain.....	9-6	9-5
Propellant charge design.....	9-9	9-7
Propellant compositions.....	9-2	9-1
Propellant grain geometry.....	9-6	9-5
Propellant grains.....	9-4	9-3
Propellant manufacturing.....	9-5	9-3
Propellant, use.....	3-4	3-2
Propelling charges, destruction of.....	15-3	15-7
PVA-LA (see lead azide)		

	<i>Paragraph</i>	<i>Page</i>
PX gap test.....	5-8	5-7
Pyrocellulose (see nitrocellulose)		
Pyrolysis.....	3-5	3-5
Pyrotechnic compositions, classification.....	3-4	3-3
Pyrotechnic devices.....	1 10	10-1
Pyrotechnic materials, destruction of.....	15-3	15-7
Pyroxylin (see nitrocellulose).		
Qxiliquita y aire liquido.....	11-7	11-14
Railroad shipment of explosives and ammunition.....	14-5	14-10
RD1333 (see lead azide)		
RDX (see cyclotrimethylenetrinitramine)		
Reclamation of energetic materials.....	15-6	15-14
Reclamation of propellants.....	15-6	15-14
Reclamation of pyrotechnics.....	15-6	15-14
Relative force.....	9-7	9-6
Relative quickness.....	9-7	9-6
Reolit.....	11-8	11-16
Retardants, pyrotechnic.....	10-1	10-1
Rifle bullet impact test.....	5-16	5-8
Roche.....	11-2	11-4
Runup distance.....	4-4	4-2
Russian energetic materials.....	11-6	11-10
Secondary explosive, definition.....	3-4	3-1
Selectite No.....	11-6	11-13
Sensitivity		
Definition.....	3-5	3-3
Propellant.....	9-11	9-10
Pyrotechnic compositions.....	10-5	10-13
Seramin.....	11-8	11-16
Service tests, pyrotechnic.....	10-3	10-9
Shaped charge effect.....	2-6, 4-7	2-7, 4-14
Shaped charge jet impact test, propellant.....	6-20	6-4
Shaped charge jet spall test, propellant.....	6-21	6-4
Shipment of explosives and ammunition.....	14-5	14-10
Shoanyaku.....	11-5	11-10
Shock sensitivity.....	3-5	3-4
Shock waves.....	4-5	4-3
Shotoyaku.....	11-5	11-10
Signals.....	3-4, 10-1	3-3, 10-2
Single-base propellant.....	3-4, 9-2,	3-2, 9-2,
	9-5	9-3
Single fragment impact test, propellant.....	6-22	6-4
Skid tests.....	5-18	5-9
SLA (see lead azide)		
Slurry explosives, Russian.....	11-6	11-13
Smoke.....	2-2, 2-7	2-1, 2-10
Smoke dyes.....	10-1	10-1
Spanish 'energetic materials.....	11-7	11-13
Spectrometry.....	13-5	13-7
Spectroscopy.....	13-5	13-7
Sprangdeg.....	11-8	11-16

	<i>Paragraph</i>	<i>Page</i>
Spranggelatin.....	1-8	11-16
Stab detonators.....	7-9	7-19
Stability, definition.....	3-5	3-4
Stability, propellant.....	9-12	9-10
Stacking ammunition.....	14-4	14-7
Storage of bulk initiating explosive.....	14-4	14-9
Storage of explosives and ammunition containing explosives.....	14-4	14-6
Storage of propellants.....	14-4	14-9
Strand burner test	6-18	6-3
Surveillance test	6-8	6-2
Surveillance tests, pyrotechnic.....	10-3	10-9
SUSAN test.....	5-17	5-8
Svartkrut	11-8	11-16
Swedish energetic materials.....	11-8	11-14
Swiss energetic materials.....	11-9	11-16
T4 plastico	114	11-9
Tables		
4-1. Unreacted hugoniot data.....		4-6
4-2. Reaction zone length.....		4-10
4-3. Detonation pressures.....		4-11
7-1. Various types of lead azide.....		7-1
7-2. Sensitivity of dry and wet lead azide.....		7-4
7-3. Loading density of mercury fulminate.....		7-5
7-4. Deterioration of mercury fulminate.....		7-9
7-5. Solubility of diazodinitrophenol.....		7-9
7-6. Efficiency of initiating compounds.....		7-11
7-7. High temperature percussion primers.....		7-18
7-8. Percussion priming compositions.....		7-18
7-9. Stab detonator priming compositions.....		7-19
7-10. Electric priming compositions		7-20
8-1. Compositions of mixed acids for nitrating cellulose.....		8-5
8-2. Decomposition of nitrocellulose.....		8-7
8-3. Impact sensitivity of nitroglycerin - acetone mixtures.....		8-14
8-4. Packing density		8-16
8-5. Solubility of PETN in acetone water mixtures.....		8-17
8-6. PETN eutectics		8-17
8-8. Gap test results for PETN.....		8-20
8-9. Detonation velocity versus density.....		8-20
8-10. PETN detonation pressures versus density		8-21
8-11. Solubility of HMX.....		8-27
8-12. Solubility of HMX by volume.....		8-28
8-13. Specific heat of HMX		8-28
8-14. Gap test results for HMX.....		8-29
8-15. Specific heat of RDX		8-30
8-16. RDX packing density.....		8-30
8-17. RDX-TNT solubility		8-32
8-18. Solubility of RDX in various solvents.....		8-33
8-19. Gap test results for RDX		8-35
8-20. Types of RDX		8-37
8-21. Granulation requirements for RDX.....		8-37

Tables (Cont)	<i>Paragraph</i>	<i>Page</i>
8-22. Haleite packing density.....		8-39
8-23. Solubility of nitroguanidine in sulfuric acid.....		8-42
8-24. Gap test results for nitroguanidine.....		8-45
8-25. Density as a function of loading pressure for tetryl.....		8-45
8-26. Dielectric constant of tetryl.....		8-47
8-27. Solubility of tetryl in various solvents.....		8-48
8-28. Heat initiation of tetryl.....		8-51
8-29. Heat initiation of confined tetryl.....		8-51
8-30. Gap test results for tetryl.....		8-52
8-31. Low velocity detonation in tetryl.....		8-53
8-32. Composition of gaseous products of tetryl decomposition.....		8-54
8-33. Composition of condensed phase tetryl.....		8-55
8-34. Density of ammonium picrate.....		8-55
8-35. Solubility of ammonium picrate.....		8-57
8-36. Ammonium picrate explosion temperature.....		8-58
8-37. Gap test results for DATB.....		8-60
8-38. Gap test results for HNAB.....		8-61
8-39. Properties of HNS.....		8-65
8-40. Gap test results for HNS.....		8-66
8-41. Solubility of TATB in various solvents.....		8-66
8-42. Effects of gamma radiation on TATB.....		8-67
8-43. Small scale gap test results for TATB.....		8-71
8-44. Detonation characteristics of TATB.....		8-72
8-45. Effects of moisture on the freezing point of TNT.....		8-74
8-46. Removal of moisture from TNT.....		8-74
8-47. Density as a function of loading pressure for TNT.....		8-74
8-48. Surface tension of liquid TNT.....		8-75
8-49. Dielectric constant of TNT.....		8-75
8-50. Solubility of TNT.....		8-75
8-51. Specific heat, enthalpy, and entropy of TNT.....		8-76
8-52. Thermal diffusivity of TNT.....		8-76
8-53. Isomers of TNT.....		8-83
8-54. Nitrobody concentration for a six nitrator system.....		8-84
8-55. Impurities present in TNT.....		8-85
8-56. Impact sensitivity of TNT.....		8-87
8-57. Gap test results for TNT.....		8-87
8-58. Detonation pressure of TNT.....		8-88
8-59. Fragmentation effects of TNT.....		8-88
8-60. Effects of confinement on TNT detonation products.....		8-89
8-61. Crystal modifications of ammonium nitrate.....		8-92
8-62. Specific heat of ammonium nitrate.....		8-93
8-63. Properties of amatols.....		8-97
8-64. Detonation characteristics of amatols.....		8-98
8-65. Composition A explosives.....		8-100
8-66. Cyclotol properties.....		8-103
8-67. Gap test results for composition B.....		8-105
8-68. Detonation characteristics of composition C explosives.....		8-111
8-69. Properties of octols.....		8-114
8-70. Crater volume in mild steel targets.....		8-116
8-71. Gap tests for 75/25 octol.....		8-116
8-72. Gap test results for 50/50 pentolite.....		8-119
8-73. General characteristics of tetrytols.....		8-122
8-74. High blast explosives.....		8-125
8-75. HTA-3 composition.....		8-126
8-76. PBX compositions.....		8-131
8-77. Compositions and characteristics of dynamites.....		8-133

Tables (Cont)	<i>Paragraph</i>	<i>Page</i>
9-1. Distribution of propellant energy.....	9-1	
9-2. Composition and properties of propellants.....	9-1	
9-3. Burning rate parameters for several standard gun propellants.....	9-7	
10-1. Infrared flare formulas	10-2	
10-2. Red-green flare s) item parts weight.....	10-2	
10-3. Amount of smoke agent per cubic meter of standard smoke.....	10-3	
10-4. Typical formulas for igniter and tracer compositions.....	10-4	
10-5. Properties of pyrophoric metals.....	10-5	
10-6. Maximum volumetric heats of reaction for metals reacting with fluorocarbons	10-5	
10-7. Delay compositions.....	10-6	
10-8. Black powders used in pyrotechnics.....	10-7	
10-9. Ignition mixtures	10-7	
11-1. French secondary explosives.....	11-1	
11-2. French chlorate cheddites.....	11-2	
11-3. French perchlorate cheddites.....	11-3	
11-4. CSE silicon explosives	11-3	
11-5. German secondary explosives.....	11-4	
11-6. Italian explosives.....	11-4	
11-7. Esplosivi da mina gelatinosi con nitroglicerina.....	11-6	
11-8. Esplosivi da mina polverulenti con nitroglicerina.....	11-7	
11-9. Esplosivi da mina polverulenti senza nitroglicerina.....	11-7	
11-10. Japanese explosives.....	11-9	
11-11. Russian explosives.....	11-10	
11-12. Some ammonits formulations.....	11-11	
11-13. Russian brown powders	11-12	
11-14. Russian black powders	11-12	
11-15. Detonity	11-12	
11-16. Granulity	11-13	
11-17. Spanish explosives.....	11-13	
11-18. Spanish artigrisu explosives.....	11-14	
11-19. Swedish explosives	11-15	
11-20. Hexotonal	11-15	
11-21. Swiss explosives.....	11-16	
11-22. Ammonpentritits.....	11-16	
11-23. Penthrinitits	11-17	
12-1. Toxicity of United States Military Explosives.....	12-1	

	<i>Paragraph</i>	<i>Page</i>
Tables (Cont)		
12-15. Deleted		
12-16. Deleted		
12-17. Deleted		
12-18. Deleted		
12-19. Deleted		
12-20. Deleted		
12-21. Deleted		
13-1. Colortests		13-1
13-2. Special correlations of aromatic nitro compounds, nitramines, and nitrates		13-8
14-1. Special requirements for open storage between earth covered magazines		14-8
14-2. Special requirements for open storage between magazines that are not earth covered.....		14-9
15-1. Minimum safe distance between RF transmitters and electric blasting operations.....		15-5
15-2. Minimum safe distances between mobile RF transmitters and electric blasting operations.....		15-5
15-3. Minimum safe distance between TV and FM broadcasting transmitters and electric blasting operations.....		15-6
15-4. Decontaminating chemicals.....		15-9
15-5. High explosive reclamation.....		15-12
15-6. Propellant reclamation.....		15-14
15-7. Pyrotechnic reclamation		15-15
Taliani test	6-16	6-3
TATB (see triamino-trinilrobenzene)		
TEGN (see triethylene glycoldinitrate)		
Temperature and humidity test.....	5-11	5-7
Territ	11-8	11-16
Test		
90°C Dulch weight loss	6-19	6-3
Adiabatic sensitivity	5-19	5-9
Ballistic mortar	3-5	3-4
Ballistic pendulum.....	3-5	3-4
Cap test	6-10	6-2
Card gap test	6-9	6-2
Closed bomb test, propellants.....	6-7	6-1
Compatibility, propellants.....	6-2	6-1
Cook-off temperature test.....	5-6	5-5
Cylinder expansion lest.....	5-21	5-9
Dellagration to detonation transition, propellants.....	6-4	6-1
Detonation velocity test.....	5-5	5-3
Development	10-3	10-9
Dilfferential thermal analysis.....	3-5	3-5
Electrostatic sensitivity.....	3-5, 5-4,	3-4, 5-3,
.....	6-11	6-2
Evaluation.....	10-3	10-9
External heat test. propellants.....	6-3	6-1
Explosion temperature.....	6-17	6-3
Flying plate test	5-9	5-7
Forty foot drop test.....	5-14	5-8
Fragmentation lest.....	5-20	5-9
Friction sensitivity	5-7, 6-12	5-5, 6-2

	<i>Paragraph</i>	<i>Page</i>
Test (cont)		
Gap tests.....	5-8	5-7
Growth and exudation test.....	5-15	5-8
Heat, 100°C and 75°C.....	3-5	3-5
Heat tests, propellants, 134.5°C and 120°C.....	6-5	6-1
High loading rate compression test.....	6-14	6-2
Impact sensitivity	3-5	3-4, 5-2,
.....	6-13	6-2
Incendiary heat output.....	10-3	10-11
Jolt test.....	512	5-7
Jumble test.....	5-13	5-7
KI (potassium iodide).....	3-5	3-5
LANL large scale gap test.....	5-8	5-7
LANL small scale gap test.....	5-8	5-7
LLNL reactivity.....	3-5	3-5
Low loading ratecompression test	6-15	6-2
Malfunction.....	10-3	10-9
Multiple fragment impact test, propellant.....	6-23	6-4
NATO	10-3	10-9
NSWC small scale gap test.....	5-8	5-7
PX gap test.....	5-8	5-7
Pyrolysis.....	3-5	3-5
Pyrotechnic light output.....	10-3	10-9
Pyrotechnic smoke output.....	10-3	10-10
Rifle bullet impact test.....	5-16	5-3
Service.....	10-3	1 0-9
Shaped charge jet impact test, propellant.....	6-20	6-4
Shaped charge jet spall test, propellant.....	6-21	6-4
Shock sensitivity.....	3-5	3-4
Single fragment impact test, propellant.....	6-22	6-4
Skid tests.....	5-18	5-9
Strand burner test.....	6-18	6-3
Surveillance.....	10-3	10-9
Surveillance test.....	6-8	6-2
SUSAN test	5-17	5-8
Taliani test.....	5-16	6-3
Temperature and humidity test.....	5-11	5-7
Thermal sensitivity.....	3-5, 5-8	3-4, 5-7
Thermal gravimetric analysis.....	3-5	3-5
Transport vibration test.....	5-10	5-7
Trauzl lead block test.....	3-5	3-4
Vacuum stability.....	3-5, 5-2,	3-5, 5-2,
.....	6-6	6-1
Tetracene		
Brisance	7-6	7-16
Characteristics	7-6	7-15
Destruction	15-3	15-1
History	2-7	2-9
Manufacture	7-6	7-15
Packing	14-2	14-1
Reactivity	7-6	7-16
Sensitivity	7-6	7-16
Shipment	14-5	14-10
Specification	7-6	7-16
Stability	7-6	7-16
Tetritol	11-7	11-14
Tetritoly.....	11-6	11-13

	<i>Paragraph</i>	<i>Page</i>
Tetryl (see trinitrophenylmelhylnilramine)		
Tetrytols		
Brisance	8-6	8-122
Characteristics	8-6	8-121
Destruction	15-3	15-1
Manufacture	8-6	8-121
Packing	14-2	14-1
Reactivity	8-6	8-122
Sensitivity	8-6	8-122
Shipment	14-5	14-10
Stability	8-6	8-122
Toxicity	12-2	12-3
Thermal conductimetric analysis	10-4	10-12
Thermal gravimetric analysis	3-5	3-5
Thermal sensitivity	3-5	3-4
Thermochemistry, propellants	9-3	9-2
Thermogravimetry, pyrotechnics	10-4	10-12
Thin layer chromatography	13-3	13-4
TMETN (see trimetholethane trinitrate)		
TNT (see trinitrototuenne)		
Tontia	11-7	11-14
Torpex		
Brisance	8-6	8-129
Characteristics	8-6	8-128
Destruction	15-3	15-1
Manufacture	8-6	8-128
Packing	14-2	14-1
Sensitivity	8-6	8-123
Shipment	14-5	14-10
Stability	8-6	8-129
Toxicity	12-2	12-4
Totalit	11-9	11-17
Toxicity	12-2	12-1
Tracers	3-4, 101	3-1, 10-4
Tramex	11-9	11-17
Transport vibration test	5-10	5-7
Trauzl lead block test	3-5	3-4
Triamino-trinitrobenzene		
Brisance	8-4	8-72
Characteristics	8-4	8-66
Destruction	15-3	15-1
Manufacture	8-4	8-70
Packing	14-2	14-1
Sensitivity	8-4	8-71
Shipment	14-5	14-10
Stability	8-4	8-72
Triethylene glycoldinitrate		
Brisance	8-2	8-26
Characteristics	8-2	8-22

	<i>Paragraph</i>	<i>Page</i>
Triethylene glycoldinitrate (Cont)		
Destruction	15-3	15-1
Manufacture.....	8-2	8-25
Packing.....	14-2	14-1
Reactivity.....	8-2	8-22
Sensitivity.....	8-2	8-26
Shipment.....	14-5	14-10
Stability	8-2	8-26
Trimethylolethane trinitrate		
Brisance.....	8-2	8-26
Characteristics.....	8-2	8-26
Destruction	15-3	15-1
Manufacture.....	8-2	8-26
Packing.....	14-2	14-1
Reactivity.....	8-2	8-26
Sensitivity.....	8-2	8-26
Shipment.....	14-5	14-10
Stability.....	8-2	8-27
Trinitrophenylmethylnitramine		
Brisance.....	8-3	8-52
Characteristics	8-3	8-45
Destruction	15-3	15-1
History	2-6	2-7
Manufacture.....	8-3	8-49
Packing.....	14-2	14-1
Reactivity.....	8-3	8-48
Sensitivity.....	8-3	8-51
Shipment.....	14-5	14-10
Stability.....	8-3	8-55
Toxicity.....	12-2	12-1
Trinitrotoluene		
Brisance.....	8-4	8-88
Characteristics.....	8-4	8-72
Destruction	1-3	15-1
History	2-6, 2-7	2-6, 2-8
Manufacture.....	8-4	8-83
Packing.....	14-2	14-1
Reactivity.....	8-4	8-77
Sensitivity.....	8-4	8-87
Shipment.....	14-5	14-10
Specification.....	8-4	8-86
Stability.....	8-4	8-89
Toxicity.....	12-2	12-3
Triplastita.....	11-7	11-14
Triple-base propellant.....	3-4, 9-2,	3-2, 9-2,
.....	9-5	9-4
Tritolita.....	11-7	11-14
Tritolital	11-7	11-14
Tritonal		
Brisance	8-6	8-123
Characteristics	8-6	8-123
Destruction	5-3	15-1
Manufacture	8-6	8-123
Packing.....	14-2	14-1
Reactivity	8-6	8-123
Sensitivity	8-6	8-123

	<i>Paragraph</i>	<i>Page</i>
Tritonal (Cont)		
Shipment.....	14-5	14-10
Stability	8-6	8-123
Toxicity	12-2	12-4
Uglenity	11-6	11-13
Ultraviolet spectroscopy.....	13-5	13-7
Umbrite	11-4	11-9
Vacuum stability test		
Definition	3-5	3-5
Explosives	5-2	5-2
Propellants	6-6	6-1
Visible spectroscopy.....	13-5	13-7
Waste recycling	15-6	15-12
Water shipment of explosives and ammunition.....	14-5	14-15
Waterproofing agents, pyrotechnic.....	10-1	10-1
Web	9-6	9-5
Wet chemical identification methods.....	13-2	13-1
White smoke	3-4, 10-1	3-3, 10-2
Zemogranoolity	11-6	11-13

By Order of the Secretary of the Army:

JOHN A. WICKHAM, JR.
General, United States Army
Chief of Staff

ROBERT M. JOYCE
Major General, United States Army
The Adjutant General

Distribution:

To be distributed in accordance with DA Form 12-40, Requirements for Section IV, General Information Applicable to All Organizations Which Have a Conventional Munitions Mission.

☆U.S. Government Printing Office: 1995 -- 388-421/140013

RECOMMENDED CHANGES TO EQUIPMENT TECHNICAL PUBLICATIONS

 <div style="border: 1px solid black; border-radius: 15px; padding: 5px; display: inline-block; margin-left: 20px;"> <p style="margin: 0;"><i>THEN...JOT DOWN THE DOPE ABOUT IT ON THIS FORM. CAREFULLY TEAR IT OUT, FOLD IT AND DROP IT IN THE MAIL.</i></p> </div>		SOMETHING WRONG WITH PUBLICATION		
		FROM: (PRINT YOUR UNIT'S COMPLETE ADDRESS)		
PUBLICATION NUMBER		DATE SENT		
PUBLICATION DATE		PUBLICATION TITLE		
BE EXACT PIN-POINT WHERE IT IS				
PAGE NO.	PARA- GRAPH	FIGURE NO.	TABLE NO.	<p style="text-align: center; font-weight: bold; margin-top: 0;">IN THIS SPACE, TELL WHAT IS WRONG AND WHAT SHOULD BE DONE ABOUT IT.</p>
PRINTED NAME, GRADE OR TITLE AND TELEPHONE NUMBER			SIGN HERE	

The Metric System and Equivalents

Linear Measure

1 centimeter = 10 millimeters = .39 inch
 1 decimeter = 10 centimeters = 3.94 inches
 1 meter = 10 decimeters = 39.37 inches
 1 dekameter = 10 meters = 32.8 feet
 1 hectometer = 10 dekameters = 328.08 feet
 1 kilometer = 10 hectometers = 3,280.8 feet

Weights

1 centigram = 10 milligrams = .15 grain
 1 decigram = 10 centigrams = 1.54 grains
 1 gram = 10 decigrams = .035 ounce
 1 decagram = 10 grams = .35 ounce
 1 hectogram = 10 decagrams = 3.52 ounces
 1 kilogram = 10 hectograms = 2.2 pounds
 1 quintal = 100 kilograms = 220.46 pounds
 1 metric ton = 10 quintals = 1.1 short tons

Liquid Measure

1 centiliter = 10 milliliters = .34 fl. ounce
 1 deciliter = 10 centiliters = 3.38 fl. ounces
 1 liter = 10 deciliters = 33.81 fl. ounces
 1 dekaliter = 10 liters = 2.64 gallons
 1 hectoliter = 10 dekaliters = 26.42 gallons
 1 kiloliter = 10 hectoliters = 264.18 gallons

Square Measure

1 sq. centimeter = 100 sq. millimeters = .155 sq. inch
 1 sq. decimeter = 100 sq. centimeters = 15.5 sq. inches
 1 sq. meter (centare) = 100 sq. decimeters = 10.76 sq. feet
 1 sq. dekameter (are) = 100 sq. meters = 1,076.4 sq. feet
 1 sq. hectometer (hectare) = 100 sq. dekameters = 2.47 acres
 1 sq. kilometer = 100 sq. hectometers = .386 sq. mile

Cubic Measure

1 cu. centimeter = 1000 cu. millimeters = .06 cu. inch
 1 cu. decimeter = 1000 cu. centimeters = 61.02 cu. inches
 1 cu. meter = 1000 cu. decimeters = 35.31 cu. feet

Approximate Conversion Factors

To change	To	Multiply by	To change	To	Multiply by
inches	centimeters	2.540	ounce-inches	Newton-meters	.007062
feet	meters	.305	centimeters	inches	.394
yards	meters	.914	meters	feet	3.280
miles	kilometers	1.609	meters	yards	1.094
square inches	square centimeters	6.451	kilometers	miles	.621
square feet	square meters	.093	square centimeters	square inches	.155
square yards	square meters	.836	square meters	square feet	10.764
square miles	square kilometers	2.590	square meters	square yards	1.196
acres	square hectometers	.405	square kilometers	square miles	.386
cubic feet	cubic meters	.028	square hectometers	acres	2.471
cubic yards	cubic meters	.765	cubic meters	cubic feet	35.315
fluid ounces	milliliters	29.573	cubic meters	cubic yards	1.308
pints	liters	.473	milliliters	fluid ounces	.034
quarts	liters	.946	liters	pints	2.113
gallons	liters	3.785	liters	quarts	1.057
ounces	grams	28.349	liters	gallons	.264
pounds	kilograms	.454	grams	ounces	.035
short tons	metric tons	.907	kilograms	pounds	2.205
pound-feet	Newton-meters	1.356	metric tons	short tons	1.102
pound-inches	Newton-meters	.11296			

Temperature (Exact)

°F	Fahrenheit temperature	5/9 (after subtracting 32)	Celsius temperature	°C
----	------------------------	----------------------------	---------------------	----

